

Contents

1	PLL2203SR	Silicone Lens for Windows & Doors Applications	Pag. 2
2	KEL2203	Holder	Pag. 3
3	Application examples		Pag. 4
4	Assembly Specifications		Pag. 5
5	IK Tests		Pag. 6
6	IP X5 Test		Pag. 7
7	Test circuits made by Khatod		Pag. 8
8	Materials / Use and Maintenance / Disclaimer		Pag. 9

PLL2203SR Lens enables to illuminate windows and doors by emphasizing the frame structure thanks to its excellent blade-shape beam.

- Optical design ensures high performance.
- Small size and snail shape make it unobtrusive and elegant. Perfect for architectural lighting, outdoor and Indoor.
- Available with holder. When assembling the parts, the LEDs must be lined up in a single row under the lens.
- Mounted at the centre of the bottom or top or side edge of windows or doors, it creates a great graphic lighting effect and enables to customize the illumination of the applied environment.
- Made of silicone, ensures great resistance to water and powder penetration, to impacts and extreme temperatures.

PLL2203SR + KEL2203 - Windows & Doors Lens

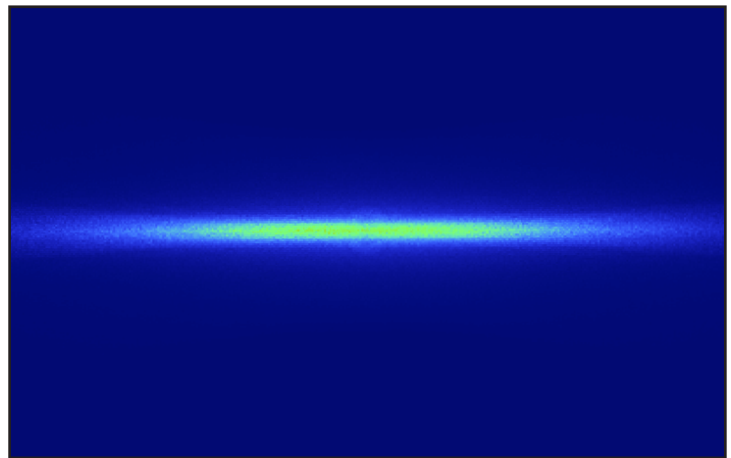
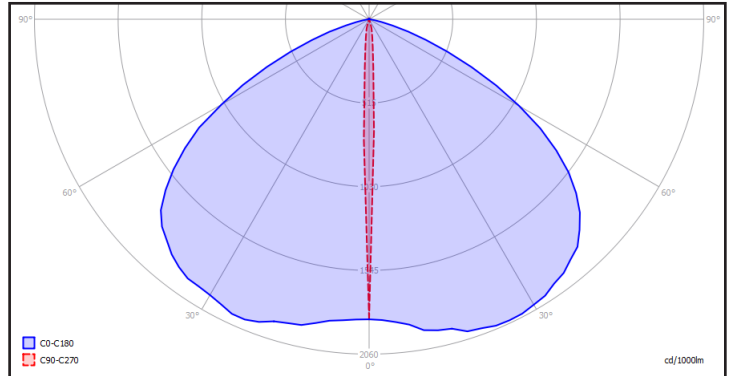
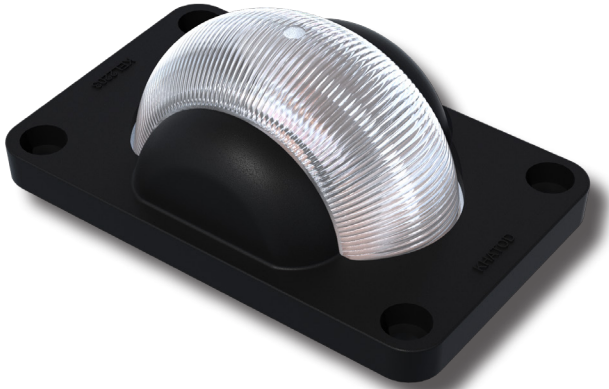

Product images are for illustrative purposes only

- Material = PC for Holder, **SILICONE** for Lens
- Full angle at 50% from maximum: ~ 4°x120°
- Full angle at 10% from maximum: ~ 13°x150°
- The light spots here represented refer to tests carried out with **1.6x1.6mm LEDs**, and ~358Lumen@LED

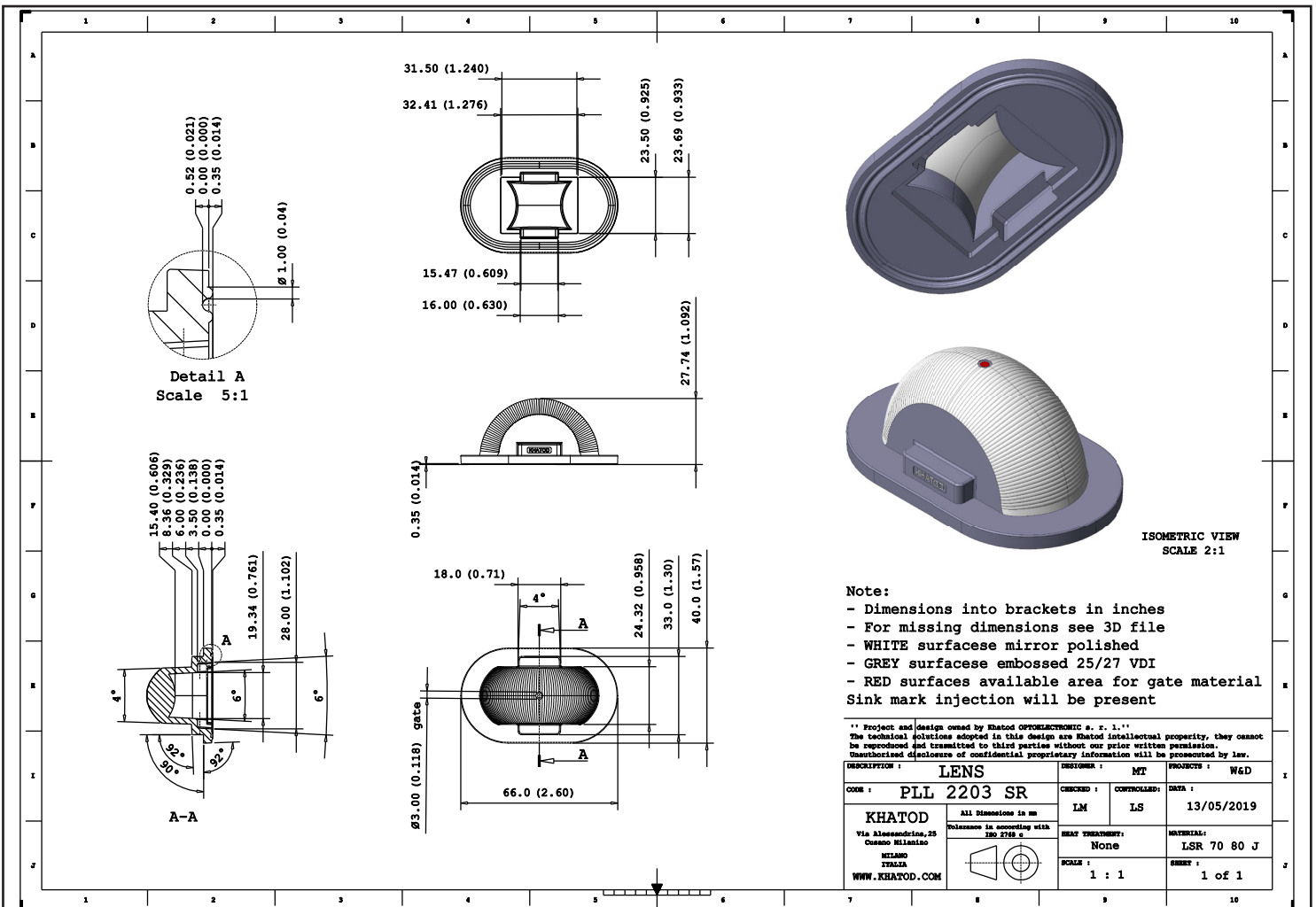

KEL2203 - Holder

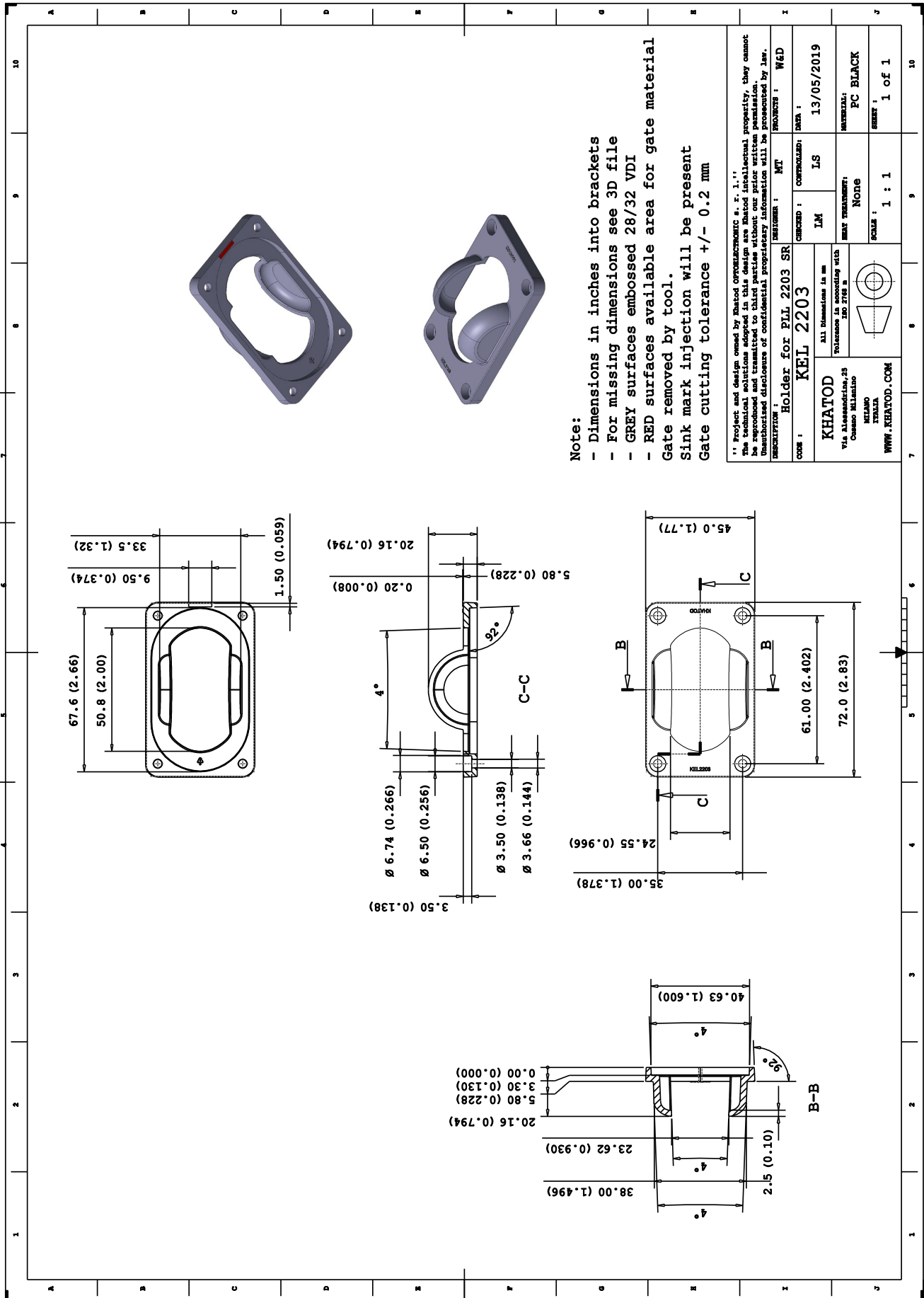

Application examples

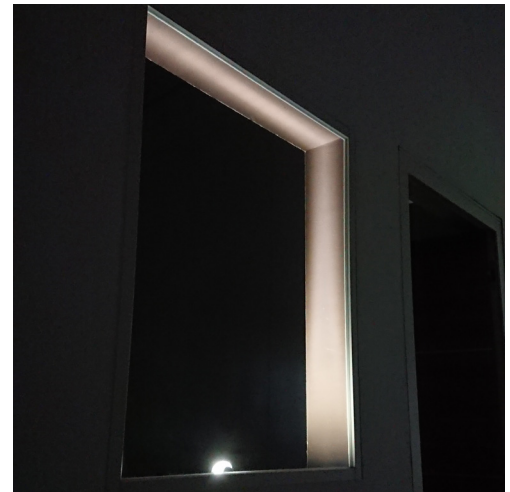
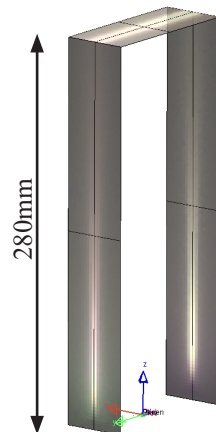
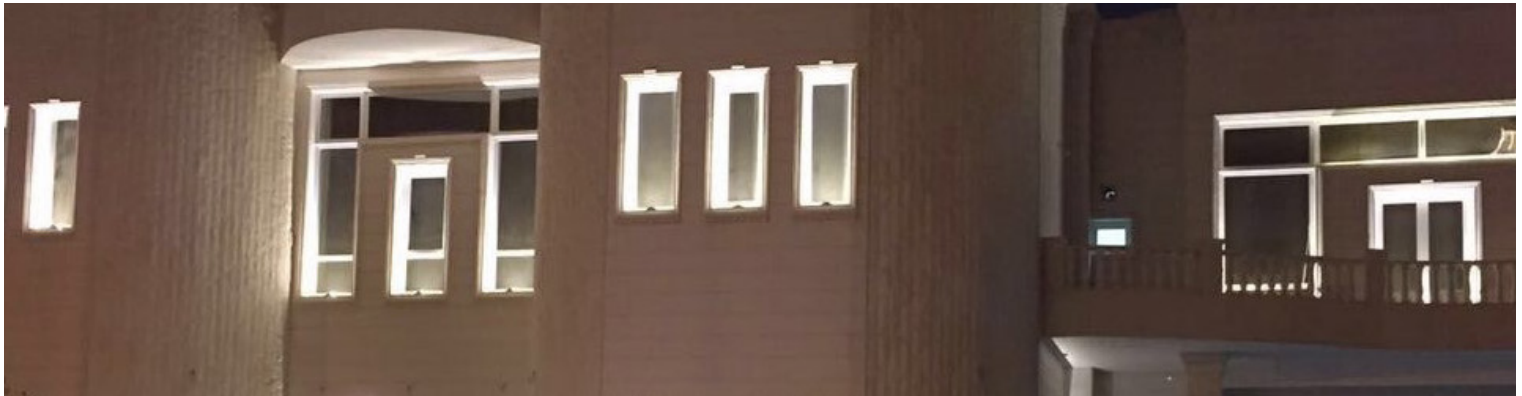

Assembly Specifications

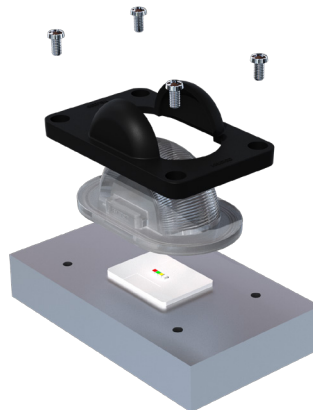
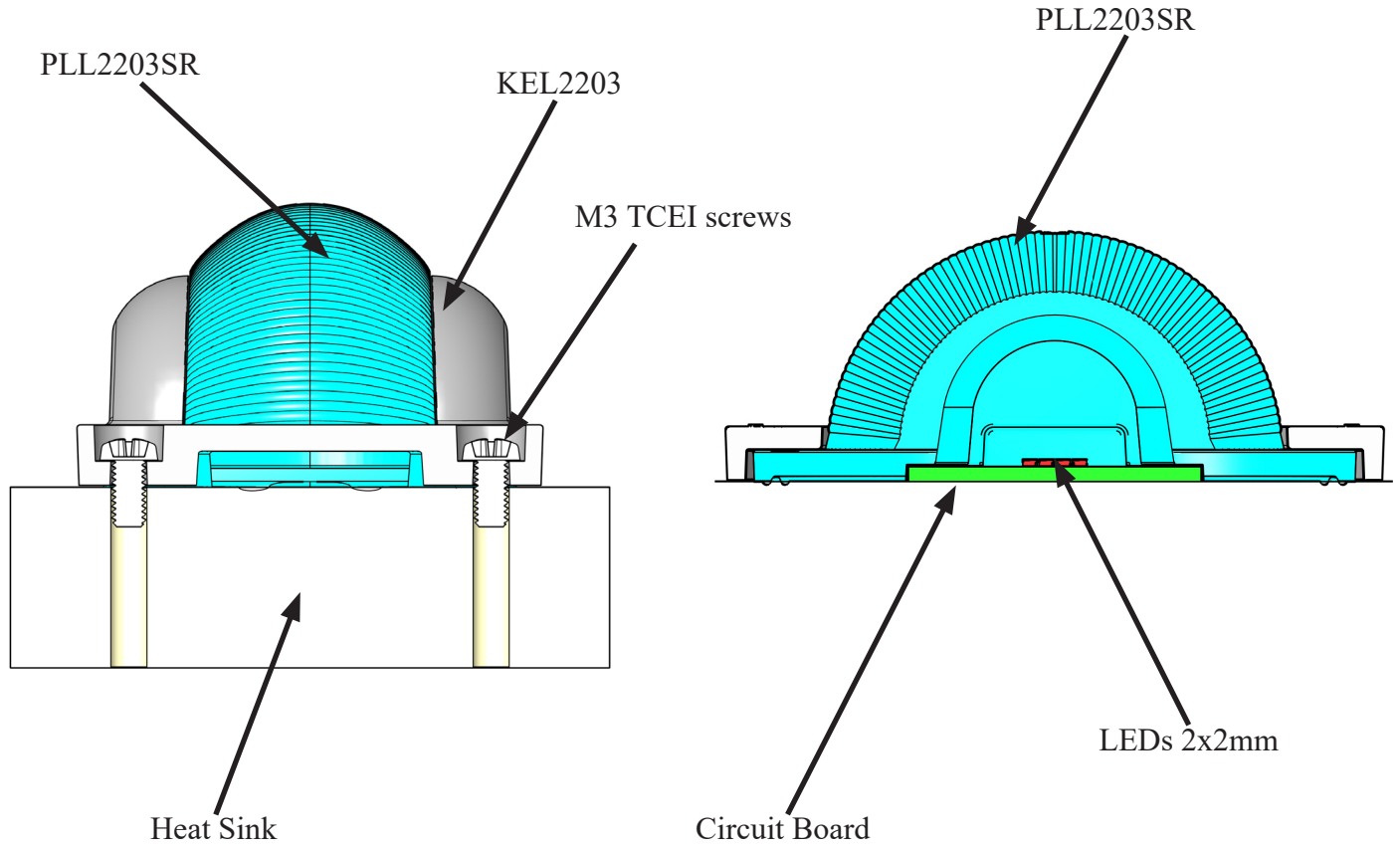

Use M3 TCEI screws
M3: Maximum tightening torque ~ 0.9 Nm

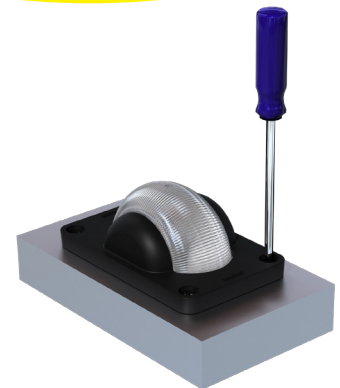

Determination of mechanical impact resistance degree (IK tests)

Note

The present document is an internal document showing the tests carried out by Khatod in its laboratory. The tests, photos and videos presented in this document are made available for demonstration purposes only. Khatod, with its laboratory, is not a certification body. If customers need IK accredited certifications, they have to apply to the appointed Certification Bodies, under their sole care and responsibility.

Initial Visual Inspection

- Before starting with testing, a visual inspection was performed in order to check the integrity of the part under test. The part resulted physically intact.

Tests Execution

Tests were carried out on the part under test according to IK10 (20 Joule)
Test parameters are as follows:

- Impact energy: 20 Joule
- Impacting element: 5.000 grams
- Distance between impacting element and the part under test: 40 cm
- Number of impacts: 5

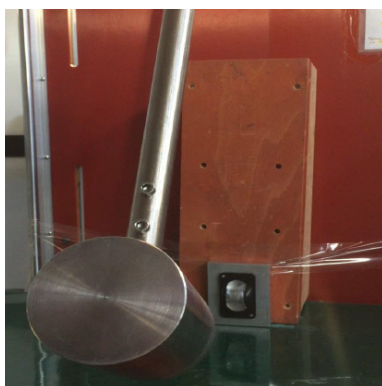
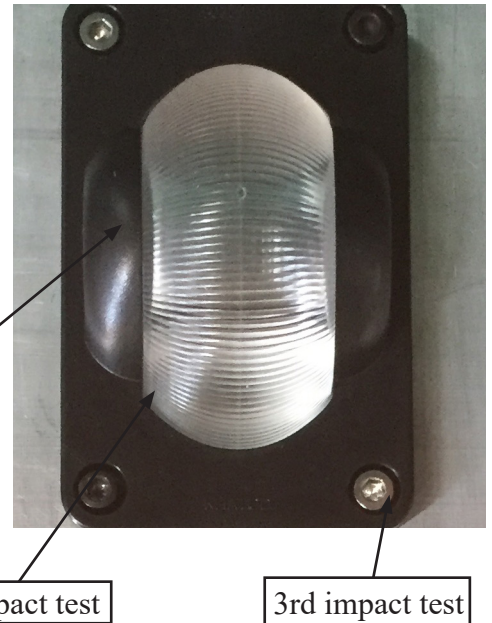

1st TEST

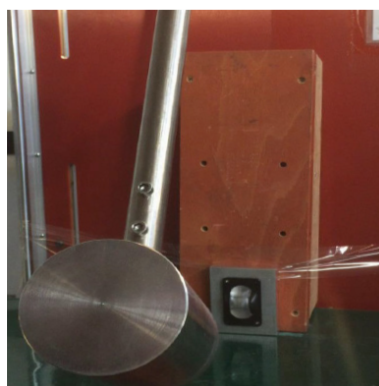

2nd TEST

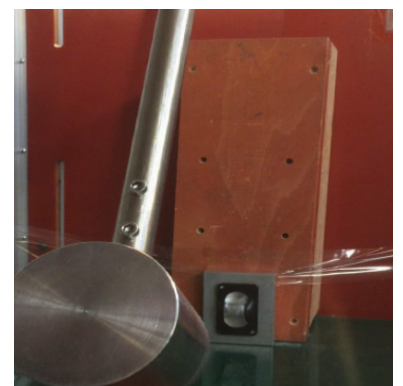

3rd TEST

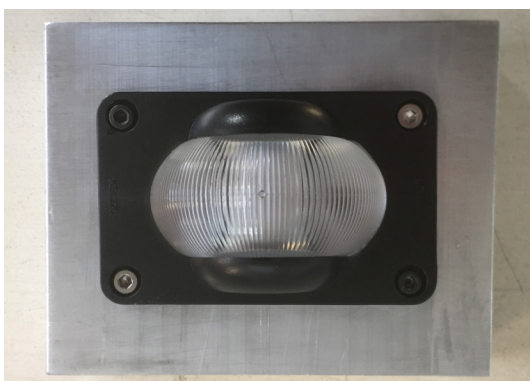

Final Visual Inspection:
After testing, a final visual inspection was performed.
The result was positive. (view photo)

IP X5 Test

Note

The present document is an internal document showing the tests carried out by Khatod in its laboratory. The tests, photos and videos presented in this document are made available for demonstration purposes only. Khatod, with its laboratory, is not a certification body.

If customers need IP accredited certifications, they have to apply to the appointed Certification Bodies, under their sole care and responsibility.

Data and Analysis

The sample has been subjected to the water-penetration resistance test as follows:

- Assembly of the components to test :
A moisture indicator paper sheet has been interposed between the lens and the clamping base
- Positioning of the assembled sample under the device of watering with nozzle Ø 6.3 millimeters
- Water flow: 12.5 l/min \pm 5%
- Water pressure: 30 kPa @ distance of 3m
- Duration of water spraying test on the wrap surface per m² : 1 min
- Minimum duration of the test: 3 min
- Distance between the nozzle and the wrap surface: 2.5 Meters

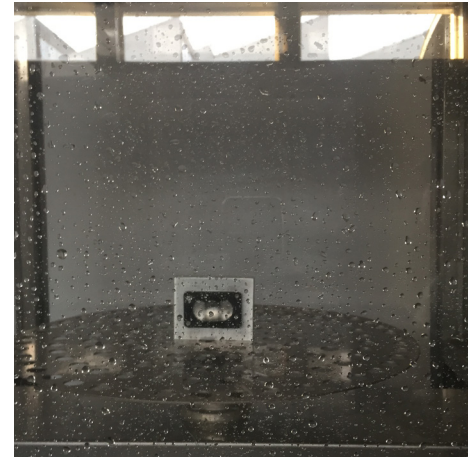
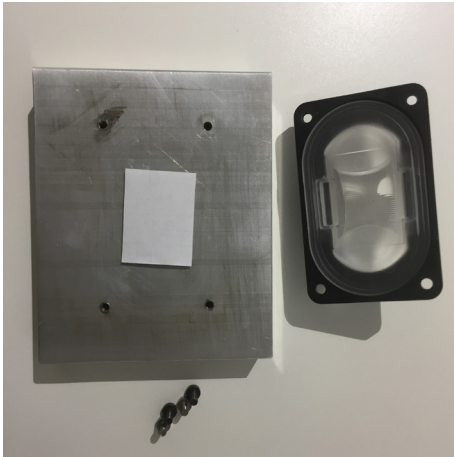

Testing under water jet

Conclusion

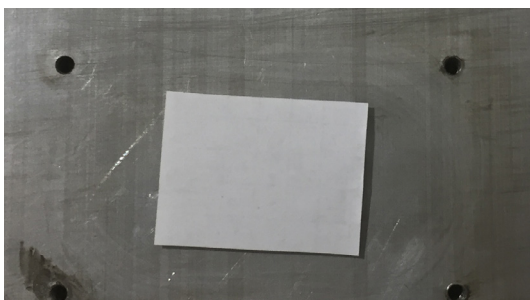

The test paper sheet is dry

As shown in the photo, the test paper sheet is completely dry after disassembling the system.

Based on the water penetration resistance test, PLL2203SR proved to be fit for purpose.

The product has passed the Khatod test.

Customize your colors

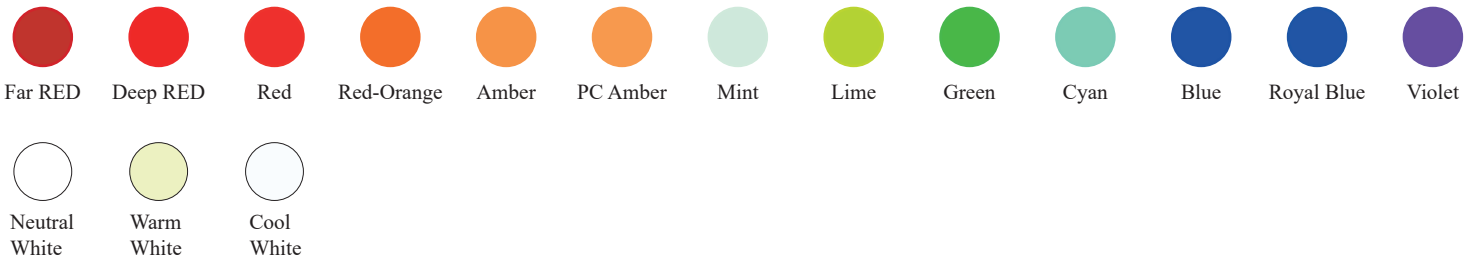

The wide variety of LEDs currently available on the market enables to customize the LED clusters with multiple colors. PLL2203SR lens from Khatod allows to use clusters made up to 4 LEDs with 2x2mm case. The customers are given the the opportunity to choose the color that best meets their requirements and make the difference with the standard proposals.

Here below, you will find an example about using PLL2203SR lens by customizing the light color without penalizing the optical performance.

Example of a Linear made of 4 Cree XQ-E HI LEDs and using 4 different colors.

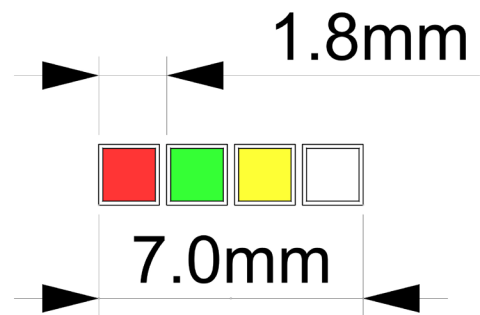

LEDs: 1 Red 3 Yellow
 2 Green 4 White

Test circuits made by Khatod

To make the tests easier for the customers, Khatod has created a PCB: KFP45_REV1. Circuit diagrams and photos are shown below.

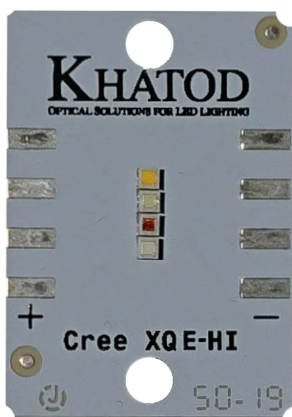

KFP45_REV1

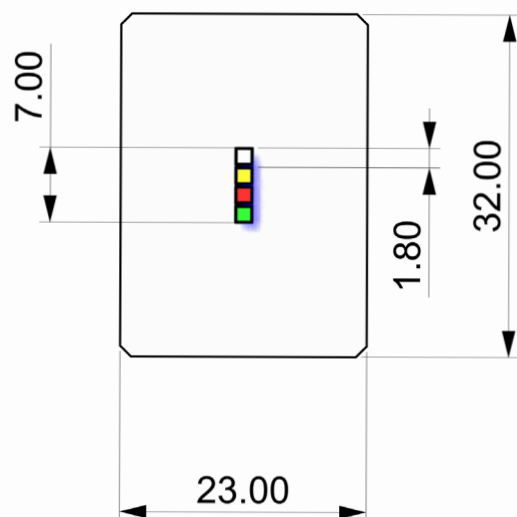

Materials

Material	Top
SILICONE for Lens	-40° ...150°C
PC for Holder	-40° ...120°C

Notes:

- The optical values shown are the result of optical simulations carried out with LIGHTTOOLS, ASAP and ZEMAX software systems. The optical simulations are carried out on the basis of the typical values provided in the LED manufacturers' official datasheets. The photometric analysis has been carried out on physical samples. On request, by supplying your PCB, we can provide the measurement photometric file.

Use and Maintenance

- DO NOT HANDLE OR INSTALL LENSES WITHOUT WEARING GLOVES, SKIN OILS MAY DAMAGE LENS OR LIGHT TRANSMISSION;
- CLEAN LENSES WITH MILD SOAP AND WATER AND A SOFT CLOTH;
- DO NOT USE ANY COMMERCIAL CLEANING SOLVENTS ON LENSES.

Disclaimer

Please note that flow lines and weld lines on the external surfaces of the lenses are acceptable if the optical performance of the lens is within the specifications.

Should you require further information, please contact Khatod for advice. All lens testing must be subject to identical conditions as Khatod test condition. Khatod Optoelectronic, Milan, Italy, manufactures lenses for LEDs. Any other use of the lens shall void our liability and warranty. The lenses are an inert component to be used in the manufacture of various products. Our warranty and liability are limited only to the manufacture of the lens. You may not modify, copy, distribute reproduce, license or alter the lens and related materials of Khatod. Khatod does not warrant against damages or defects arising out of the use or misuse of the products; against defects or damage arising from improper installation, or against defects in the product or in its components. No warranty of any kind, expressed or implied, is made regarding the safety of the products. The entire risk as to the quality or performance of the product is with the buyer. In no event shall Khatod be liable for any direct, indirect, punitive, incidental, special, consequential damages, or any damages whatsoever arising out of or connected with the use or misuse of the product. Khatod shall not have any obligation with respect to the product or any part thereof, whether based on contract, tort, strict liability or otherwise. Buyer assumes all risks and liability from use of the product. The laws of Milan, Italy govern this product warranty and liability and you hereby consent to the exclusive jurisdiction and venue of courts in Milan, Italy in all disputes arising out of or relating to the use of this product. Production, marketing, distribution, sale of these products as well as their possible modifications and variations are only exclusive right of Khatod Optoelectronic. No company can perform any of these actions without written permission released by Khatod Optoelectronic. The information contained in this document is proprietary of Khatod Optoelectronic and may change without notice.

REPRODUCTION PROHIBITED.