

1.2A, Ultra-Low Dropout Linear Regulator with Enable

General Description

The RT2518 is a high performance positive voltage regulator designed for applications requiring ultra-low input voltage and ultra-low dropout voltage at up to 1.2 amperes. It operates with an input voltage as low as 1.4V, and the output voltage is adjustable as low as 0.5V. The RT2518 features ultra low dropout, ideal for applications where output voltage is very close to input voltage. Additionally, the RT2518 has an enable pin to further reduce power dissipation while shutdown. The RT2518 provides excellent regulation over variations in line, load and temperature. The RT2518 is available in the WDFN-8L 3x3 package.

Ordering Information

RT2518□□

- Package Type
QW : WDFN-8L 3x3 (W-Type)
- Lead Plating System
G : Green (Halogen Free and Pb Free)

Note :

Richtek products are :

- ▶ RoHS compliant and compatible with the current requirements of IPC/JEDEC J-STD-020.
- ▶ Suitable for use in SnPb or Pb-free soldering processes.

Marking Information

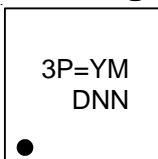

3P= : Product Code
YMDNN : Date Code

Features

- Input Voltage as Low as 1.4V
- Ultra-Low Dropout Voltage 200mV @ 1.2A
- Adjustable Output Voltage from 0.5V to 5.5V
- Over-Current Protection
- Over-Temperature Protection
- 1μA Input Current in Shutdown Mode
- Enable Control

Applications

- Telecom/Networking Cards
- Motherboards/Peripheral Cards
- Industrial Applications
- Wireless Infrastructures
- Set-Top Boxes
- Medical Equipments
- Notebook Computers
- Battery Powered Systems

Pin Configuration

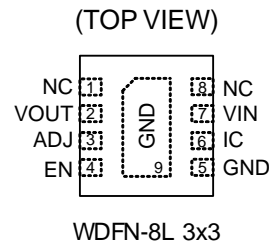

Simplified Application Circuit

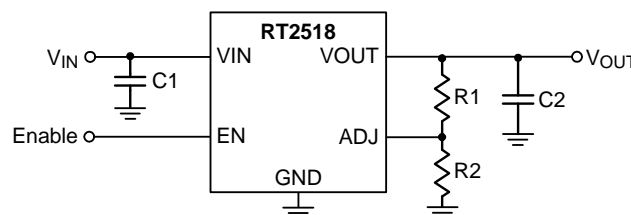

Functional Pin Description

Pin No.	Pin Name	Pin Function
1, 8	NC	No internal connection.
2	VOUT	Output voltage. A minimum of 10 μ F capacitor should be placed directly at this pin.
3	ADJ	Feedback voltage input. If external feedback resistors are used, the output voltage will be determined by the resistor ratio.
4	EN	Enable control input (Active-High). Pulling this pin below 0.4V turns the regulator off, reducing the quiescent current to a fraction of its operating value. The device will be enabled if this pin is left open. Connect to VIN if not used.
5, 9 (Exposed pad)	GND	Ground. The exposed pad must be soldered to a large PCB and connected to GND for maximum power dissipation.
6	IC	Internal connection. Leave floating and do not make connection to this pin.
7	VIN	Power input. For regulation at full load, the input to this pin must be between (VOUT + 0.4V) and 6V. Minimum input voltage is 1.4V. A large bulk capacitance should be placed closely to this pin to ensure that the input supply does not sag below 1.4V. Also, a minimum of 10 μ F ceramic capacitor should be placed directly at this pin.

Functional Block Diagram

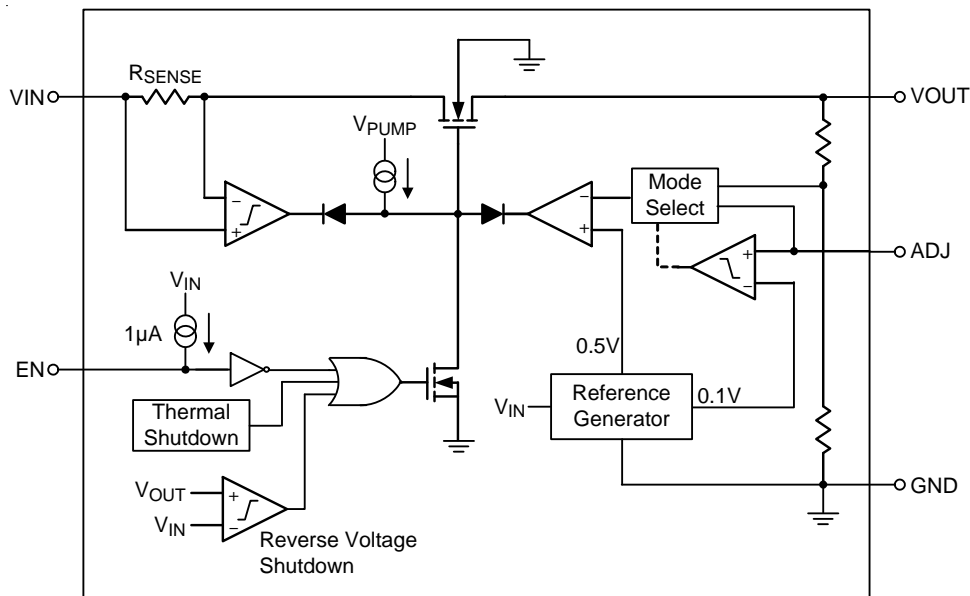

Operation

The RT2518 is a low input voltage low dropout LDO that can support the input voltage range from 1.4V to 6V and the output current can be up to 1.2A. The RT2518 uses internal charge pump to achieve low input voltage operation and the internal compensation network is well designed to achieve fast transient response with good stability.

In steady-state operation, the feedback voltage is regulated to the reference voltage by the internal regulator. When the feedback voltage signal is less than the reference, the on resistance of the power MOSFET is decreased to increase the output current through the power MOSFET, and the feedback voltage will be charge back to reference. If the feedback voltage is less than the reference, the power MOSFET current is decreased to make the output voltage discharge back to reference by the loading current.

Reverse Current Protection

The reverse current protection is guarantee by the N-MOSFET with bulk capacitors connected to GND and the internal circuit. The reverse voltage detection circuit shuts the total loop down if the output voltage is higher than input voltage.

Output Under-Voltage Protection (UVP) and Over-Current Fold-Back

When the feedback voltage is lower than 0.15V after internal soft-start end, the UVP is triggered. If the over-current condition is triggered during UVP state, the OC limit current will be decreased to limit the output power and change into re-soft start state at the same time.

Soft-Start

At start-up, an internal current source charges an internal capacitor to build the soft-start ramp voltage.

The output tracks the internal soft-start ramp voltage, which limits the input inrush current.

The output ramp-up time proportional to the targeted regulation voltage. With an output voltage range of 0.5V to 5V, the typical ramp-up time will be around 50μs to 400μs, correspondingly.

Over-Temperature Protection (OTP)

The RT2518 has an over-temperature protection. When the device triggers the OTP, the device shuts down until the temperature back to normal and move to re-soft start state.

Absolute Maximum Ratings (Note 1)

- Supply Voltage, V_{IN} ----- -0.3V to 7V
- Other Pins ----- -0.3V to 7V
- Power Dissipation, P_D @ $T_A = 25^\circ\text{C}$
 WDFN-8L 3x3 ----- 2.08W
- Package Thermal Resistance (Note 2)
 WDFN-8L 3x3, θ_{JA} ----- 49°C/W
 WDFN-8L 3x3, θ_{JC} ----- 8°C/W
- Lead Temperature (Soldering, 10 sec.) ----- 260°C
- Junction Temperature ----- 150°C
- Storage Temperature Range ----- -65°C to 150°C
- ESD Susceptibility (Note 3)
 HBM (Human Body Model) ----- 2kV
 CDM (Charged Device Model) ----- 1kV

Recommended Operating Conditions (Note 4)

- Supply Voltage, V_{IN} ----- 1.4V to 6V
- Junction Temperature Range ----- -40°C to 125°C

Electrical Characteristics

($V_{IN} = 1.4\text{V}$ to 6V , $I_{OUT} = 10\mu\text{A}$ to 1.2A , $V_{ADJ} = V_{OUT}$, $-40^\circ\text{C} \leq T_A \leq 85^\circ\text{C}$, unless otherwise specified)

Parameter	Symbol	Test Conditions	Min	Typ	Max	Unit
Quiescent Current	I_Q	$V_{IN} = 3.3\text{V}$, $I_{OUT} = 0\text{A}$	--	0.7	1.5	mA
Shutdown Current	I_{SHDN}	$V_{IN} = 5.5\text{V}$, $V_{EN} = 0\text{V}$	--	1.5	10	μA
Line Regulation	ΔV_{LINE}	$I_{OUT} = 10\text{mA}$	--	0.2	0.4	%/V
Load Regulation	ΔV_{LOAD}	$I_{OUT} = 10\text{mA}$ to 1.2A	--	0.5	1.5	%
Dropout Voltage	V_{DROP}	$I_{OUT} = 1.2\text{A}$, $V_{IN} \geq 1.55\text{V}$	--	120	200	mV
		$I_{OUT} = 1.2\text{A}$, $1.4\text{V} < V_{IN} < 1.55\text{V}$	--	--	350	
		$I_{OUT} = 0.6\text{A}$, $V_{IN} \geq 1.55\text{V}$	--	60	100	
		$I_{OUT} = 0.6\text{A}$, $1.4\text{V} < V_{IN} < 1.55\text{V}$	--	--	175	
Current Limit	I_{LIM}	$V_{IN} = 3.3\text{V}$	1.4	1.6	--	A
Feedback						
ADJ Reference Voltage	V_{ADJ}	$V_{IN} = 3.3\text{V}$, $V_{ADJ} = V_{OUT}$, $I_{OUT} = 10\text{mA}$, $T_A = 25^\circ\text{C}$	0.495	--	0.505	V
		$V_{IN} = 3.3\text{V}$, $V_{ADJ} = V_{OUT}$, $I_{OUT} = 10\text{mA}$	0.4925	--	0.5075	
ADJ Input Current	I_{ADJ}	$V_{ADJ} = 0.5\text{V}$	--	20	200	nA

Parameter	Symbol	Test Conditions	Min	Typ	Max	Unit	
Enable							
EN Current	I_{EN}	$V_{EN} = 0V, V_{IN} = 5.5V$	--	1	10	μA	
EN Input Voltage	Logic-High	V_{IH}	$V_{IN} = 3.3V$	1.33	--	--	V
	Logic-Low	V_{IL}	$V_{IN} = 3.3V$	--	--	0.4	
AC Parameters							
Ripple Rejection	PSRR	$V_{IN} = 3.3V, V_{OUT} = 1.8V, I_{OUT} = 0.5A,$ $f = 120Hz, C_{IN} = C_{OUT} = 10\mu F$	--	63	--	dB	
		$V_{IN} = 3.3V, V_{OUT} = 1.8V, I_{OUT} = 0.5A,$ $f = 1kHz, C_{IN} = C_{OUT} = 10\mu F$	--	56	--		
Output Noise Density	$p_n(l/f)$	$f = 120Hz, C_{OUT} = 10\mu F$	--	0.8	--	$\mu V/\sqrt{Hz}$	
Output Noise Voltage	e_n	$V_{IN} = 3.3V, V_{OUT} = 1.8V, C_{OUT} = 10\mu F,$ $BW = 100Hz - 100kHz$	--	80	--	$\mu V(rms)$	
Over-Temperature Protection							
OTP Threshold			--	160	--	$^{\circ}C$	
OTP Hysteresis			--	30	--	$^{\circ}C$	

Note 1. Stresses beyond those listed “Absolute Maximum Ratings” may cause permanent damage to the device. These are stress ratings only, and functional operation of the device at these or any other conditions beyond those indicated in the operational sections of the specifications is not implied. Exposure to absolute maximum rating conditions may affect device reliability.

Note 2. θ_{JA} is measured at $T_A = 25^{\circ}C$ on a high effective thermal conductivity four-layer test board per JEDEC 51-7. θ_{JC} is measured at the exposed pad of the package.

Note 3. Devices are ESD sensitive. Handling precaution is recommended.

Note 4. The device is not guaranteed to function outside its operating conditions.

Typical Application Circuit

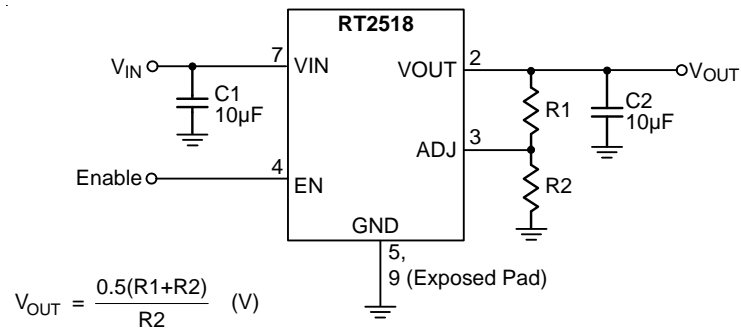
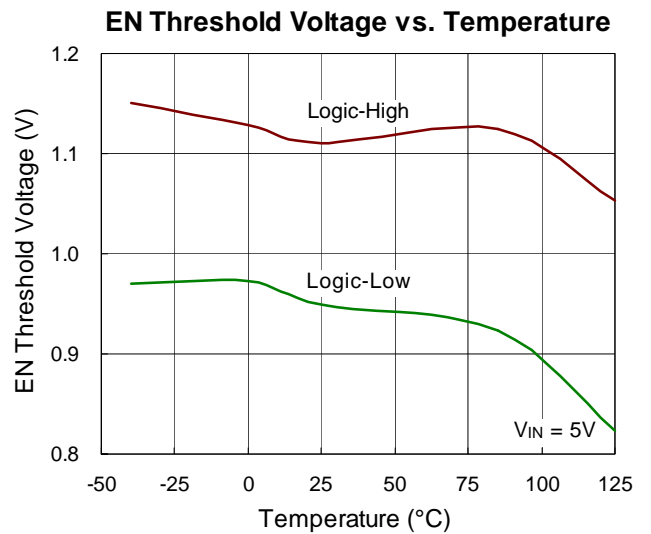
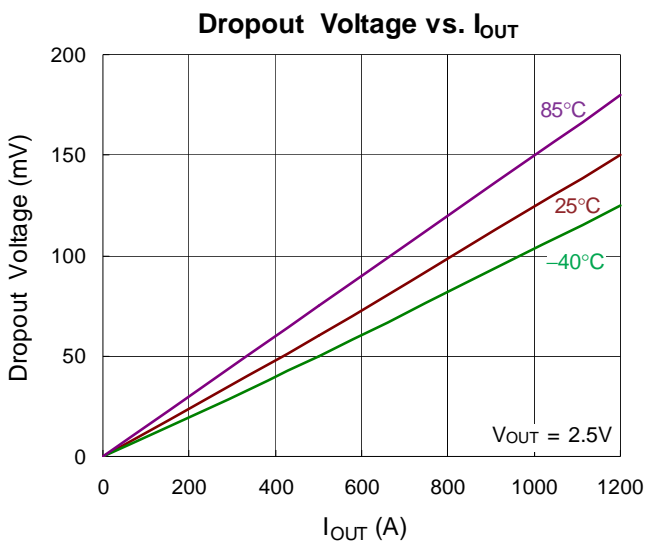
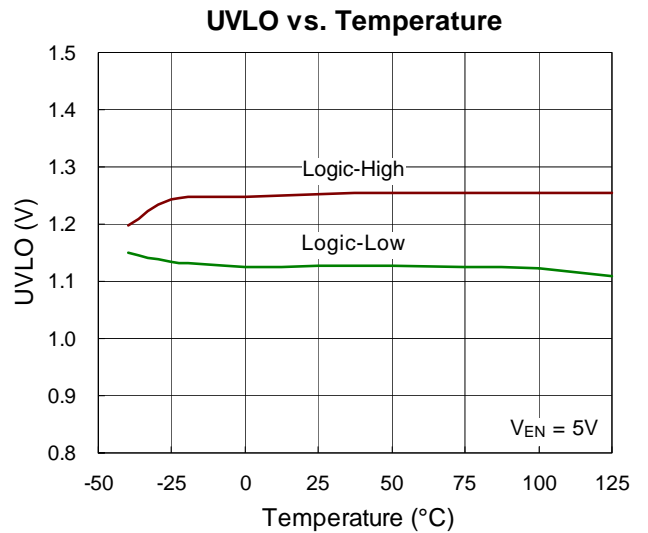
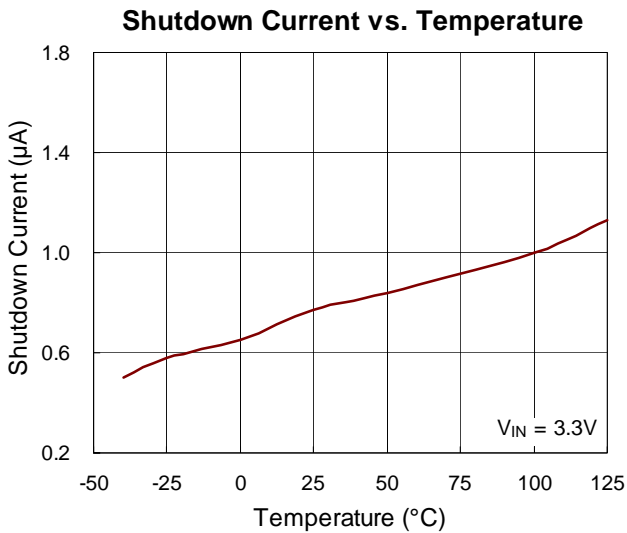
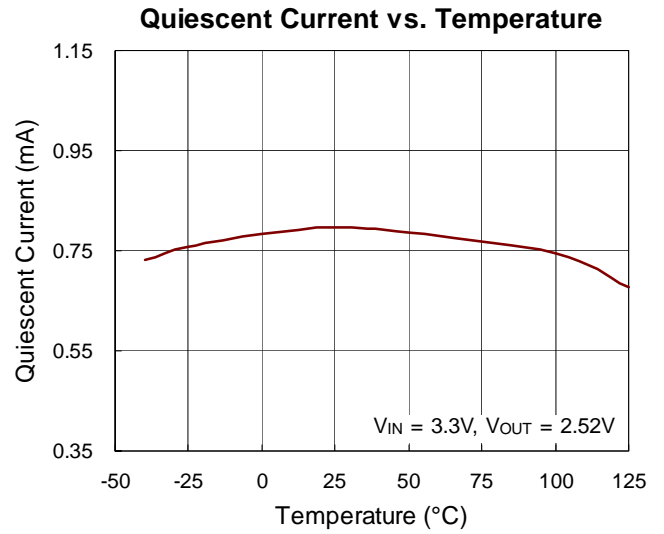
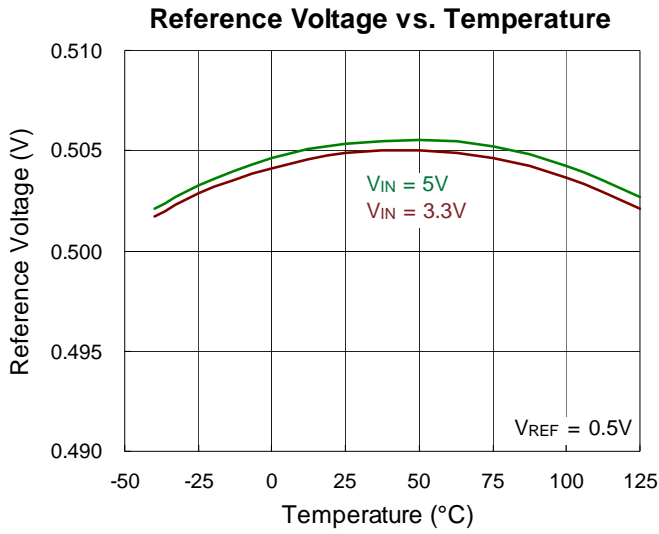
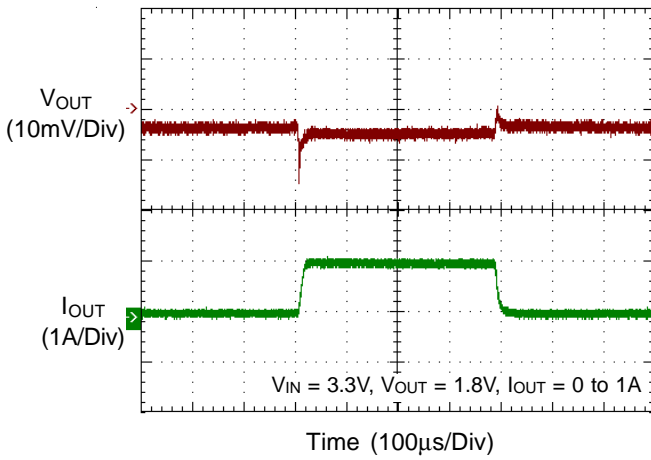

Figure 1. Adjustable Voltage Regulator

Typical Operating Characteristics



Load Transient Response



Line Transient Response

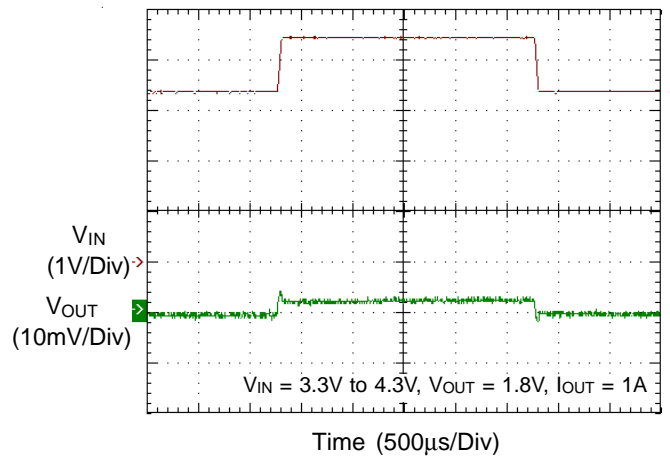

Power On from EN

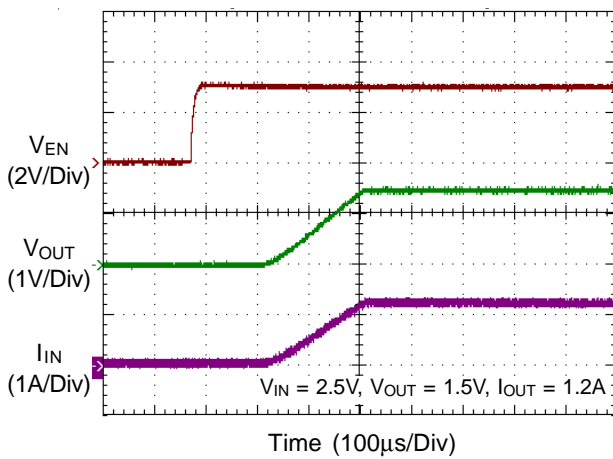

Power Off from EN

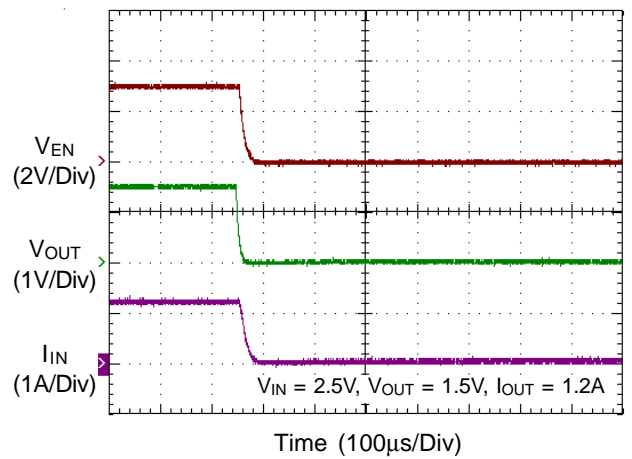

VOUT Start Up with EN

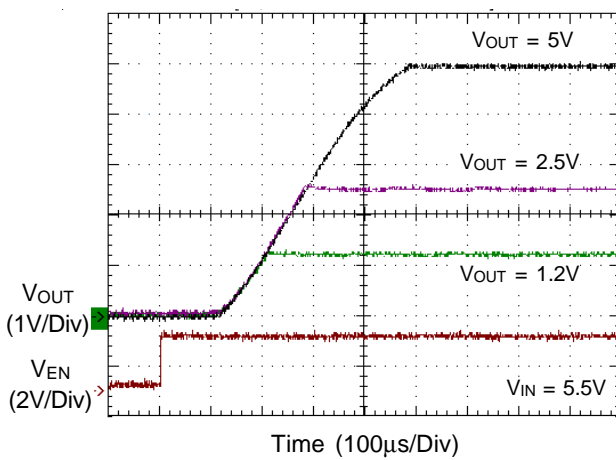

PSRR vs. Frequency

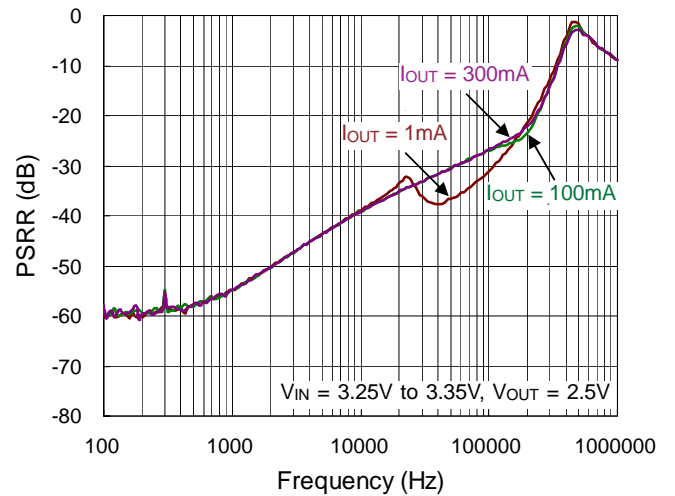

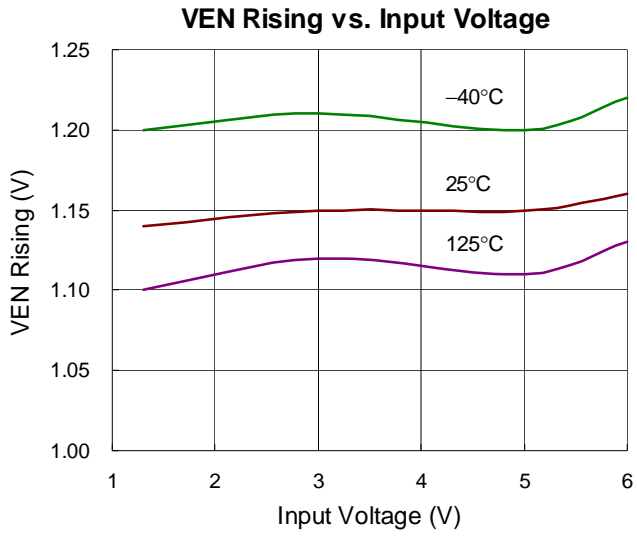

Application Information

The RT2518 is a low voltage, low dropout linear regulator with an external bias supply input capable of supporting an input voltage range from 1.4V to 6V.

Output Voltage Setting

The RT2518 output voltage is adjustable from 0.5V to 5.5V via the external resistive voltage divider. The voltage divider resistors can have values of up to 800kΩ because of the very high impedance and low bias current of the sense comparator. The output voltage is set according to the following equation :

$$V_{OUT} = V_{ADJ} \times \left(1 + \frac{R1}{R2} \right)$$

where V_{ADJ} is the reference voltage with a typical value of 0.5V.

Chip Enable Operation

The RT2518 goes into sleep mode when the EN pin is in a logic low condition. In this condition, the pass transistor, error amplifier, and band gap are all turned off, reducing the supply current to only 10μA (max.). The EN pin can be directly tied to VIN to keep the part on.

Current Limit

The RT2518 contains an independent current limit circuitry, which controls the pass transistor's gate voltage, limiting the output current to 1.6A (typ.).

C_{IN} and C_{OUT} Selection

Like any low dropout regulator, the external capacitors of the RT2518 must be carefully selected for regulator stability and performance. Using a capacitor of at least 10μF is suitable. The input capacitor must be located at a distance of no more than 0.5 inch from the input pin of the IC. Any good quality ceramic capacitor can be used. However, a capacitor with larger value and lower ESR (Equivalent Series Resistance) is recommended since it will provide better PSRR and line transient response.

The RT2518 is designed specifically to work with low ESR ceramic output capacitor for space saving and performance consideration. Using a ceramic capacitor with capacitance of at least 10μF and ESR larger than 1mΩ on the RT2518 output ensures stability. Nevertheless, the RT2518 can still work well with other types of output capacitors due to its wide range of stable ESR. Figure 2 shows the allowable ESR range as a function of load current for various output capacitance. Output capacitors with larger capacitance can reduce noise and improve load transient response, stability, and PSRR. The output capacitor should be located at a distance of no more than 0.5 inch from the output pin of the RT2518.

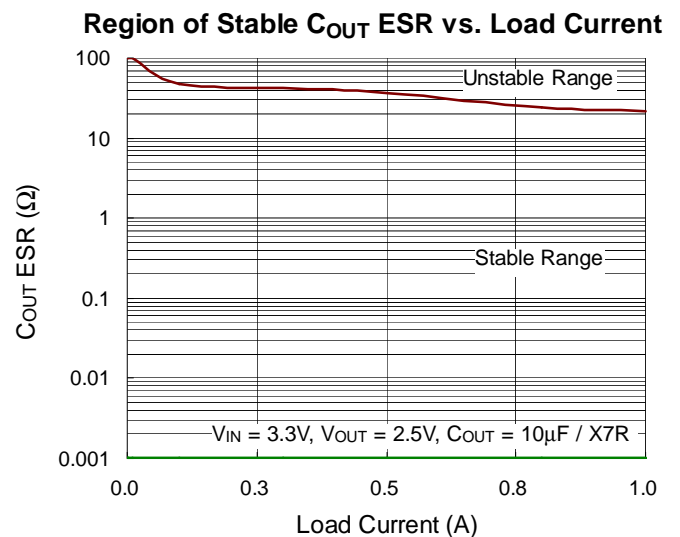

Figure 2

Thermal Considerations

Thermal protection limits power dissipation in the RT2518. When the operation junction temperature exceeds 160°C, the OTP circuit starts the thermal shutdown function and turns the pass element off. The pass element turns on again after the junction temperature cools by 30°C.

The RT2518 output voltage will be closed to zero when output short circuit occurs as shown in Figure 3. It can reduce the IC temperature and provides maximum safety to end users when output short circuit occurs.

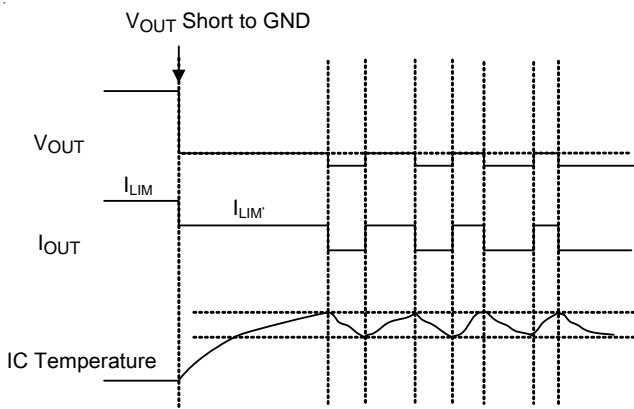

Figure 3. Short-Circuit Protection when Output Short-Circuit Occurs

For continuous operation, do not exceed absolute maximum junction temperature. The maximum power dissipation depends on the thermal resistance of the IC package, PCB layout, rate of surrounding airflow, and difference between junction and ambient temperature. The maximum power dissipation can be calculated by the following formula :

$$P_{D(MAX)} = (T_{J(MAX)} - T_A) / \theta_{JA}$$

where $T_{J(MAX)}$ is the maximum junction temperature, T_A is the ambient temperature, and θ_{JA} is the junction to ambient thermal resistance.

For recommended operating condition specifications, the maximum junction temperature is 125°C. The junction to ambient thermal resistance, θ_{JA} , is layout dependent. For WDFN-8L 3x3 package, the thermal resistance, θ_{JA} , is 49°C/W on a standard JEDEC 51-7 four-layer thermal test board. The maximum power dissipation at $T_A = 25^\circ\text{C}$ can be calculated by the following formula :

$$P_{D(MAX)} = (125^\circ\text{C} - 25^\circ\text{C}) / (49^\circ\text{C/W}) = 2.08\text{W for WDFN-8L 3x3 package}$$

The maximum power dissipation depends on the operating ambient temperature for fixed $T_{J(MAX)}$ and thermal resistance, θ_{JA} . The derating curve in Figure 4 allows the designer to see the effect of rising ambient temperature on the maximum power dissipation.

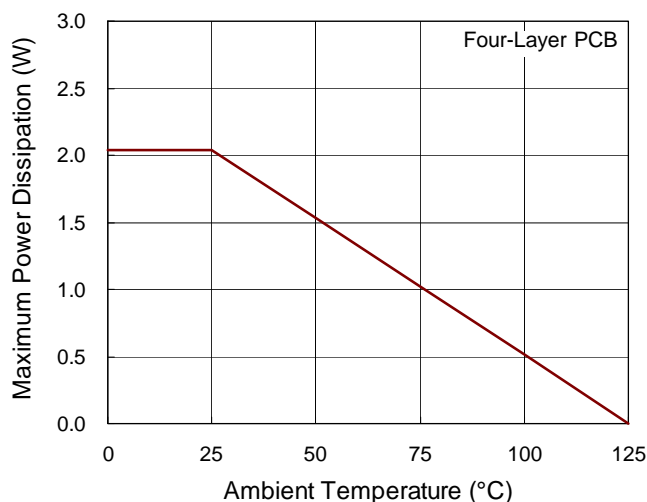

Figure 4. Derating Curve of Maximum Power Dissipation

IR Reflow Profile for Moisture Sensitivity Test (J-STD-020D) :

Reflow Condition (260°C) for Pb-free/ Green package

	IR*2
Average ramp-up rate (include 200°C to Peak)	Max 3°C/second
Preheat temperature 175(±25) °C	60 to 120 seconds
Temperature maintained above 217°C	60 to 150 seconds
Time within 5°C of actual peak temperature	30 seconds / min.
Peak temperature (minimum)	260 +2/-2°C
Ramp-down rate	6°C/second max.
Time 25°C to peak temperature	8 minutes max.

Infrared Reflow Profile

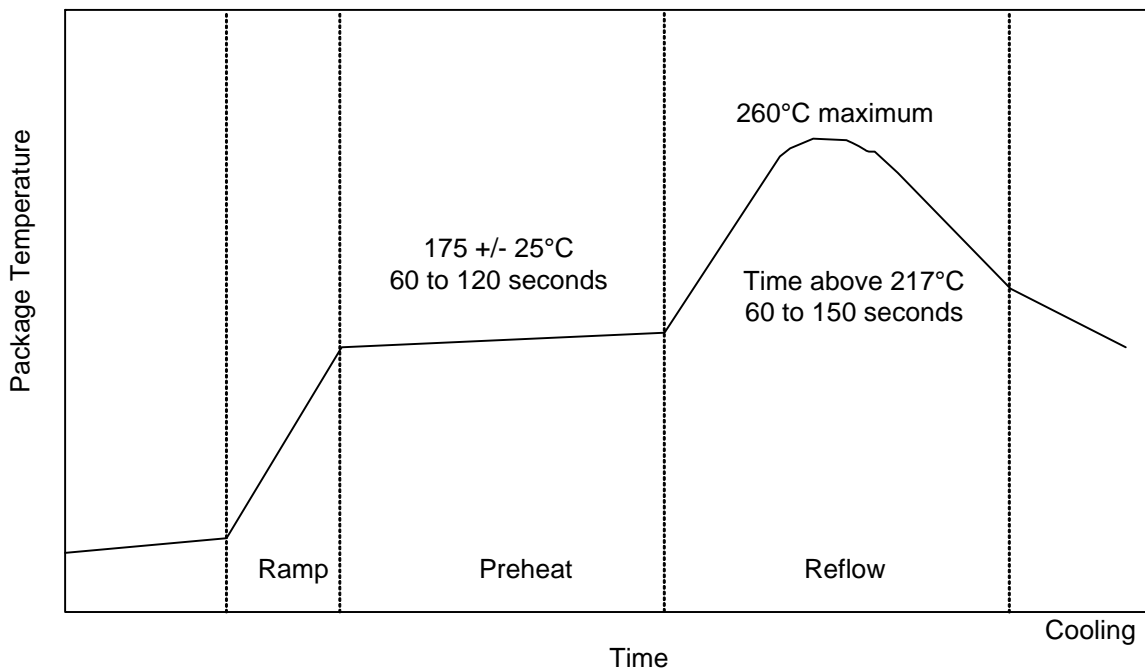

Outline Dimension

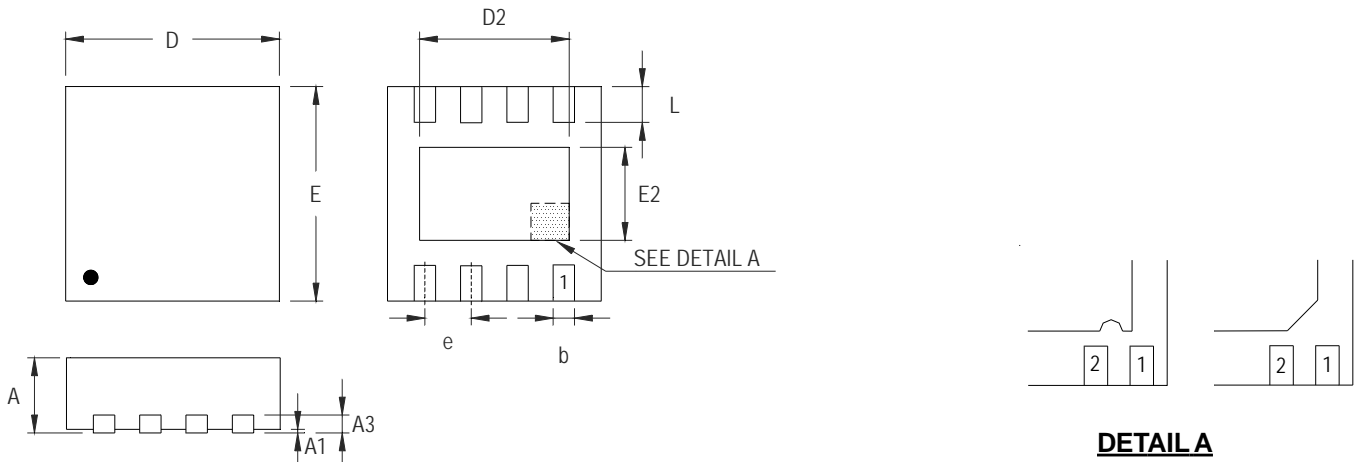

DETAIL A

Pin #1 ID and Tie Bar Mark Options

Note : The configuration of the Pin #1 identifier is optional, but must be located within the zone indicated.

Symbol	Dimensions In Millimeters		Dimensions In Inches	
	Min	Max	Min	Max
A	0.700	0.800	0.028	0.031
A1	0.000	0.050	0.000	0.002
A3	0.175	0.250	0.007	0.010
b	0.200	0.300	0.008	0.012
D	2.950	3.050	0.116	0.120
D2	2.100	2.350	0.083	0.093
E	2.950	3.050	0.116	0.120
E2	1.350	1.600	0.053	0.063
e	0.650		0.026	
L	0.425	0.525	0.017	0.021

W-Type 8L DFN 3x3 Package

Richtek Technology Corporation

14F, No. 8, Tai Yuen 1st Street, Chupei City
 Hsinchu, Taiwan, R.O.C.
 Tel: (8863)5526789

Richtek products are sold by description only. Customers should obtain the latest relevant information and data sheets before placing orders and should verify that such information is current and complete. Richtek cannot assume responsibility for use of any circuitry other than circuitry entirely embodied in a Richtek product. Information furnished by Richtek is believed to be accurate and reliable. However, no responsibility is assumed by Richtek or its subsidiaries for its use; nor for any infringements of patents or other rights of third parties which may result from its use. No license is granted by implication or otherwise under any patent or patent rights of Richtek or its subsidiaries.