

CL2 Unipolar Current Regulator 5-20mA Temperature Compensated

May 2021

Features

- Limits regulated current
- 5mA, 10mA, 15mA, 20mA versions
- Enable pin
- Rejects 50Hz / 60Hz ripple
- 250V maximum operating voltage
- Zero external components
- Can be paralleled for high current

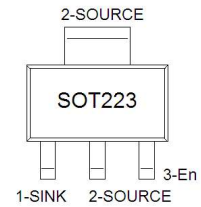
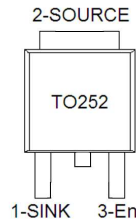

Description

The CL2 product family are temperature compensated unipolar current regulator with an enable pin available in 5mA to 20mA versions. It is designed to be used under a wide range of voltages, from 6V to 200V DC. The CL2 is primarily intended as a current limiting LED driver for serial LED applications in industrial lamp indicators, signage, accent and automotive lightning. Other applications include constant current source and sink. The CL2 temperature coefficient is optimized from -40°C to 125°C. The CL2 will source or sink constant current. The CL2 will likely require a heat sink connected to the Source (pin 2).

Absolute Maximum Ratings¹

Maximum operating voltage ²	250V DC
Maximum Enable voltage	10V DC
Operating free air temperature range	-40°C to 85°C
Storage Temperature	-40°C to 85°C
ESD tolerance, human body model	500V

Note 1: Stresses beyond “Absolute Maximum Ratings” may cause permanent damage to the device. These are stress ratings only, and functional operation of the device at these or beyond those conditions indicated under “Recommended Operating Conditions” is not implied. Exposure to absolute-maximum-rated conditions for extended period may impact device reliability.

Note 2: All voltages are with respect to Source

Recommended Operating Conditions

	Min	Max	Unit
Operating Voltage	6	200	V DC
Operating free air temperature	-40	85	°C
Operating chip temperature	-40	135	°C
V _{Enable}	0	8	V DC

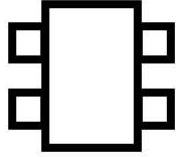

CL2 Unipolar Current Regulator 5-20mA Temperature Compensated

May 2021

Thermal Characteristics³

Ambient Temperature (25°C) unless otherwise specified

Parameter	Min	Typ	Max	Unit
SOT223 thermal resistance minimum copper layout		160		°C/Watt
SOT223 thermal resistance (0.60inch x 0.50inch)		88		°C/Watt
SOT223 thermal resistance (1.0inch x 1.0inch)		67		°C/Watt
TO252 thermal resistance minimum copper layout		110		°C/Watt
TO252 thermal resistance (0.60inch x 0.50inch)		75		°C/Watt
TO252 thermal resistance (1.0inch x 1.0inch)		50		°C/Watt

Note 3: Footprint copper layout size based on Package Heating Test Board (page 12)

Terminal Definition

Terminal Name	Pin No.	Type	Description
Sink	1	HV Input	Sinks the load current.
Source	2	VH Input	Usually Ground. Sources the load current.
Enable	3	Input	Enables current flow between Sink and Source.

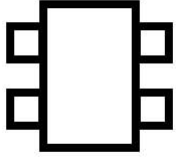

CL2 Unipolar Current Regulator 5-20mA Temperature Compensated

May 2021

Functional Block Diagram

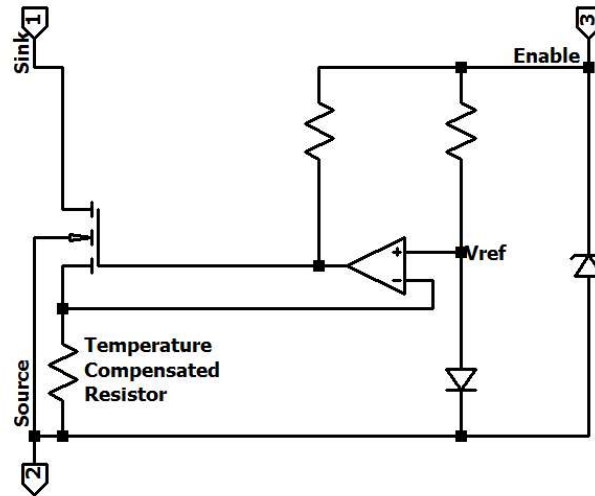

Concept of Operation

This chip is powered by applying a voltage difference between Sink and Source terminal. As the Enable voltage rises, the N-Channel MOSFET begins to conduct current between Sink and Source terminals. The temperature compensated source resistor senses this current and provides this feedback voltage to the non-inverting input of the operational amplifier. The operational amplifier compares the feedback voltage with the reference voltage provided by a p-n junction. The operational amplifier drives the gate of the N-channel MOSFET such that the feedback voltage and the reference voltage remain equal.

p-n junctions exhibit a negative temperature coefficient of approximately $-2\text{mV}/^\circ\text{C}$. The Source resistor is temperature compensated to match the temperature coefficient of the p-n junction. In this way, the regulated current flowing between Sink and Source will be (to a first order) independent of the chip junction temperature.

The power dissipated by the chip is given simply as $I_{lim} * (V_{Sink} - V_{Source})$. The chip will likely require a heat sink mechanically connected to the Source terminal (pin 2).

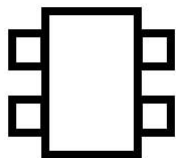

CL2 Unipolar Current Regulator 5-20mA Temperature Compensated

May 2021

Electrical Characteristics

$V_{\text{Sink}} - V_{\text{Source}} = 20\text{V}$, Temp = 25°C unless otherwise specified

20mA nominal device

Parameter	Min	Typ	Max	Unit
Regulated Current (I_{lim}) at 25°C	17.1	20.0	22.9	mA
Regulated Current (I_{lim}) at -40°C		18		mA
Regulated Current (I_{lim}) at +85°C		20.4		mA
Operating voltage for 90% regulated current	2.0	3.0	4.0	V
Absolute Temperature Coefficient		24		$\mu\text{A} / ^\circ\text{C}$
Voltage Coefficient 10V to 200V (pulse 10mSec)		0.4	0.6	mA / 100V
V_{Enable} fo 90% regulated current	2.0	3.1	4.0	V
V_{Enable} current ($V_{\text{Enable}} = 5\text{V}$, 25°C)		18	30	μA
V_{Enable} current ($V_{\text{Enable}} = 8\text{V}$, 85°C)		65		μA
Stabilization Time to 10% of final value		2.0		μSec
Transient response to 10% to 90%		300		nSec

15mA nominal device

Parameter	Min	Typ	Max	Unit
Regulated Current (I_{lim}) at 25°C	12.8	15	17.2	mA
Regulated Current (I_{lim}) at -40°C		13.5		mA
Regulated Current (I_{lim}) at +85°C		15.3		mA
Operating voltage for 90% regulated current	2.0	3.0	4.0	V
Absolute Temperature Coefficient		18		$\mu\text{A} / ^\circ\text{C}$
Voltage Coefficient 10V to 200V (pulse 10mSec)		0.3	0.5	mA / 100V
V_{Enable} fo 90% regulated current	2.0	3.1	4.0	V
V_{Enable} current ($V_{\text{Enable}} = 5\text{V}$, 25°C)		18	30	μA
V_{Enable} current ($V_{\text{Enable}} = 8\text{V}$, 85°C)		65		μA
Stabilization Time to 10% of final value		2.0		μSec
Transient response to 10% to 90%		300		nSec

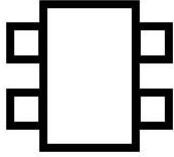

CL2 Unipolar Current Regulator 5-20mA Temperature Compensated

May 2021

Electrical Characteristics (cont.)

$V_{\text{Sink}} - V_{\text{Source}} = 20\text{V}$, Temp = 25°C unless otherwise specified

10mA nominal device

Parameter	Min	Typ	Max	Unit
Regulated Current (I_{lim}) at 25°C	8.5	10.0	11.5	mA
Regulated Current (I_{lim}) at -40°C		9		mA
Regulated Current (I_{lim}) at +85°C		10.2		mA
Operating voltage for 90% regulated current	2.0	3.0	4.0	V
Absolute Temperature Coefficient		12		$\mu\text{A} / ^\circ\text{C}$
Voltage Coefficient 10V to 200V (pulse 10mSec)		0.2	0.4	mA / 100V
V_{Enable} fo 90% regulated current	2.0	3.1	4.0	V
V_{Enable} current ($V_{\text{Enable}} = 5\text{V}$, 25°C)		18	30	μA
V_{Enable} current ($V_{\text{Enable}} = 8\text{V}$, 85°C)		65		μA
Stabilization Time to 10% of final value		2.0		μSec
Transient response to 10% to 90%		300		nSec

5mA nominal device

Parameter	Min	Typ	Max	Unit
Regulated Current (I_{lim}) at 25°C	4.2	5.0	5.8	mA
Regulated Current (I_{lim}) at -40°C		4.5		mA
Regulated Current (I_{lim}) at +85°C		5.1		mA
Operating voltage for 90% regulated current	2.0	3.0	4.0	V
Absolute Temperature Coefficient		6		$\mu\text{A} / ^\circ\text{C}$
Voltage Coefficient 10V to 200V (pulse 10mSec)		0.1	0.3	mA / 100V
V_{Enable} fo 90% regulated current	2.0	3.1	4.0	V
V_{Enable} current ($V_{\text{Enable}} = 5\text{V}$, 25°C)		18	30	μA
V_{Enable} current ($V_{\text{Enable}} = 8\text{V}$, 85°C)		65		μA
Stabilization Time to 10% of final value		2.0		μSec
Transient response to 10% to 90%		300		nSec

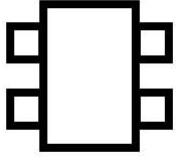

Characteristic Curves (25°C, 20mA version)

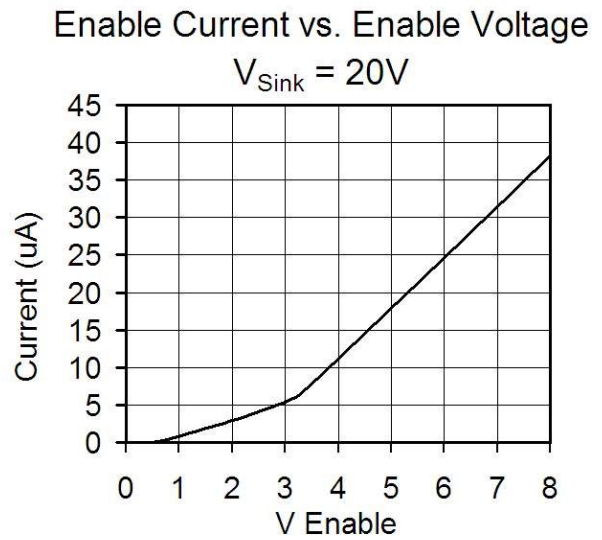
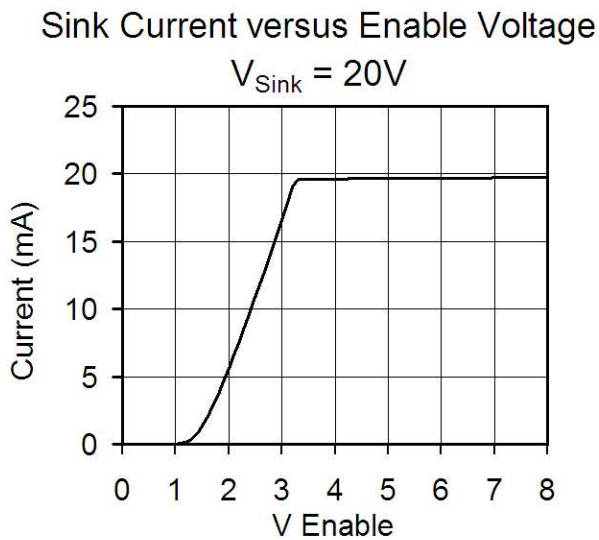
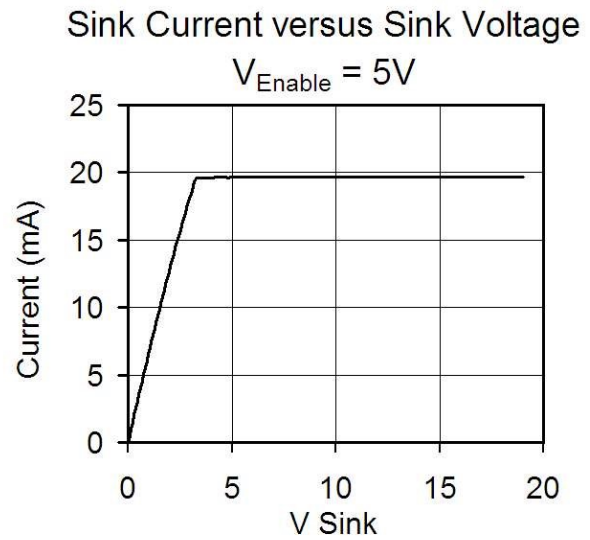
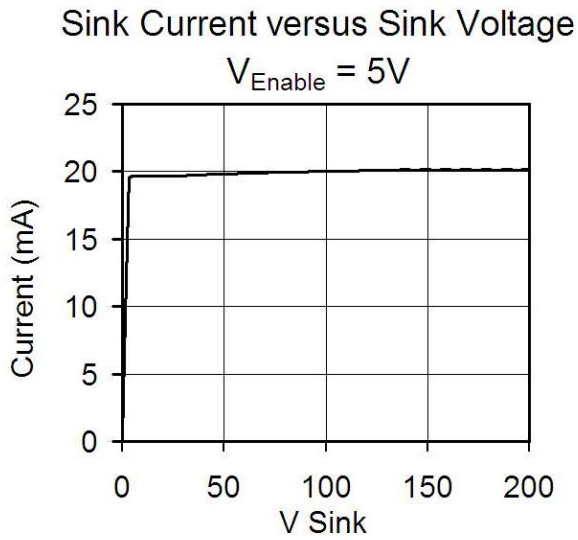

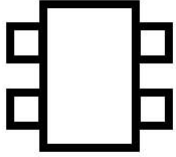

CL2 Unipolar Current Regulator 5-20mA Temperature Compensated

May 2021

Characteristics curves (25°C, 20mA version)

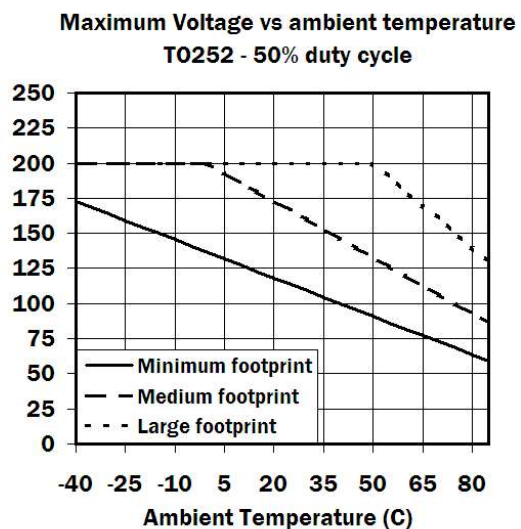
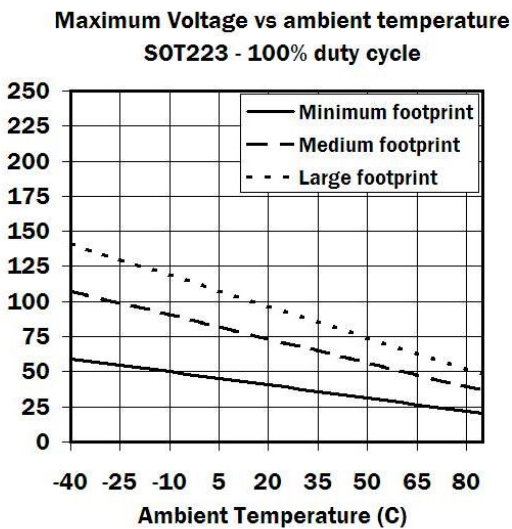
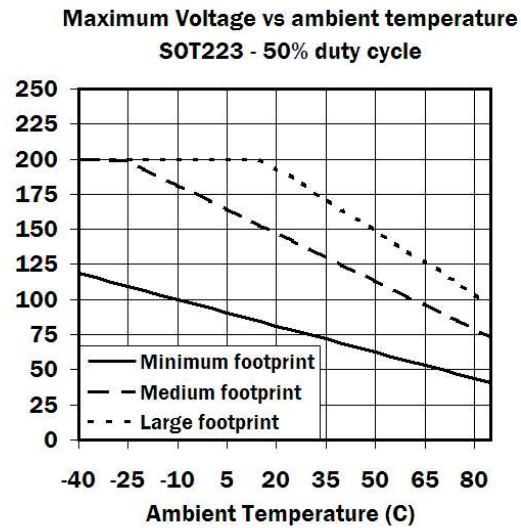
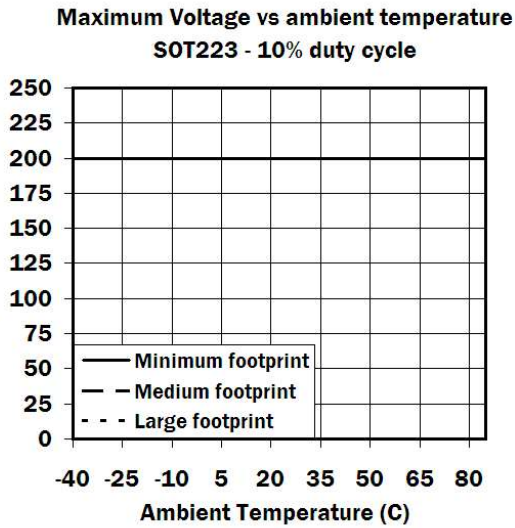

Note 4: Footprint size based on Package Heating Test Board (page 12)

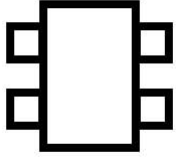

CL2 Unipolar Current Regulator 5-20mA Temperature Compensated

May 2021

Characteristics curves (25°C, 20mA version)

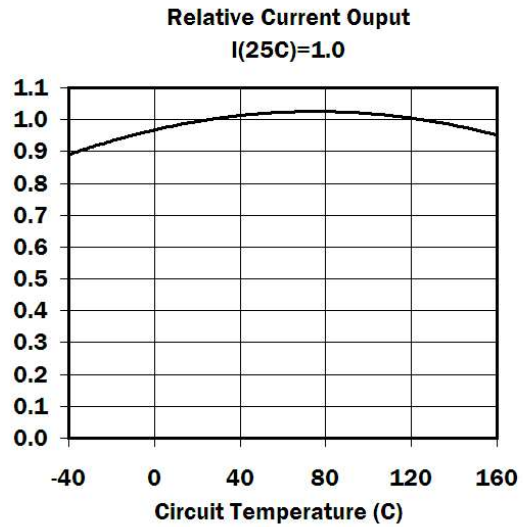
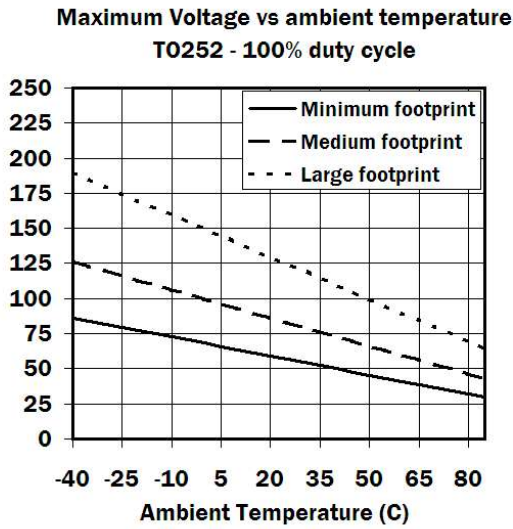

Note 5: Footprint size based on Package Heating Test Board (page 12)

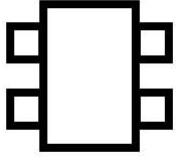

CL2 Unipolar Current Regulator 5-20mA Temperature Compensated

May 2021

Characteristics curves (25°C, 20mA version)

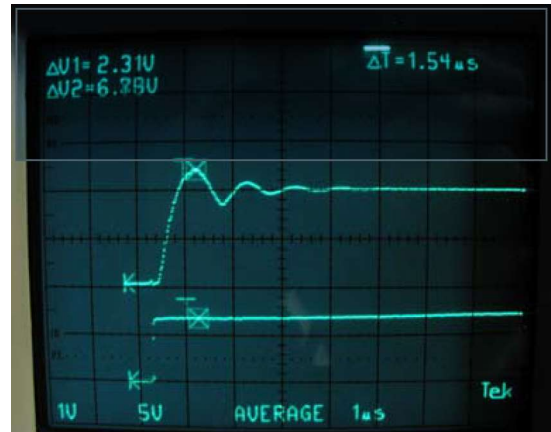
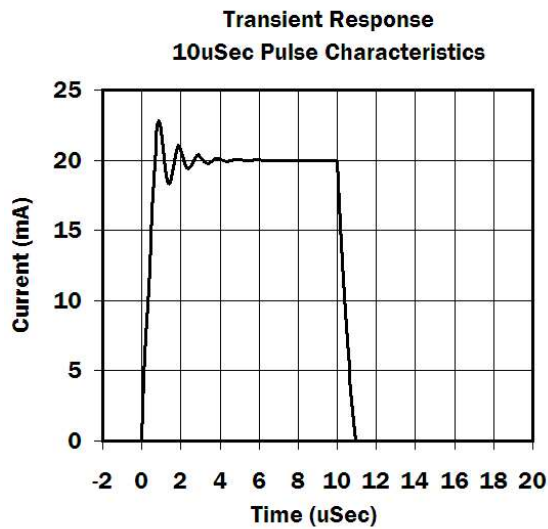
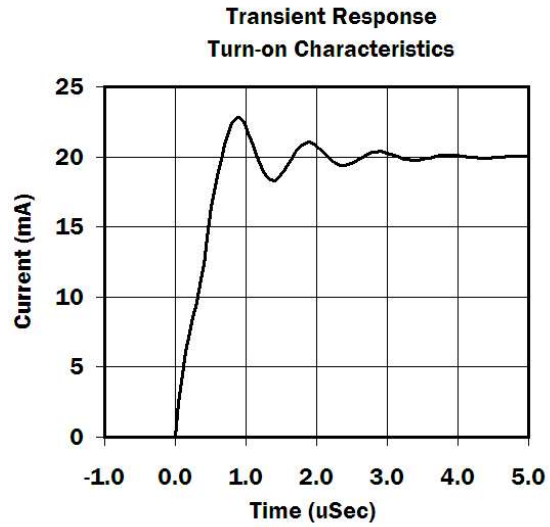
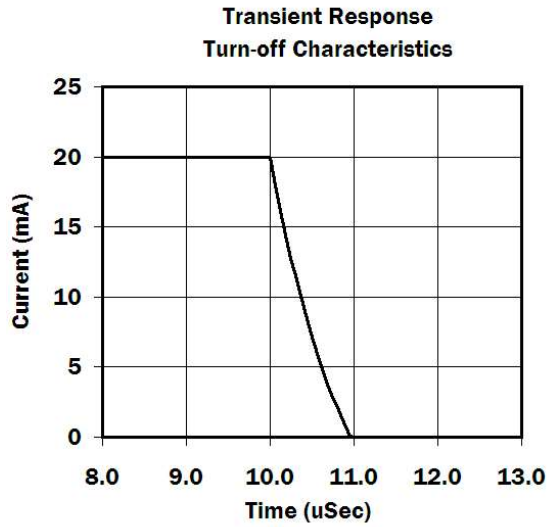

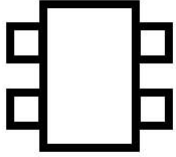

CL2 Unipolar Current Regulator 5-20mA Temperature Compensated

May 2021

Typical Application Circuit

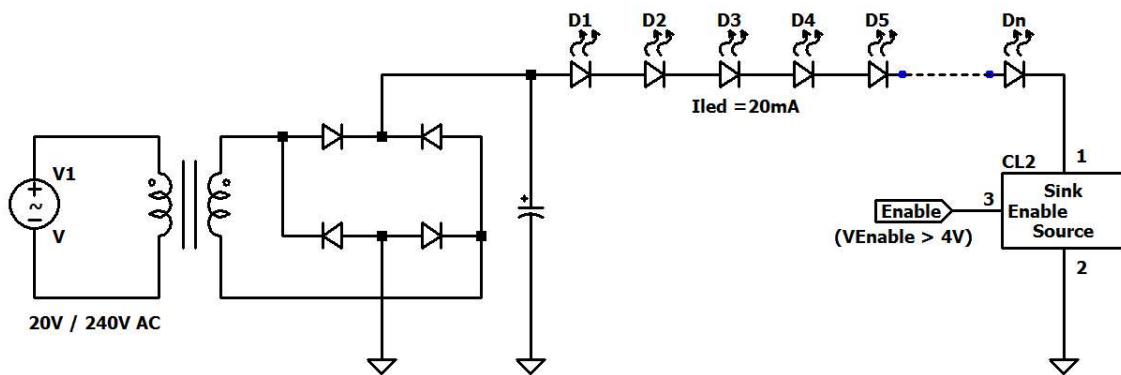

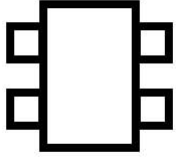

CL2 Unipolar Current Regulator 5-20mA Temperature Compensated

May 2021

Package Dimensions

3-Lead TO-252 (DPAK)

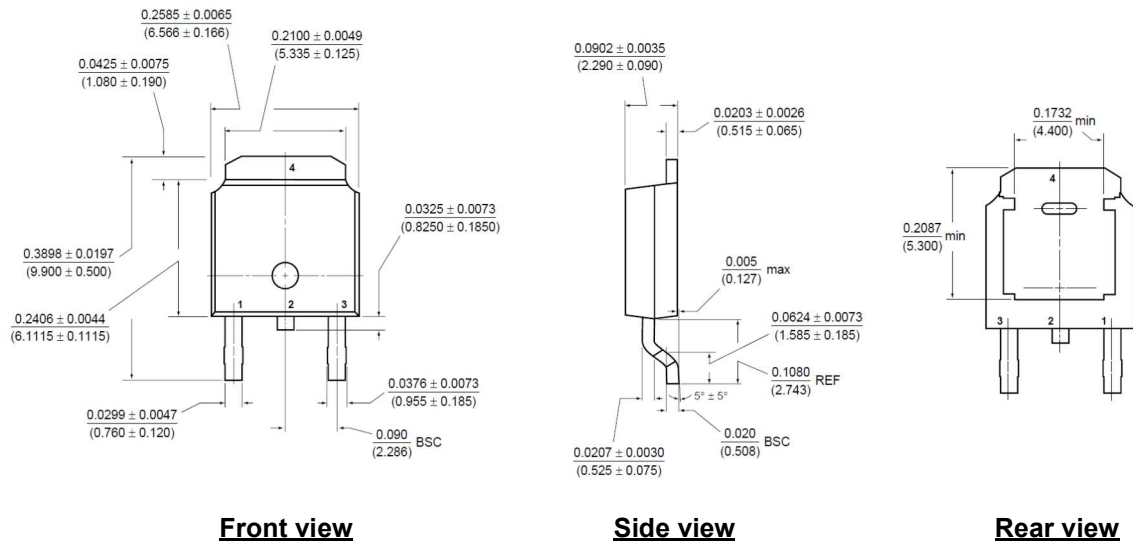

3-Lead SOT-223

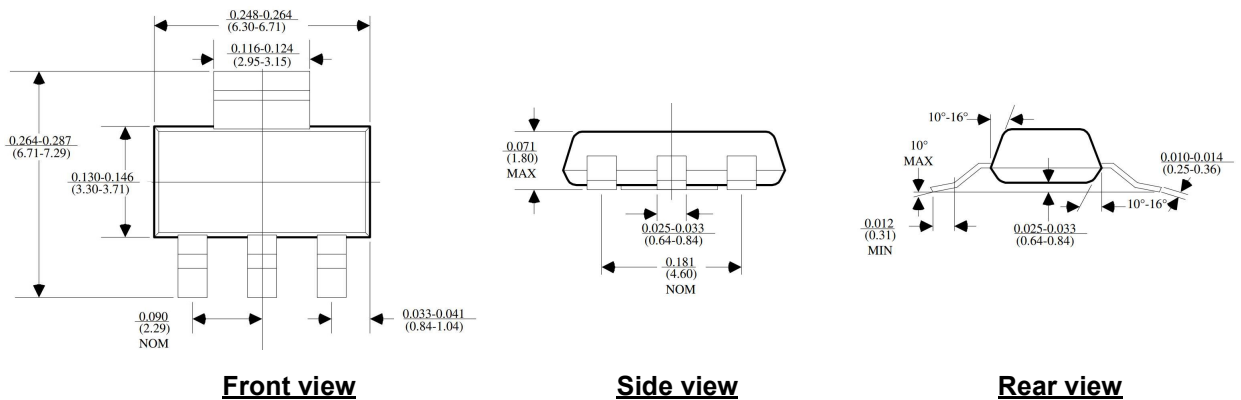

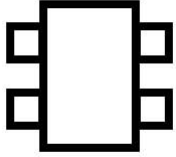

CL2 Unipolar Current Regulator 5-20mA Temperature Compensated

May 2021

Thermal properties test boards:

(Schematics not to scale)

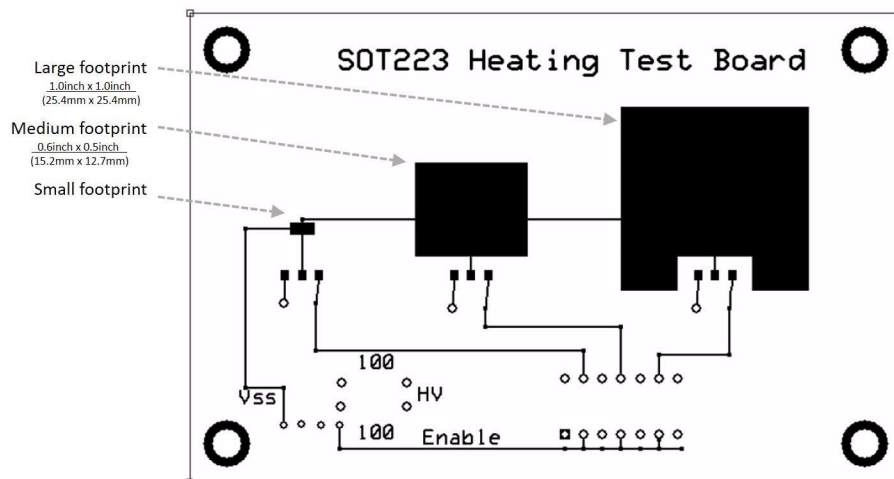
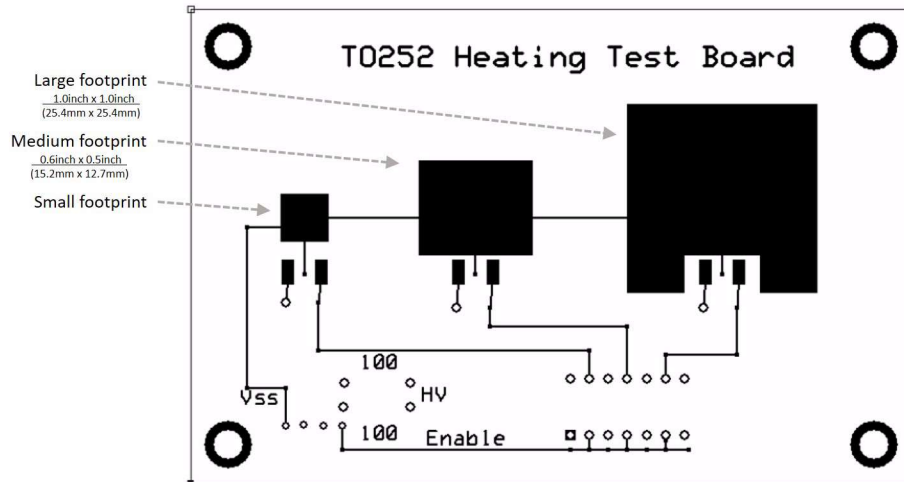

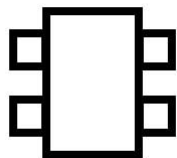

CL2
Unipolar Current Regulator
5-20mA Temperature Compensated
May 2021

Product Identification Codes

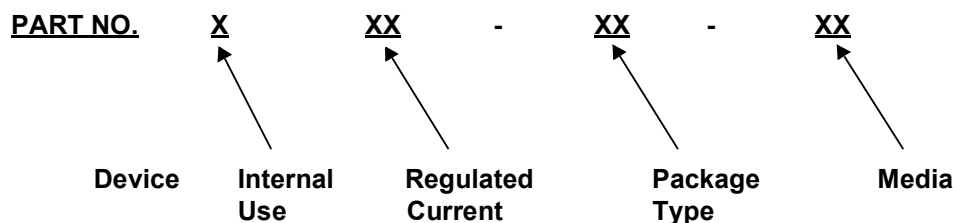

Device: CL2 = Temperature Compensated Unipolar Current Regulator

Internal use: A = Internal Use
 B
 C

Regulated Current: 5 = 5mA
 10 = 10mA
 15 = 15mA
 20 = 20mA

Package: M = SOT-223
 ST = TO-252 (DPAK)

Media Type: B = Bulk Samples
 T = Tubes
 TR = Tape & Reel