

# Miniature 6-axis force torque sensor MMS101 Data Sheet

## DESCRIPTION



This is a 6-axis force torque sensor which has 3-axis force and 3-axis moment. It has a hybrid structure of a MEMS chip and a metal structure, realizing 6-axis detection. This product has AFE ICs built in its module and produces digital output (SPI). Correction coefficients used for matrix operation (other axis interference components are removed) are stored in memories inside the AFE ICs. Since they can be read out immediately before the measurement start, users do not have to control the sensor and the correction coefficients. Additionally, the LDO built in the module reduces noises. This product is extremely small and light, suitable for fingertips of robot hands.

## FEATURES

- Very small :  $\Phi 9.6(W) \times 9.0(H)$  mm
- Light weight : 3 g
- High load capacity  $F_x, F_y, F_z : 200N / M_x, M_y, M_z : 1.8N \cdot m$
- Load rating  $F_x, F_y, F_z : 40N / M_x, M_y, M_z : 0.4N \cdot m$

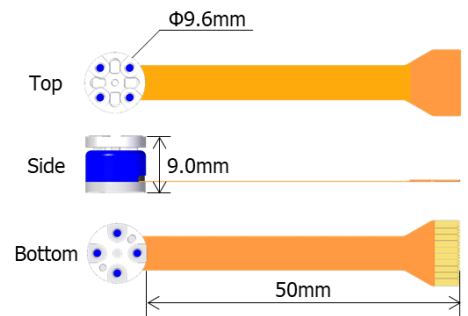
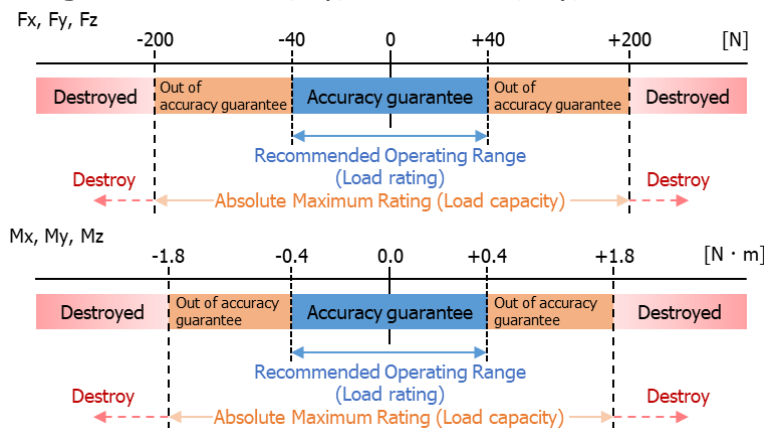

Fig. 1 Product appearance

- Noise reduction by built-in LDO  $F_x, F_y : 0.04N \text{ RMS} / F_z : 0.06N \text{ RMS}$   
 $M_x, M_y : 0.0004N \cdot m \text{ RMS} / M_z : 0.0008N \cdot m \text{ RMS}$
- Digital output of 6-axis data by built-in sequencer (SPI)
- RoHS compliant
- Halogen-contained

## MODEL NUMBER

- MMS101BXXA

\*Before installing and using this product, please carefully read "[PRECAUTIONS FOR SENSOR INSTALLATION](#)" and "[PRECAUTIONS FOR SENSOR HANDLE](#)" in this document. Otherwise, incorrect installation may cause damage to this product.

The contents of this document are subject to change without notice.

## INDEX

DESCRIPTION .....	1
FEATURES .....	1
MODEL NUMBER .....	1
BLOCK DIAGRAM.....	3
PIN CONFIGURATION.....	4
TERMINAL EXPLANATIONS .....	5
ABSOLUTE MAXIMUM RATINGS .....	6
RECOMMENDED OPERATING CONDITIONS .....	6
Power-on sequence .....	7
FORCE TORQUE SENSOR CHARACTERISTICS .....	8
Definition of Force Torque Sensor Characteristics .....	9
ELECTRICAL CHARACTERISTICS .....	12
Analog Characteristics.....	12
Digital I/O Characteristics .....	12
FUNCTION .....	13
Operation Description .....	13
Read of matrix operation correction coefficients .....	14
Measurement start instruction .....	15
ADC data acquisition.....	16
Matrix operation .....	17
Measurement finish instruction .....	21
Update of temperature sensor value for offset temperature correction .....	22
Measurement timing chart .....	23
COMMAND CODE .....	25
STATE TRANSITION DIAGRAM.....	26
SERIAL INTERFACE .....	27
SPI format .....	27
SPI AC Characteristics.....	29
TYPICAL APPLICATION CIRCUIT .....	30
DIMENSIONS .....	31
Sensor coordination systems .....	32
Example of sensor attachment .....	33
PRECAUTIONS FOR SENSOR INSTALLATION.....	35
Installation screw .....	35
Positioning hole.....	36
Recommended tightening method of sensor installation screw .....	36
Sensor contact surface.....	37
PRECAUTIONS FOR SENSOR HANDLE.....	38
Handling of sensor FPC.....	38
OPTION .....	39
Evaluation Kit.....	39
Conversion Board .....	42
NOTES.....	43
NOTES.....	43
ATTENTION .....	45
ADDITIONAL NOTES.....	45

**BLOCK DIAGRAM**

This product has six AFEs corresponding to each axis. Please switch CSB pin voltage level to access each AFE for operation.

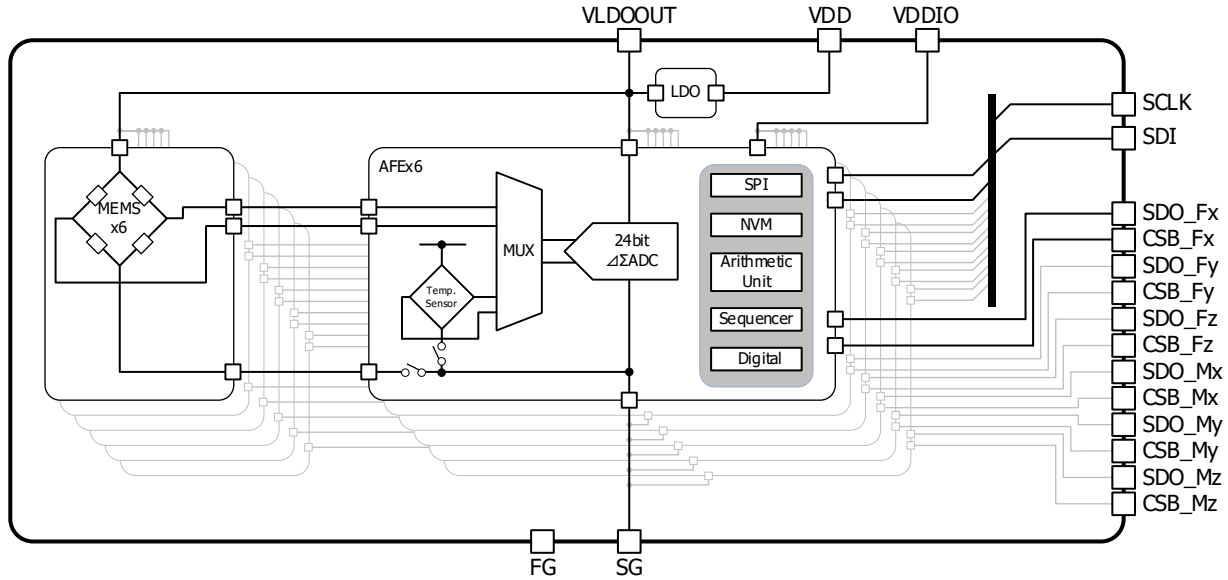

Fig. 2 Block Diagram

PIN CONFIGURATION

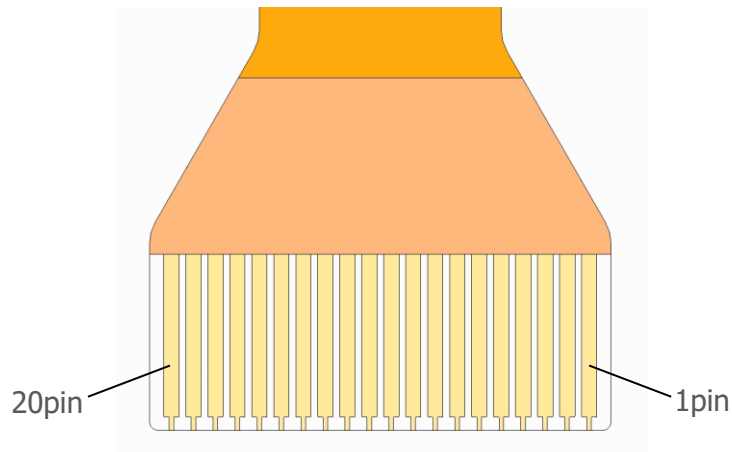
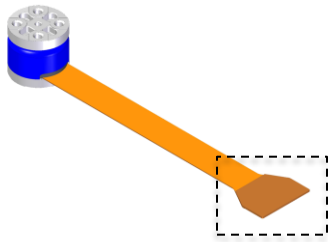

Fig. 3 Pin configuration

\*The terminal are located on the back of the FPC.  
The above finger is a perspective view.

## TERMINAL EXPLANATIONS

Table 1 Pin table

No.	Pin Name	Type	Function
1	FG	-	Frame ground
2	FG	-	Frame ground
3	CSB_Fz	I	AFE3(Fz) Chip select for SPI communication (negative logic)
4	SDO_Fz	O	AFE3(Fz) Serial Data Output for SPI communication
5	CSB_Mz	I	AFE6(Mz) Chip select for SPI communication (negative logic)
6	SDO_Mz	O	AFE6(Mz) Serial Data Output for SPI communication
7	CSB_Mx	I	AFE4(Mx) Chip select for SPI communication (negative logic)
8	CSB_My	I	AFE5(My) Chip select for SPI communication (negative logic)
9	VDDIO	I	Digital I/O power supply
10	VLDOOUT	O	Built-in LDO output * Not-in-use during normal operation. However, it is recommended to connect a capacitor (10uF) near the sensor connection cable connector on your circuit board for noise reduction.
11	VDD	I	Analog power supply
12	SG	-	Signal ground
13	CSB_Fx	I	AFE1(Fx) Serial Data Output for SPI communication
14	SCLK	I	Serial clock for SPI communication
15	SDO_Fy	O	AFE2(Fy) Serial Data Output for SPI communication
16	SDI	I	Serial Data Input for SPI communication
17	SDO_My	O	AFE5(My) Serial Data Output for SPI communication
18	SDO_Fx	O	AFE1(Fx) Serial Data Output for SPI communication
19	SDO_Mx	O	AFE4(Mx) Serial Data Output for SPI communication
20	CSB_Fy	I	AFE2(Fy) Chip select for SPI communication (negative logic)

The contents of this document are subject to change without notice.

## ABSOLUTE MAXIMUM RATINGS

(unless otherwise specified, Ta = 25°C)

Item	Symbol	Min.	Max.	Unit
Load capacity	F <sub>MAX</sub>	-200	200	N
	M <sub>MAX</sub>	-1.8	1.8	N·m
Storage temperature range	T <sub>STG</sub>	-10	+60	°C
Analog supply voltage	VDD <sub>MAX</sub>	-0.3	+15	V
Digital I/O voltage	VDDIO <sub>MAX</sub>	-0.3	+4.0	V

## RECOMMENDED OPERATING CONDITIONS

(unless otherwise specified, Ta = 25°C)

Item	Symbol	Min.	Max.	Unit
Load rating	F <sub>OPR</sub>	-40	40	N
	M <sub>OPR</sub>	-0.4	0.4	N·m
Operating temperature range	T <sub>OPR</sub>	+5	+45	°C
Analog supply voltage	VDD <sub>OPR</sub>	+3.8	+14	V
Digital I/O voltage	VDDIO <sub>OPR</sub>	+1.14	+3.6	V

Power-on sequence

There is no specification for the power-on sequence of both VDD and VDDIO supplies. When the power is turned on, access the device at least 10msec after both VDD and VDDIO supplies have reached 90% of the applied voltage.

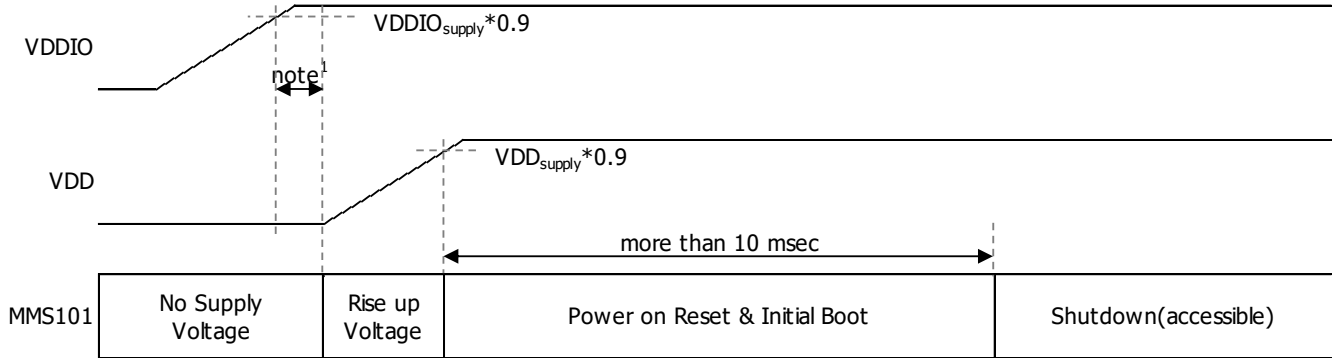

Fig. 4 Power-on sequence

note<sup>1</sup>: No time is specified from starting VDDIO to input VDD. There is no problem even if the power-on sequence of both VDD and VDDIO supplies is reversed.

## FORCE TORQUE SENSOR CHARACTERISTICS

(unless otherwise specified,  $T_a = 25^\circ\text{C}$ ,  $V_{DD} = 3.8$  to  $14$  V,  $V_{DDIO} = 1.14$  to  $3.6$  V)

Item		Symbol	Condition	Min.	Typ.	Max.	Unit.
Theoretical resolution	FxFyFz	$F_{RES}$	-	-	0.001	-	N
	MxMyMz	$M_{RES}$	-	-	0.00001	-	N·m
Effective resolution (note <sup>2</sup> )	FxFy	$F_{Eresxy}$	-	-	0.04	-	N RMS
	Fz	$F_{Eresz}$	-	-	0.06	-	N RMS
	MxMy	$M_{Eresxy}$	-	-	0.0004	-	N·m RMS
	Mz	$M_{Eresz}$	-	-	0.0008	-	N·m RMS
Linearity (note <sup>2</sup> )		$F_L$ $M_L$	FS=40N or 0.4N·m	-1.0	-	1.0	%FS
Hysteresis (note <sup>3</sup> )		$F_{Hys}$ $M_{Hys}$	FS=40N or 0.4N·m	-1.0	-	1.0	%FS
Accuracy (note <sup>2</sup> )		$F_{Acc}$ $M_{Acc}$	FS=40N or 0.4N·m	-5.0	-	5.0	%FS
Conversion time (note <sup>3</sup> )		$t_{con}$	-	-	781.25	-	usec
Latency (note <sup>3</sup> )		$t_{lat}$	Conversion time: Typ. Communication clock: 1MHz No delay in switching of AFE to access	-	-	2.0	msec

note<sup>2</sup>: The values in chart are the results of the measurement using our evaluation equipment and board.note<sup>3</sup>: Design assurance item



### Definition of Force Torque Sensor Characteristics

- Full Scale FS  
Full-scale FS is 40N or 0.4N·m from zero to the load rating for positive and negative.
- Theoretical resolution  
The value is equivalent to 1LSB of output data.
- Effective resolution  
Standard deviation of 500-point data acquired after measurement is started with no load and the output is stabled.
- Linearity  
Deviation from Reference line connecting the output between no load state and +40N (0.4N·m) applied state or -40 N (0.4N·m) applied state.

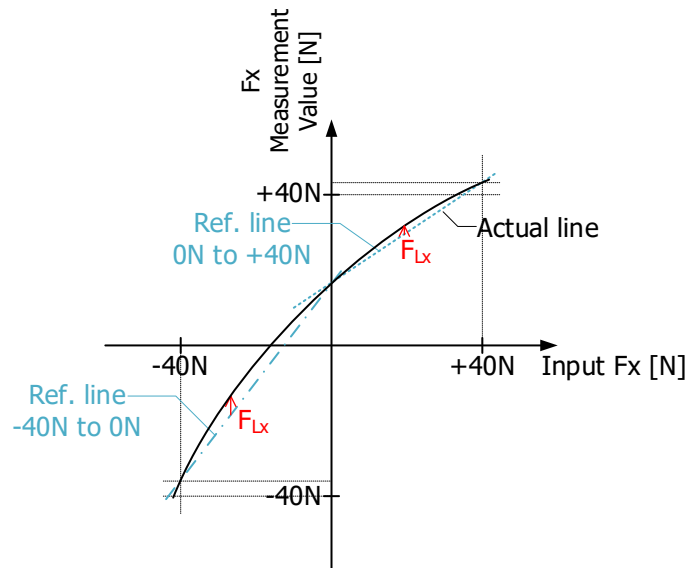

Fig. 5 Linearity (example: Fx)

- Hysteresis

Change amount from the origin after having applied the load ratings (+40N (0.4N·m) or -40N (-0.4N·m)).

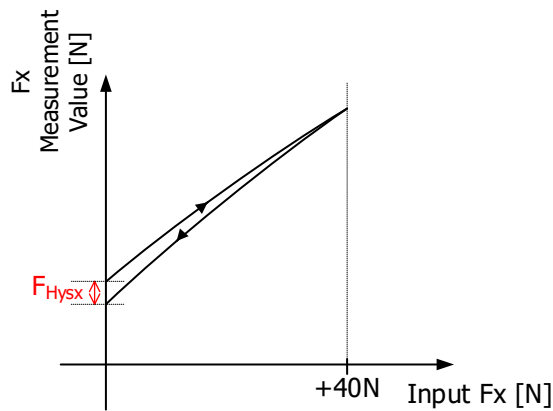

Fig. 6 Hysteresis (example: Fx)

- Accuracy

Deviation of the applied load and output when a load is applied to the main axis while the offset output in the unloaded state is canceled.

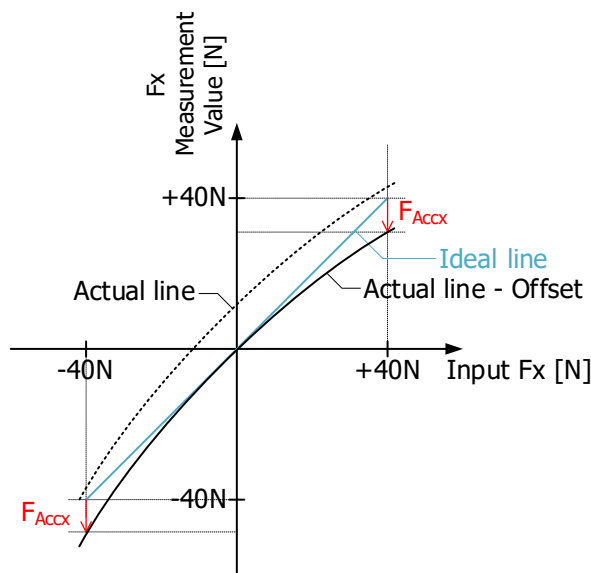

Fig. 7 Accuracy (example: Fx)

- Conversion time  
Update interval of ADC data output from each AFE
- Latency  
Delay time from the timing of output data measurement to the timing of matrix operation completion.

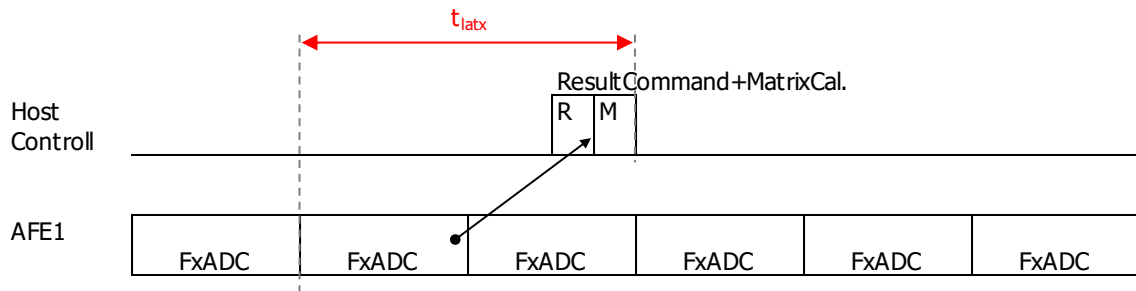

Fig. 8 Latency (example: Fx)

## ELECTRICAL CHARACTERISTICS

## Analog Characteristics

(unless otherwise specified, Ta = 25°C, VDD = 4.3 V, VDDIO = 3.3 V)

Item	Symbol	Condition	Min.	Typ.	Max.	Unit.
VDD Current consumption	I <sub>VDDact</sub>	Measure active	-	-	10	mA
VDDIO Current consumption	I <sub>VDDIOact</sub>	Measure active	-	-	20	uA

## Digital I/O Characteristics

(unless otherwise specified, Ta = 25°C, VDD = 3.8 to 14 V, VDDIO = 1.14 to 3.6 V)

Item	Symbol	Condition	Min.	Typ.	Max.	Unit
High level Input voltage	V <sub>IH</sub>	-	0.8 × VDDIO	-	VDDIO + 0.3	V
Low level Input voltage	V <sub>IL</sub>	-	-0.3	-	0.2 × VDDIO	V
Output voltage High level	V <sub>OH1</sub>	VDDIO ≥ 2.0V, I <sub>load</sub> = -3mA	VDDIO - 0.4	-	-	V
	V <sub>OH2</sub>	VDDIO < 2.0V, I <sub>load</sub> = -1mA	0.8 × VDDIO	-	-	V
Output voltage Low level	V <sub>OL1</sub>	VDDIO ≥ 2.0V, I <sub>load</sub> = 3mA	-	-	0.4	V
	V <sub>OL2</sub>	VDDIO < 2.0V, I <sub>load</sub> = 1mA	-	-	0.2 × VDDIO	V

**FUNCTION**

Operation Description

MMS101 can acquire data following the operation flow shown below.

Correction coefficients used in the matrix operation are stored in the memory (NVM: Non-Volatile Memory) built in each AFE. Reading out the correction coefficients before issuance of measurement start instruction allows the matrix operation after ADC data of each axis is acquired.

ADC data offset changes depending on ambient temperature. If needed, temperature sensor values used for offset correction arithmetic done in each AFE should be updated at any timing.

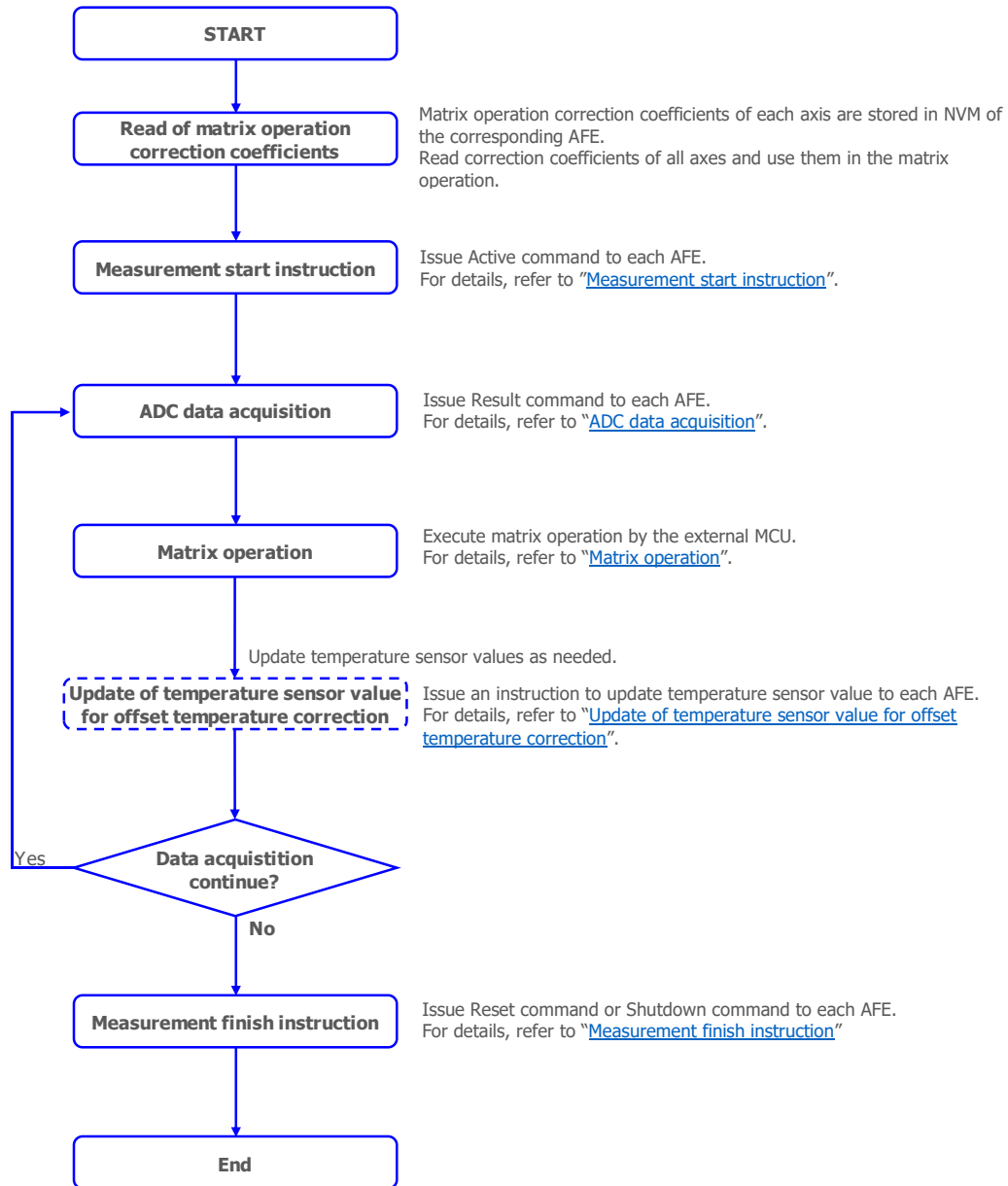

Fig. 9 Operation flow chart

Read of matrix operation correction coefficients

Matrix operation correction coefficients are stored in the memory (NVM: Non-Volatile Memory) built in each AFE. Please read the matrix operation correction coefficient 1 to 6 (3 bytes / 24 bits) shown in Table 3 from all AFEs. These coefficients can be read by executing NVM read command. To execute this command, AFEs must be in the Idle state. Therefore, Idle command must be issued and executed in advance. For command code and format, refer to "[COMMAND CODE](#)" and "[SPI format](#)".

Table 2 NVM map of matrix operation correction coefficients

NVM Addr.		Symbols in Matrix operation formula (note <sup>4</sup> )						
		AFE1	AFE2	AFE3	AFE4	AFE5	AFE6	
5Ah	MSB	Matrix operation correction coefficient 1	A1	B1	C1	D1	E1	F1
5Bh								
5Ch	LSB							
5Dh	MSB	Matrix operation correction coefficient 2	A2	B2	C2	D2	E2	F2
5Eh								
5Fh	LSB							
60h	MSB	Matrix operation correction coefficient 3	A3	B3	C3	D3	E3	F3
61h								
62h	LSB							
63h-6Bh	For Manufacturer							
6Ch	MSB	Matrix operation correction coefficient 4	A4	B4	C4	D4	E4	F4
6Dh								
6Eh	LSB							
6Fh	MSB	Matrix operation correction coefficient 5	A5	B5	C5	D5	E5	F5
70h								
71h	LSB							
72h	MSB	Matrix operation correction coefficient 6	A6	B6	C6	D6	E6	F6
73h								
74h	LSB							

note<sup>4</sup>: For details of matrix operation formula, refer to "[Matrix operation](#)".

Measurement start instruction

Each AFE starts AD conversion when receiving Active command. For command code and format, refer to “[COMMAND CODE](#)” and “[SPI format](#)”. Fig. 10 schematically shows an example of AD conversion start instruction issued to AFE1. This instruction must be issued to all AFEs because matrix operation uses ADC data of all axes.

ADC data is subject to offset temperature correction in each AFE. Approximately 7.5 msec is required to complete the first AD conversion because of temperature sensor measurement for offset temperature correction and waiting for filter stabilization. From the second AD conversion, the conversion is repeated at the interval of approximately 0.8 msec because neither the temperature sensor measurement nor waiting for filter stabilization is required.

Drift occurs in Fz (AFE3) immediately after the AD conversion start. In this case, it is recommended that data is acquired after waiting approximately 5 min for stabilization.

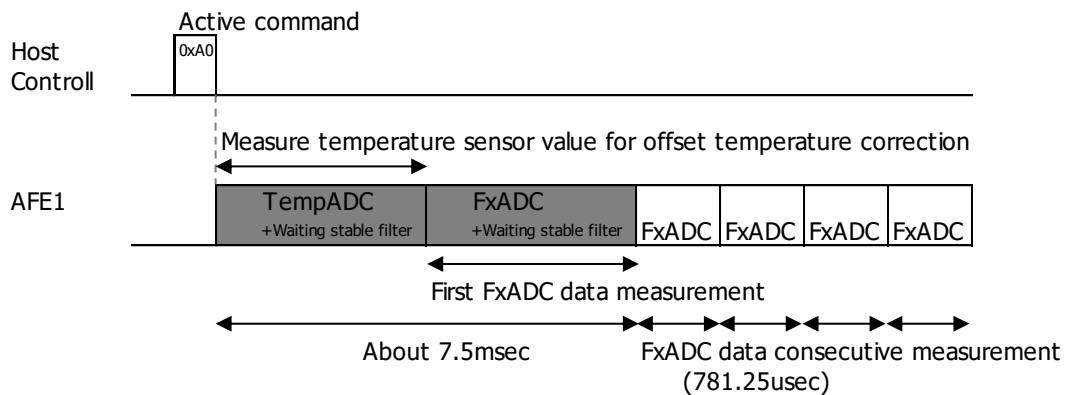

Fig. 10 Schematic of AD conversion start instruction

The second and subsequent ADC data are subject to offset temperature correction using temperature sensor values acquired during the initial AD conversion. This makes correction error larger with changes in ambient temperature, requiring regular update of the temperature sensor values. For update of temperature sensor values, refer to “[Update of temperature sensor value for offset temperature correction](#)”.

ADC data acquisition

To acquire ADC data (3 bytes / 24 bits), Result command should be issued to each AFE. For command code and format, refer to “[COMMAND CODE](#)” and “[SPI format](#)”. Fig. 11 schematically shows an example of ADC data acquisition from AFE1. Result command must be issued to all AFEs to acquire ADC data of all axes because matrix operation uses this data.

Each AFE returns the last AD-converted data when receiving Result command. If Result command is issued during the first AD conversion, ADC data will be 000000 h.

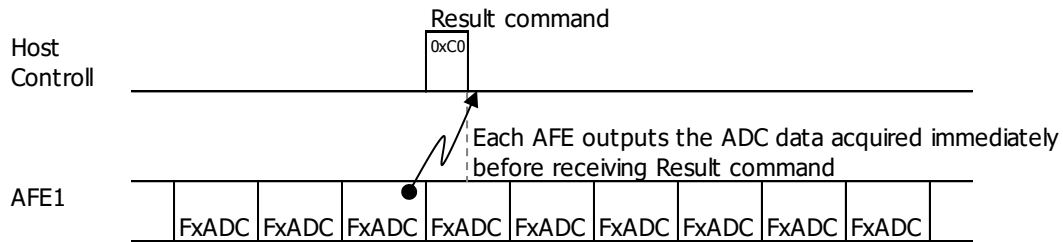

Fig. 11 Schematic of ADC data acquisition



Matrix operation

Please execute the matrix operation below by an external MCU, using matrix operation correction coefficients (3 bytes / 24 bits) and ADC data (3 bytes / 24 bits).

Matrix operation formula (note<sup>5</sup>)

$$\begin{pmatrix} A1 & A2 & A3 & A4 & A5 & A6 \\ B1 & B2 & B3 & B4 & B5 & B6 \\ C1 & C2 & C3 & C4 & C5 & C6 \\ D1 & D2 & D3 & D4 & D5 & D6 \\ E1 & E2 & E3 & E4 & E5 & E6 \\ F1 & F2 & F3 & F4 & F5 & F6 \end{pmatrix} \begin{pmatrix} FxADC \\ FyADC \\ FzADC \\ MxADC \\ MyADC \\ MzADC \end{pmatrix} = \begin{pmatrix} FxMD \\ FyMD \\ FzMD \\ MxMD \\ MyMD \\ MzMD \end{pmatrix}$$

Matrix operation correction coefficients  
(3 bytes / 24 bits)
ADC data  
(3 bytes / 24 bits)
Matrix operation data  
(Input range equal to or less than load capacity  
=> Max. 4 bytes / 32 bits)

Matrix operation data FxMD to MxMD should be right-shifted by 11 bits to convert the force into 0.001\*N and the moment into 0.00001\*N·m.

$$\begin{aligned}
 Fx &= FxMD \div 2^{11} [0.001*N] \\
 Fy &= FyMD \div 2^{11} [0.001*N] \\
 Fz &= FzMD \div 2^{11} [0.001*N] \\
 Mx &= MxMD \div 2^{11} [0.00001*N\cdot m] \\
 My &= MyMD \div 2^{11} [0.00001*N\cdot m] \\
 Mz &= MzMD \div 2^{11} [0.00001*N\cdot m]
 \end{aligned}$$

note<sup>5</sup>: Determinant expansion

$$\begin{aligned}
 FxMD &= A1 \times FxADC + A2 \times FyADC + A3 \times FzADC + A4 \times MxADC + A5 \times MyADC + A6 \times MzADC \\
 FyMD &= B1 \times FxADC + B2 \times FyADC + B3 \times FzADC + B4 \times MxADC + B5 \times MyADC + B6 \times MzADC \\
 FzMD &= C1 \times FxADC + C2 \times FyADC + C3 \times FzADC + C4 \times MxADC + C5 \times MyADC + C6 \times MzADC \\
 MxMD &= D1 \times FxADC + D2 \times FyADC + D3 \times FzADC + D4 \times MxADC + D5 \times MyADC + D6 \times MzADC \\
 MyMD &= E1 \times FxADC + E2 \times FyADC + E3 \times FzADC + E4 \times MxADC + E5 \times MyADC + E6 \times MzADC \\
 MzMD &= F1 \times FxADC + F2 \times FyADC + F3 \times FzADC + F4 \times MxADC + F5 \times MyADC + F6 \times MzADC
 \end{aligned}$$

- Matrix operation correction coefficient (A1 to F6)  
Matrix operation correction coefficient is 3 bytes (24 bits). A negative number is expressed by 2's complement.

Table 3 Example of matrix operation correction coefficient

HEX.	DEC.
800000 h	-8388608
FFFFFF h	-1
000000 h	0
000001 h	1
000800 h	2048
7FFFFFF h	8388607

- ADC data (FxADC to MzADC)  
ADC data is 3 bytes (24 bits). A negative number is expressed by 2's complement.

Table 4 Example of ADC data output

HEX.	DEC.
800000 h	-8388608
FF63C0 h	-40000
FFFFFF h	-1
000000 h	0
000001 h	1
009C40 h	40000
7FFFFFF h	8388607

- Matrix operation data (FxMD to MzMD)

According to calculations, the range of the matrix operation data is 6 bytes (48 bits). For the data measured at the load capacity or less, the range is 4 bytes (32 bits) at the maximum. The matrix operation data uses negative numbers expressed by 2's complement.

Table 5 Example of matrix operation data – force output

Matrix operation data HEX.	Matrix operation data After right-shift by 11 bits		Force [N]
	HEX.	DEC.	
E7960000 h ⋮ E79607FF h	FFFCF2C0 h	-200000	-200.000
FB1E0000 h ⋮ FB1E07FF h	FFFF63C0 h	-40000	-40.000
FFFFFF800 h ⋮ FFFFFFF h	FFFFFFFF h	-1	-0.001
00000000 h ⋮ 000007FF h	00000000 h	0	0.000
00000800 h ⋮ 00000FFF h	00000001 h	1	0.001
04E20000 h ⋮ 04E207FF h	00009C40 h	40000	40.000
186A07FF h ⋮ 186A0000 h	00030D40 h	200000	200.000

Table 6 Example of matrix operation data - moment output

Matrix operation data HEX.	Matrix operation data After right-shift by 11 bits		Moment [N·m]
	HEX.	DEC.	
EA070000 h ⌋ EA0707FF h	FFFD40E0 h	-180000	-1.80000
FB1E0000 h ⌋ FB1E07FF h	FFFF63C0 h	-40000	-0.40000
FFFFFF800 h ⌋ FFFFFFF h	FFFFFFF h	-1	-0.00001
00000000 h ⌋ 000007FF h	00000000 h	0	0.00000
00000800 h ⌋ 00000FFF h	00000001 h	1	0.00001
04E20000 h ⌋ 04E207FF h	00009C40 h	40000	0.40000
15F907FF h ⌋ 15F90000 h	0002BF20 h	180000	1.80000

Measurement finish instruction

Each AFE completes AD conversion and ends measurement when receiving Reset command or Shutdown command. For command code and format, refer to "[COMMAND CODE](#)" and "[SPI format](#)". Fig. 12 schematically shows an example of measurement finish instruction issued to AFE1. Measurement finish instruction must be issued to all AFEs.

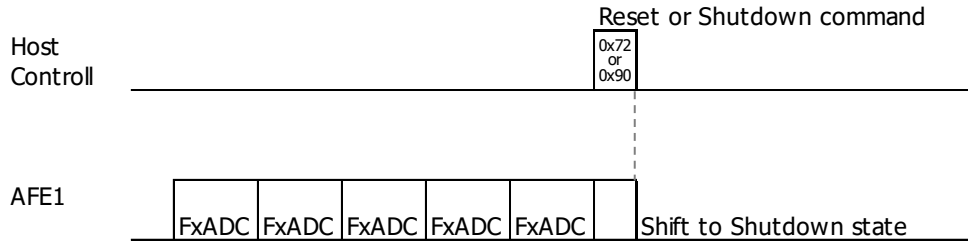

Fig. 12 Schematic of measurement finish instruction

Update of temperature sensor value for offset temperature correction

After AD conversion starts, the second and subsequent ADC data are subject to offset temperature correction using temperature sensor values acquired during the first AD conversion. This makes correction error larger with changes in ambient temperature, requiring regular update of the temperature sensor values.

Write Register command is used to update temperature sensor values for offset temperature correction. Fig. 13 schematically shows an example of the update of such data in AFE1. By executing Write Register command and writing data 0x01 to register address 0x3F at any timing, on-going AD conversion is completed, AD conversion of the temperature sensor is done again, and the data is updated. For command code and format, refer to "[COMMAND CODE](#)" and "[SPI format](#)".

The last ADC data can also be acquired during update of the temperature sensor values.

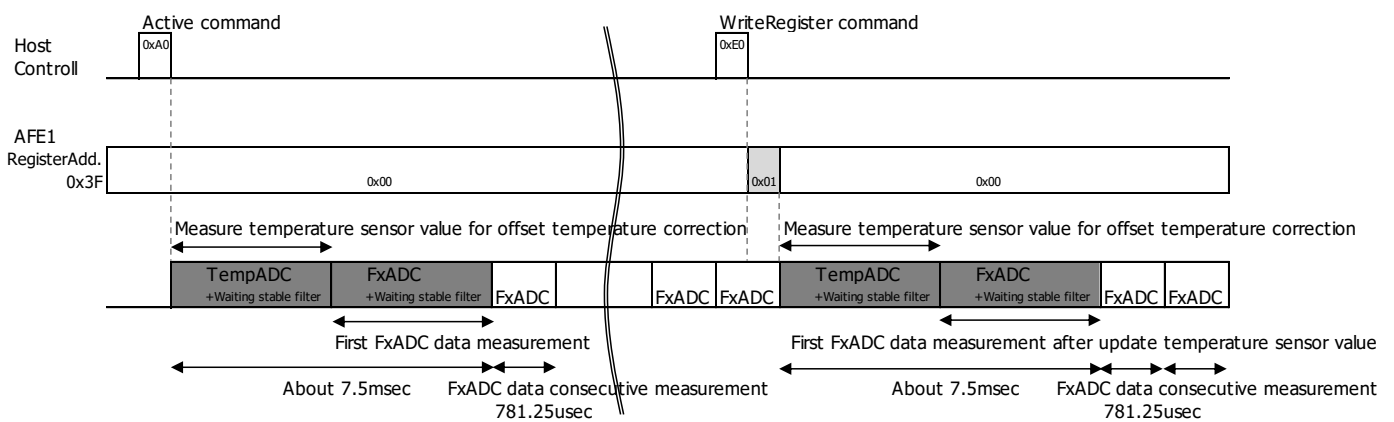
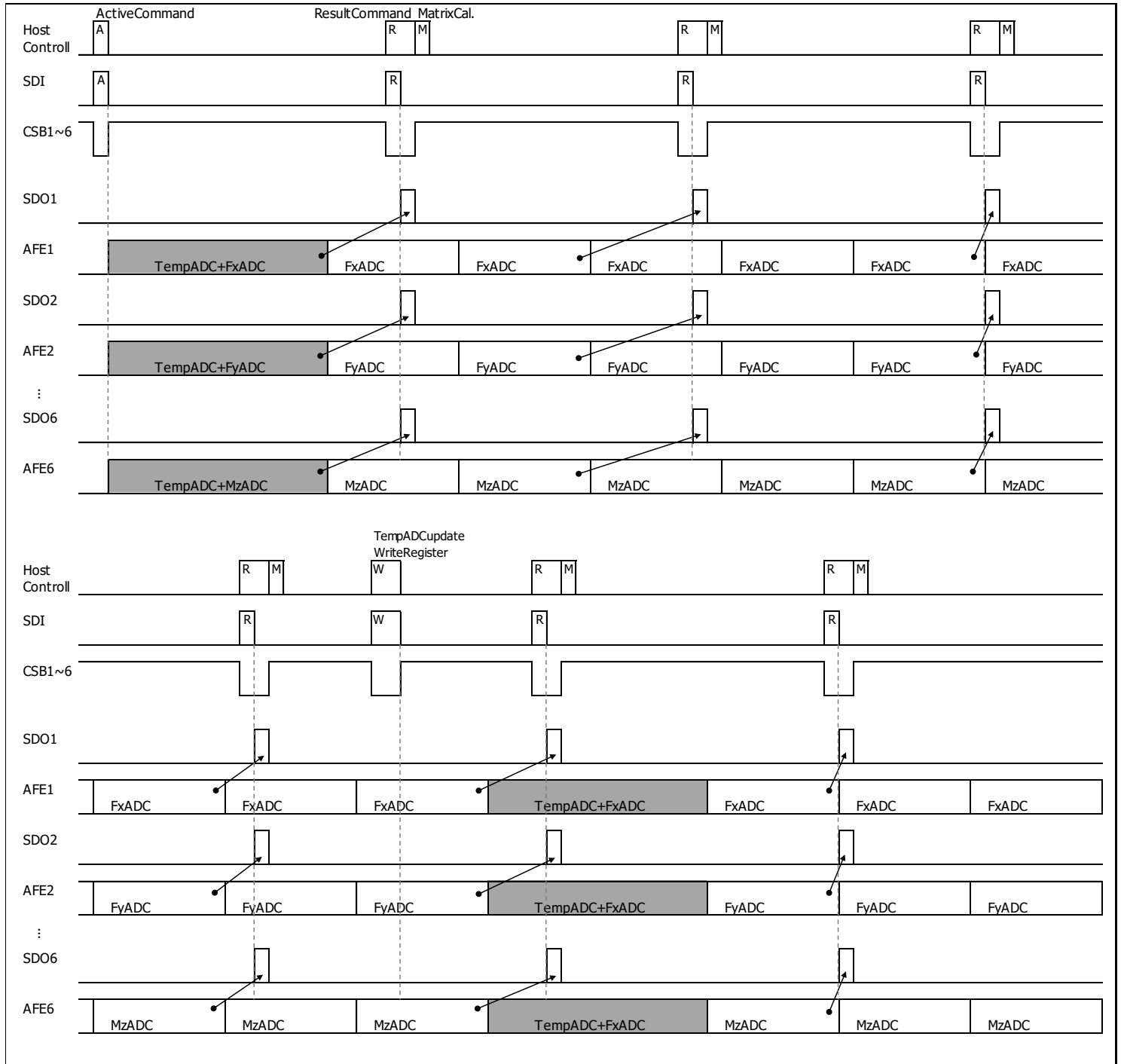

Fig. 13 Schematic of update of temperature sensor values for offset temperature correction

Measurement timing chart



\*AD conversion cycle depends on AFE because internal clock is different from each AFE.

Fig. 14 Integrated CSB pin - Measurement timing chart

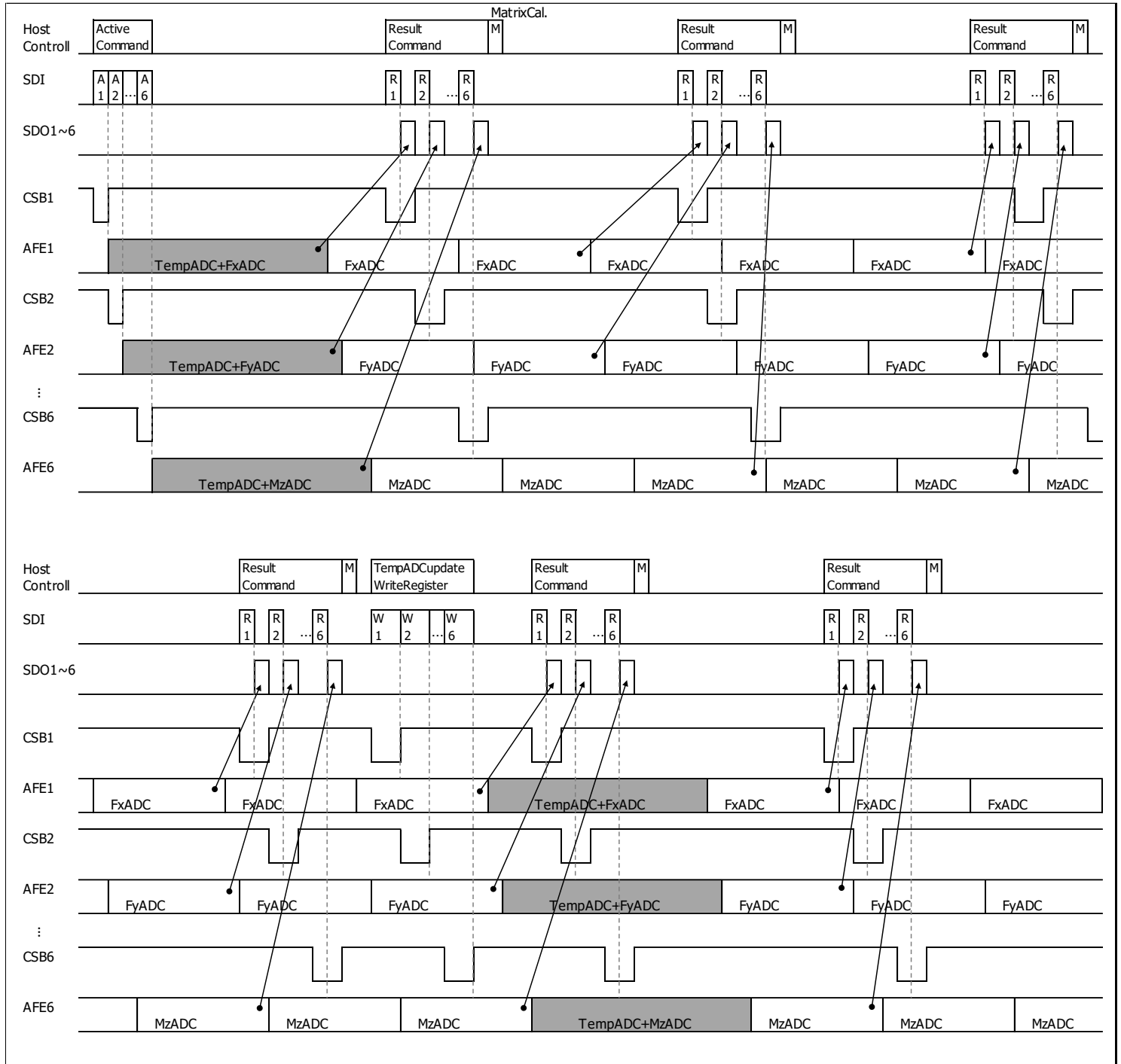

\*AD conversion cycle depends on AFE because internal clock is different from each AFE.

Fig. 15 Integrated SDO pin - Measurement timing chart



COMMAND CODE

Table 7 Command code list

Command Name	Command Code									Format																				
	HEX.	BIN.																												
		C7	C6	C5	C4	C3	C2	C1	C0																					
Reset	0x72	0	1	1	1	0	0	1	0	<a href="#">SPI Write format</a>																				
	Reset and Return to Shutdown state. It becomes busy for the maximum 1.8msec. Operation only with command code.																													
Shutdown	0x90	1	0	0	1	0	0	0	0	<a href="#">SPI Write format</a>																				
	Shift to Shutdown state. Operation only with command code.																													
Idle	0x94	1	0	0	1	0	1	0	0	<a href="#">SPI Write format</a>																				
	Start up the internal circuit and put it in the Idle state. Operation only with command code.																													
Active	0xA0	1	0	1	0	0	0	0	0	<a href="#">SPI Write format</a>																				
	Start AD conversion. Operation only with command code.																													
Read ADC Result	0xC0	1	1	0	0	0	0	0	0	<a href="#">SPI Write/Read format</a>																				
	ADC data (3 bytes /24 bits) is output MSB first. A negative number is expressed by 2's complement. For output range, positive output is 000000 h to 7FFFFFF h (0 to +8388607 in decimal number), while negative output is FFFFFFF h to 800000 h (-1 to -8388608 in decimal number). However, the measurement data acquired during the usage beyond the recommended operating conditions cannot be guaranteed.																													
Read Temperature ADC Result	0xC2	1	1	0	0	0	0	1	0	<a href="#">SPI Write/Read format</a>																				
	ADC data (3 bytes /24 bits) is output MSB first. A negative number is expressed by 2's complement. For output range, positive output is 000000 h to 7FFFFFF h (0 to +8388607 in decimal number), while negative output is FFFFFFF h to 800000 h (-1 to -8388608 in decimal number). However, the measurement data acquired during the usage beyond the recommended operating conditions cannot be guaranteed. Temperature value[°C] = DEC./2 <sup>16</sup> Output example																													
<table border="1"> <thead> <tr> <th colspan="2">BIN.</th> <th>HEX.</th> <th>DEC.</th> <th>Temperature</th> </tr> </thead> <tbody> <tr> <td>0000010100000000000000000000</td> <td>b</td> <td>050000 h</td> <td>327680</td> <td>5.000°C</td> </tr> <tr> <td>0001100100000000000000000000</td> <td>b</td> <td>190000 h</td> <td>1638400</td> <td>25.000°C</td> </tr> <tr> <td>0010110100000000000000000000</td> <td>b</td> <td>2D0000 h</td> <td>2949120</td> <td>45.000°C</td> </tr> </tbody> </table>											BIN.		HEX.	DEC.	Temperature	0000010100000000000000000000	b	050000 h	327680	5.000°C	0001100100000000000000000000	b	190000 h	1638400	25.000°C	0010110100000000000000000000	b	2D0000 h	2949120	45.000°C
BIN.		HEX.	DEC.	Temperature																										
0000010100000000000000000000	b	050000 h	327680	5.000°C																										
0001100100000000000000000000	b	190000 h	1638400	25.000°C																										
0010110100000000000000000000	b	2D0000 h	2949120	45.000°C																										
Write Register	0xE0	1	1	1	0	0	0	0	0	<a href="#">SPI Write format</a>																				
	It is used for writing data to register. After sending command code, send in the order of memory address of 8 bits and write data of 8 bits. After transmitting command code,																													
Read NVM	0xD6	1	1	0	1	0	1	1	0	<a href="#">SPI Write/Read format (Busy)</a>																				
	It is used for reading matrix operation correction coefficients.																													

The contents of this document are subject to change without notice.

©2020 Mitsumi co., Ltd. All rights reserved. MITSUMI ELECTRIC CO., LTD. Semiconductor Div.

[https://www.mitsumi.co.jp/latest/Catalog/index/index\\_e.html](https://www.mitsumi.co.jp/latest/Catalog/index/index_e.html)

STATE TRANSITION DIAGRAM

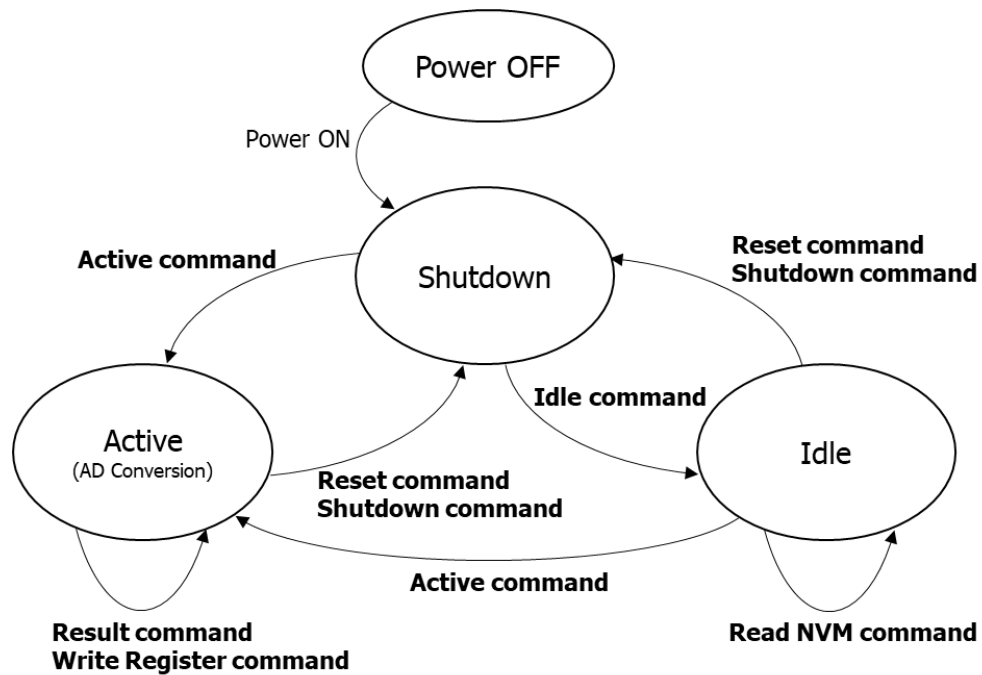

Fig. 16 State transition diagram

Table 8 State transition table

Command \ State	Shutdown	Active	Idle
Reset	Power on Reset & Initial Boot =>Shutdown state	Power on Reset & Initial Boot =>Shutdown state	Power on Reset & Initial Boot =>Shutdown state
Shutdown	=>Keep state	=>Shutdown state	=>Shutdown state
Active	Reset & Boot Load =>Active state (AD conversion)	Ignore(note <sup>6</sup> ) =>Keep state	=>Active state (AD conversion)
Result	Ignore(note <sup>6</sup> ) =>Keep state	Output result =>Keep state	Do not issue(note <sup>7</sup> ) =>Keep state
Idle	Reset & Boot Load =>Idle state	Do not issue(note <sup>8</sup> ) =>Idle state	=>Keep state
Write Register	Ignore(note <sup>6</sup> ) =>Keep state	Temperature ADC update =>Keep state	Do not issue(note <sup>9</sup> ) =>Keep state
Read NVM	Ignore(note <sup>6</sup> ) =>Keep state	Do not issue(note <sup>8</sup> ) =>Keep state	Output Matrix coeff. =>Keep state

note<sup>6</sup>: NACK is returned to the command.

note<sup>7</sup>: The correct result is not output. Additionally, ACK is returned to the command.

note<sup>8</sup>: Although command is acceptable, it goes unintended behavior since sequence is running.

note<sup>9</sup>: Although command is acceptable, it goes unintended behavior during sequence execution.

**SERIAL INTERFACE**

It supports SPI as an interface for serial communication.

Table 9 Baud rate

Items	Symbol	Condition	Min.	Typ.	Max.	Unit.
SPI communication speed	BR <sub>SPI1</sub>	VDDIO ≥ 2.0V Cb ≤ 100pF	-	-	5.0	Mbps
	BR <sub>SPI2</sub>	VDDIO < 2.0V Cb < 100pF	-	-	1.0	
	BR <sub>SPI3</sub>	VDDIO ≥ 2.0V Cb ≤ 400pF	-	-	2.5	
	BR <sub>SPI4</sub>	VDDIO < 2.0V Cb < 400pF	-	-	0.5	

**SPI format**

The basic format of SPI is shown below. The relationship between clock (SCLK) and data (SDI/SDO) is Mode3. Data send/receive is started when CSB becomes low level from the status when SCLK is high level. Data is updated on falling edges of the SCLK, and sampled on rising edges of the SCLK. Data send/receive is ended when CSB becomes high level from the status when SCLK is high level.

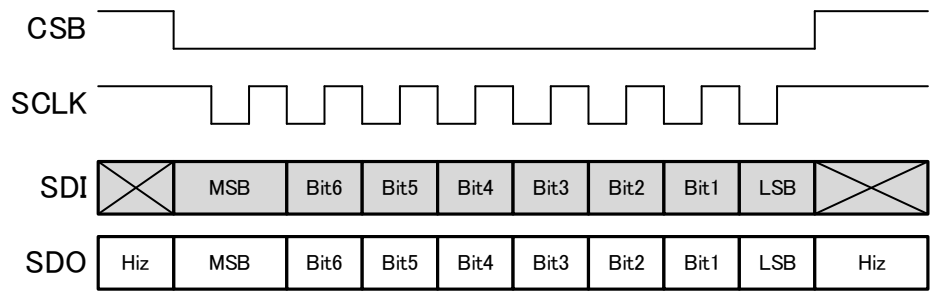

Fig. 17 SPI Waveform

**SPI Write format**

Please send command code of 8 bits. When the command is received, it turns over ACK to 8 bits. If there is data, please continue sending.

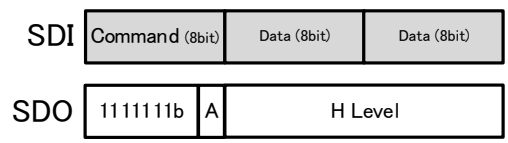

Fig. 18 SPI Write format

SPI Write/Read format

Please send command code of 8 bits. When the command is received, it turns over ACK to 8 bits and it outputs the data MSB first.

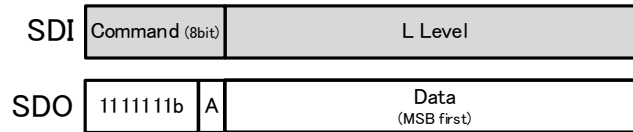

Fig. 19 SPI Write/Read format

SPI Write/Read format (Busy)

Please send command code of 8 bits. When their commands are received, it turns over ACK to 8 bits. Then, please send memory address of 8 bits. After receiving the memory address, the internal area becomes busy for 25usec at the maximum in order to prepare for data transmission. During this time, it returns 0x00 which indicates busy state. When data preparation is completed, it outputs 0x01, followed by data of 8 bits.

How to discern busy state:

Please continue clock input in the same communication status after transmitting the write data. Then, it returns 0x00 which indicates busy status. It returns 0x01 when writing is completed.

\* 0x00 to indicate busy may sometimes be output or not depending on the clock frequency.

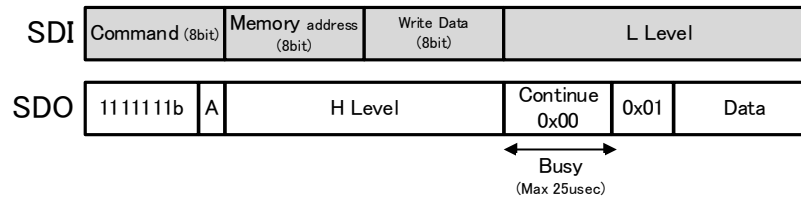

Fig. 20 SPI Write/Read format (Busy)

SPI ACK

When command code which is send in each SPI format is received, it outputs L level to 8 bits as ACK. If command code is not accepted or command code is not valid, it outputs H level to 8 bits as NACK.

SPI AC Characteristics

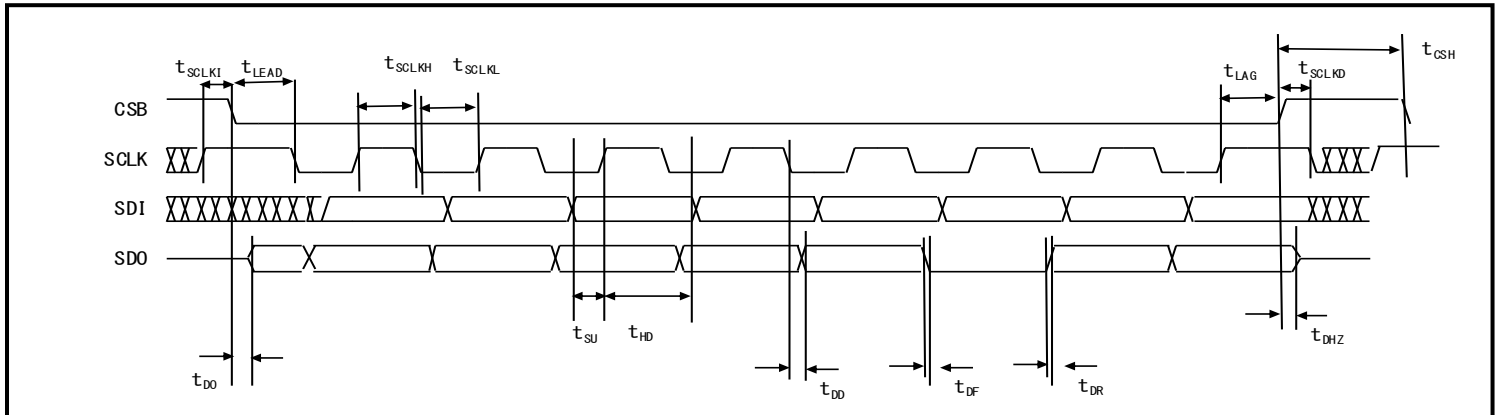

Fig. 21 SPI AC timing chart

Table 10 SPI AC Characteristics

Items	Symbol	VDDIO<2V		VDDIO≥2V		Unit.
		min.	max.	min.	max.	
SCLK frequency(Duty 50±10%)	$f_{SCLK}$	-	1	-	5	MHz
SCLK High period(90%~90%)	$t_{SCLKH}$	400	-	80	-	ns
SCLK Low period(10%~10%)	$t_{SCLKL}$	400	-	80	-	ns
SCLK wait time	$t_{SCLKI}$	500	-	100	-	ns
SCLK Delay time	$t_{SCLKD}$	0	-	0	-	ns
CSB High period(90%~90%)	$t_{CS}$	1000	-	200	-	ns
Time from CSB falling to SCLK falling	$t_{LEAD}$	0	-	0	-	ns
Time from SCLK rising to CSB rising	$t_{LAG}$	500	-	100	-	ns
SDI setup time	$t_{SU}$	100	-	10	-	ns
SDI hold time	$t_{HD}$	10	-	10	-	ns
SDO rise time(Load 100pF) (10%~90%)	$t_{DR}$	-	50	-	50	ns
SDO fall time(Load 100pF) (10%~90%)	$t_{DF}$	-	50	-	50	ns
SDO output delay time(Load 100pF)	$t_{DD}$	-	120	-	60	ns
SDO output delay time from CSB falling (Load 100pF)	$t_{DO}$	-	120	-	60	ns
Time from CSB rising to SDO output HiZ (Load 100pF)	$t_{DHZ}$	-	170	-	170	ns

The contents of this document are subject to change without notice.

©2020 Mitsumi co., Ltd. All rights reserved. MITSUMI ELECTRIC CO., LTD. Semiconductor Div.

[https://www.mitsumi.co.jp/latest/Catalog/index/index\\_e.html](https://www.mitsumi.co.jp/latest/Catalog/index/index_e.html)

TYPICAL APPLICATION CIRCUIT

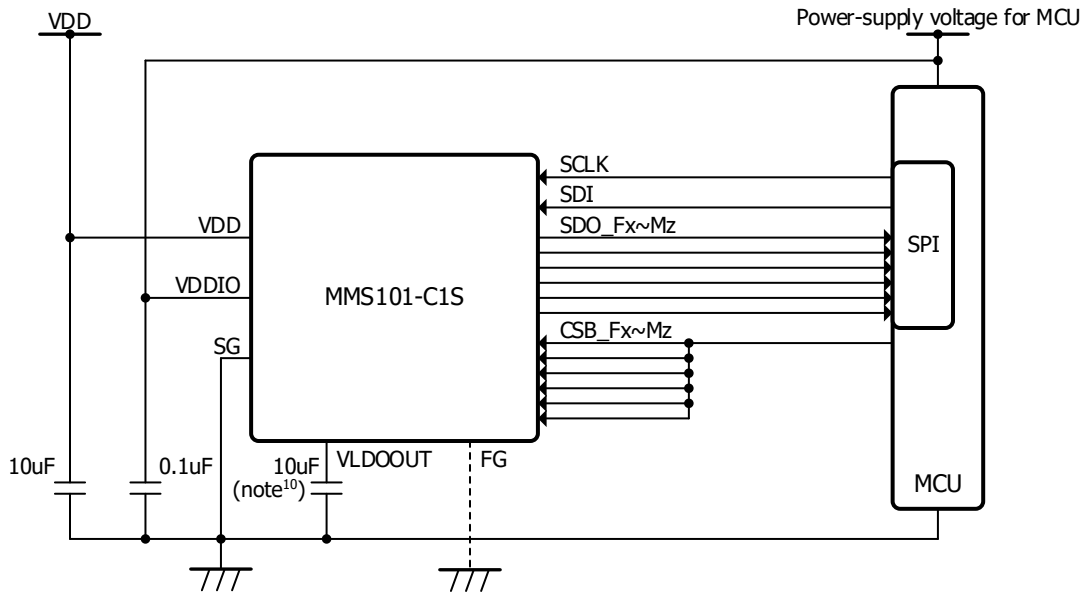

Fig. 22 Integrated CSB pin – Example application circuit

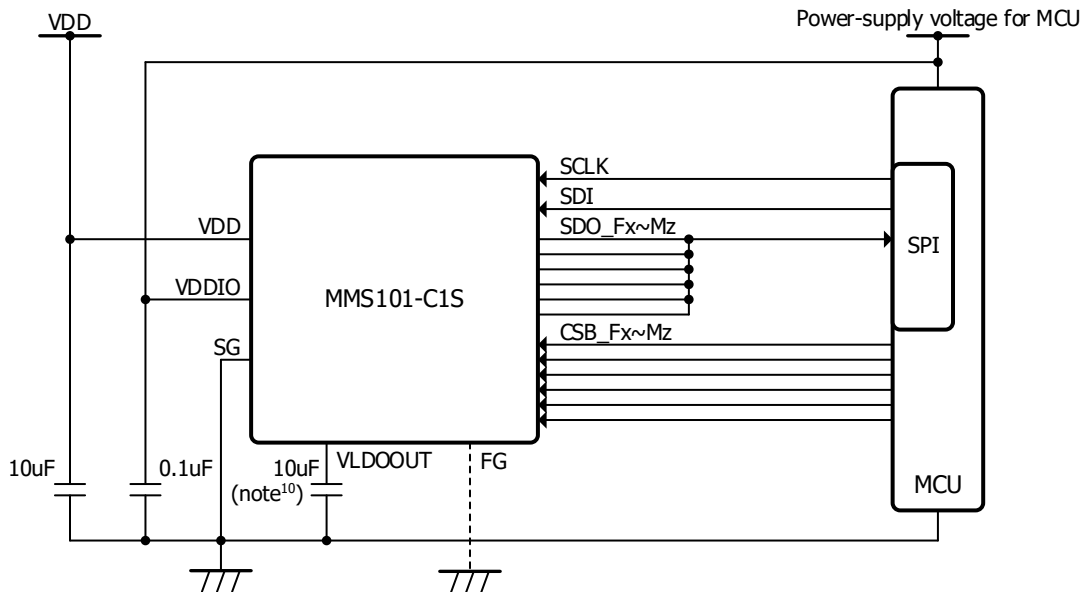

Fig. 23 Integrated SDO pin – Example application circuit

note<sup>10</sup>: It is recommended to be placed as close as possible for noise reduction.

DIMENSIONS

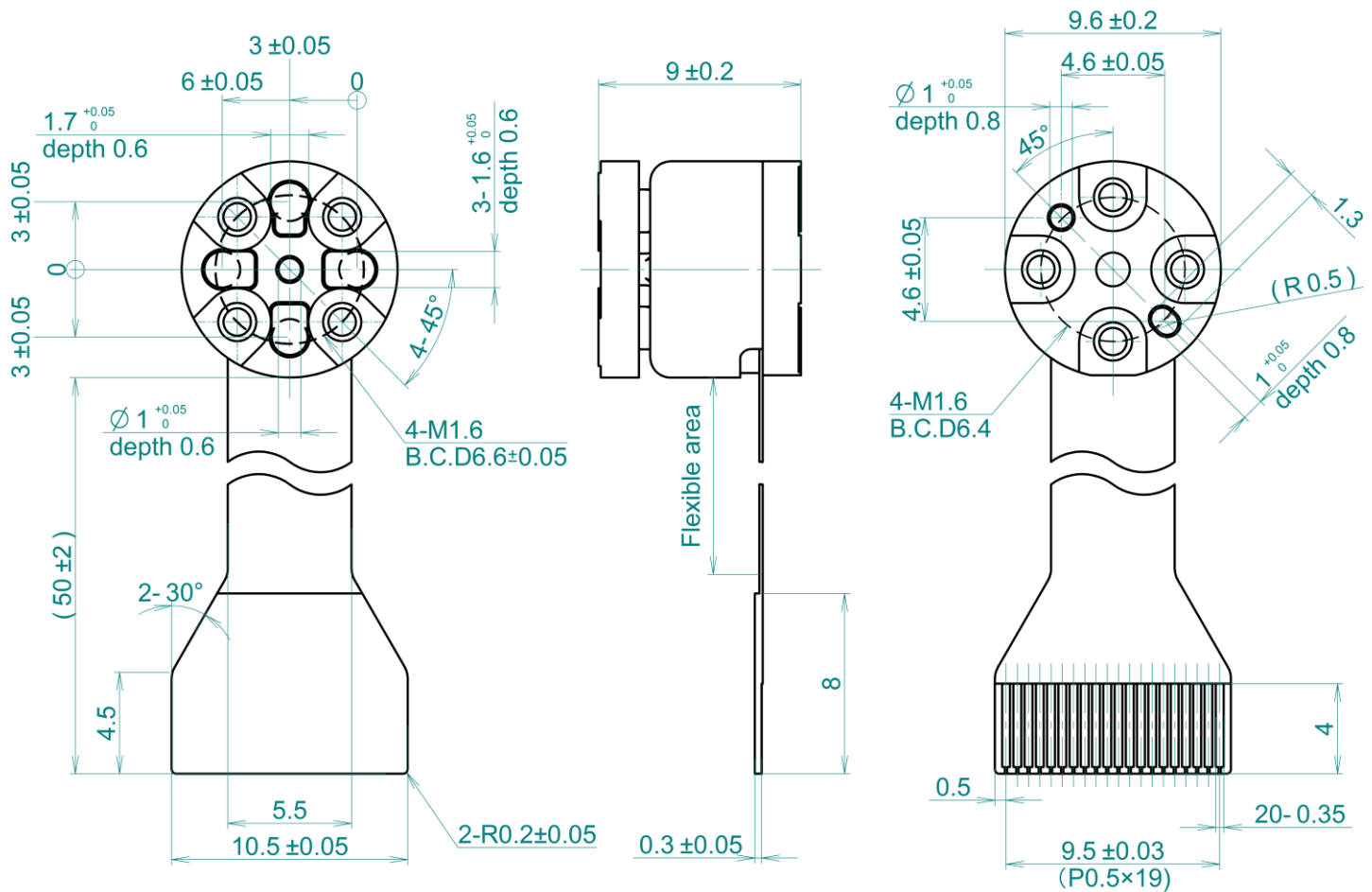

Fig. 24 Dimensions

- Recommended FPC connector
  - FH52K-20S-0.5SH (HIROSE ELECTRIC CO.,LTD)
  - FH28D-20S-0.5SH (HIROSE ELECTRIC CO.,LTD)
  - 046288020600846+ (KYOCERA Corporation)

Sensor coordination systems

\*The origin is the sensor top surface center.

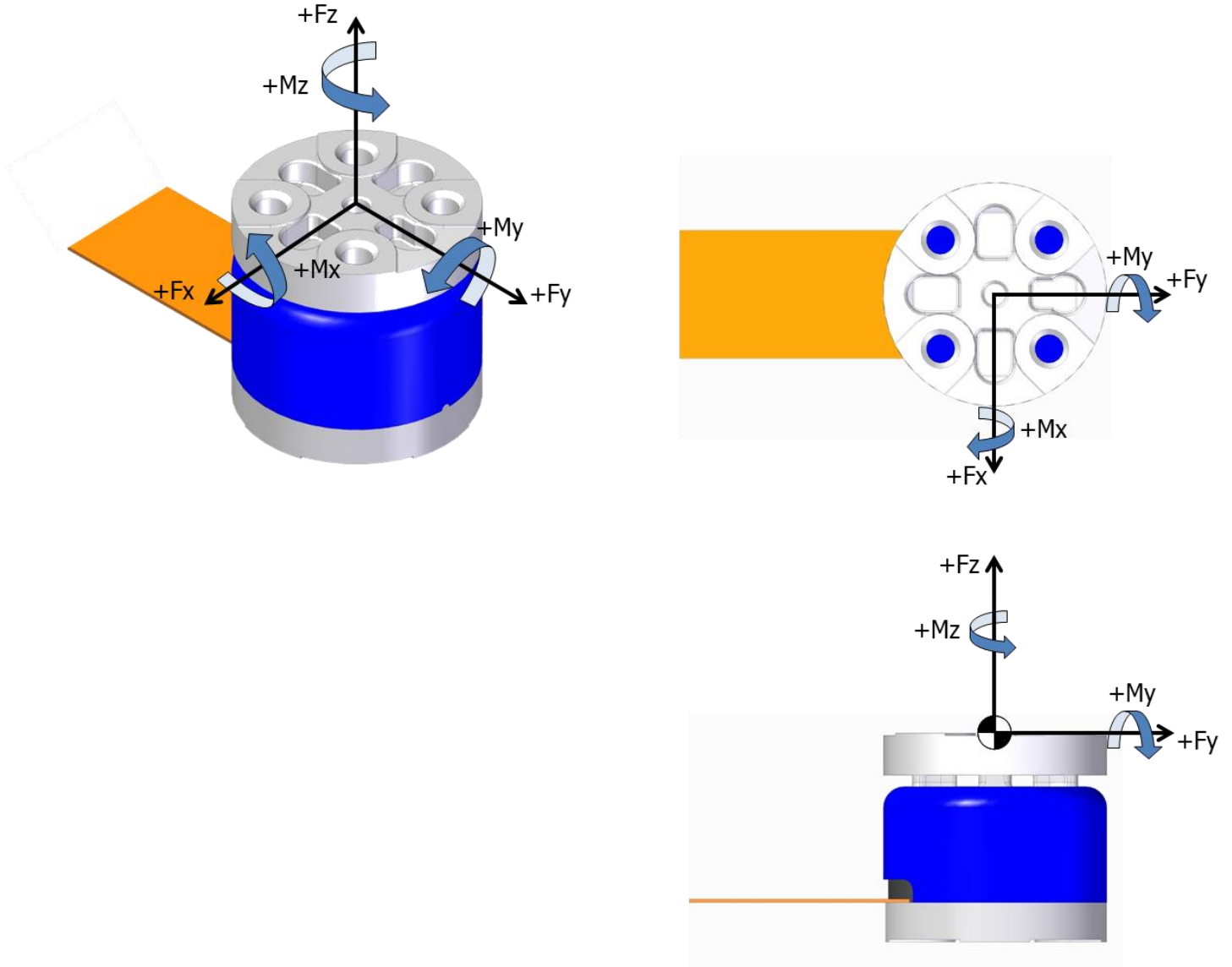

Fig. 25 Sensor coordination systems



Example of sensor attachment

It is important to minimize the attachment deformation during load application not to affect the sensor output. Therefore, the attachment should be designed to be hardly deformed by the load assumed in the normal use, using highly rigid materials such as SUS.

Fig. 26, 27 and 28 show examples of top & bottom side shape and installation of the attachment.

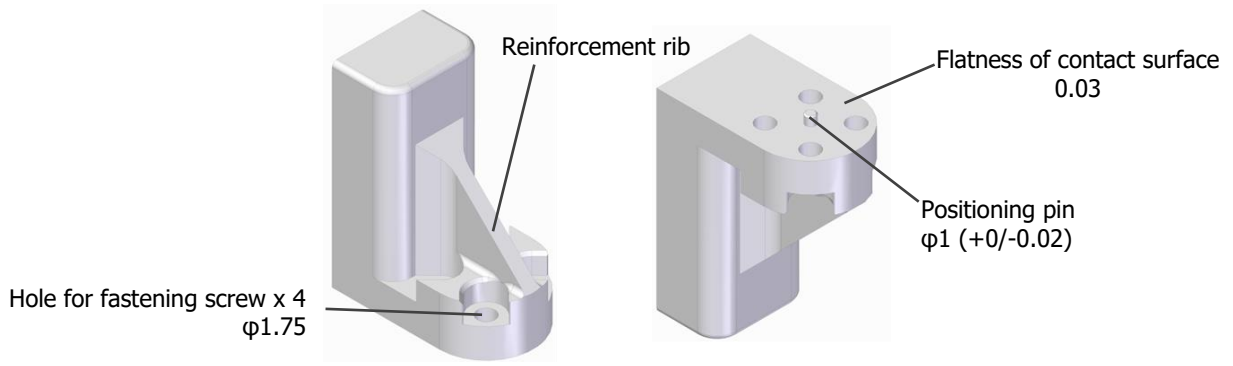

Fig. 26 Example of top side attachment

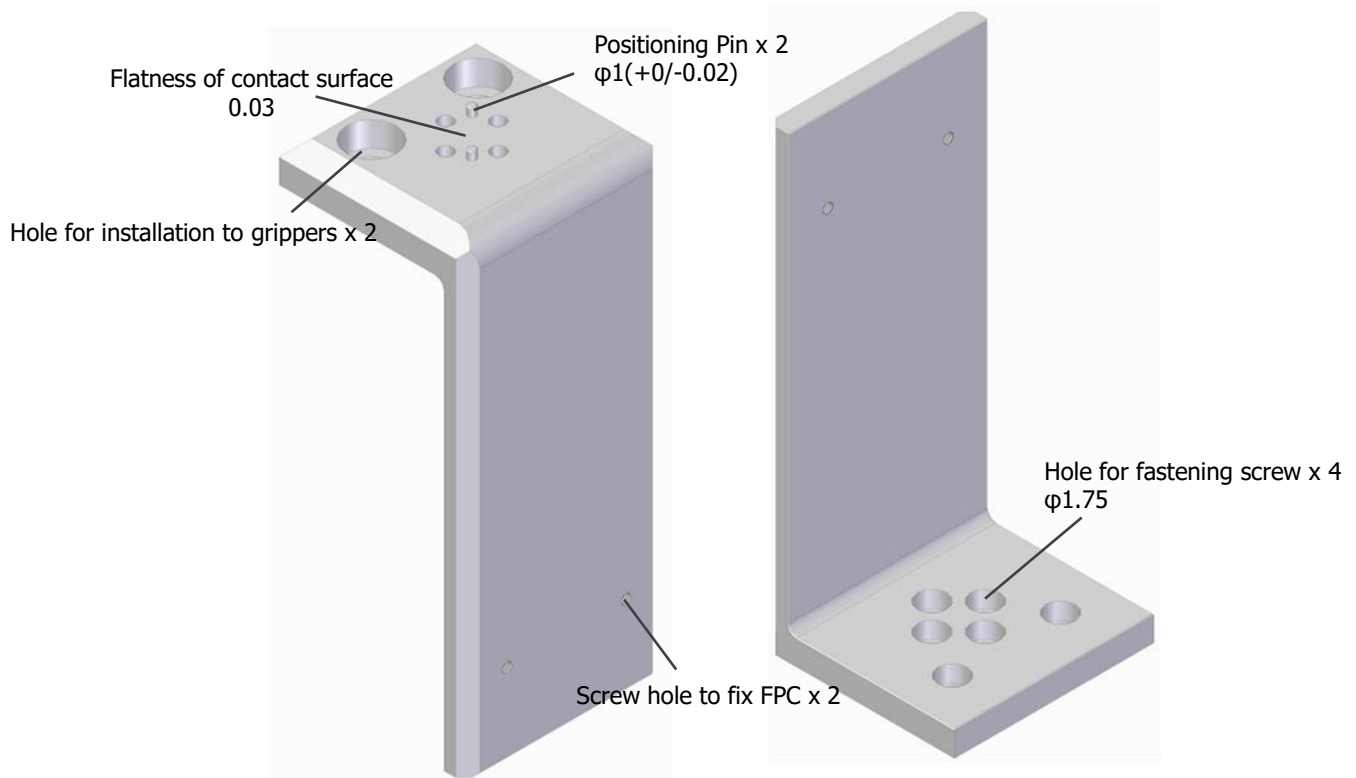

Fig. 27 Example of bottom side attachment

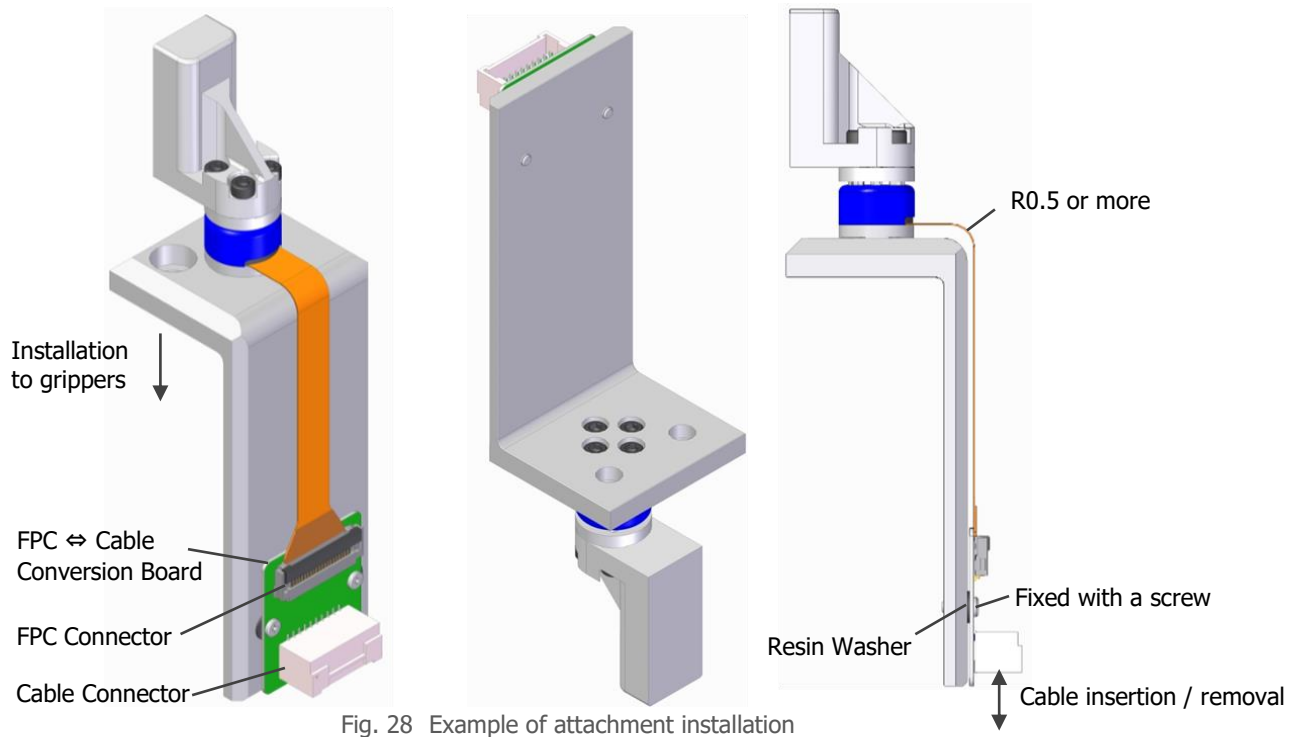

Fig. 28 Example of attachment installation

It is recommended to fix the board connected to FPC to the attachment with a screw so that the FPC is not bent repeatedly. Additionally, cables should be inserted and removed with the FPC fixed to the attachment with a screw to minimize load to the FPC.

Fig. 26, 27 and 28 show examples. The attachment should be designed depending on the intended use.

**PRECAUTIONS FOR SENSOR INSTALLATION**

This product is a precision measuring instrument. Therefore, it needs to be installed following the appropriate procedure to avoid overload to it. Failure to observe the recommendations included in this manual may cause damage to the sensor.

**Installation screw**

Four M1.6 screws should be used for installation on both top and bottom surfaces. **Length of the screws inserted in the installation holes of both surfaces should be 1.7 mm or shorter.** The tapped holes are 1.8 mm (min. 1.7 mm) through holes. Inserting a screw over 1.7 mm long could damage parts in the sensor.

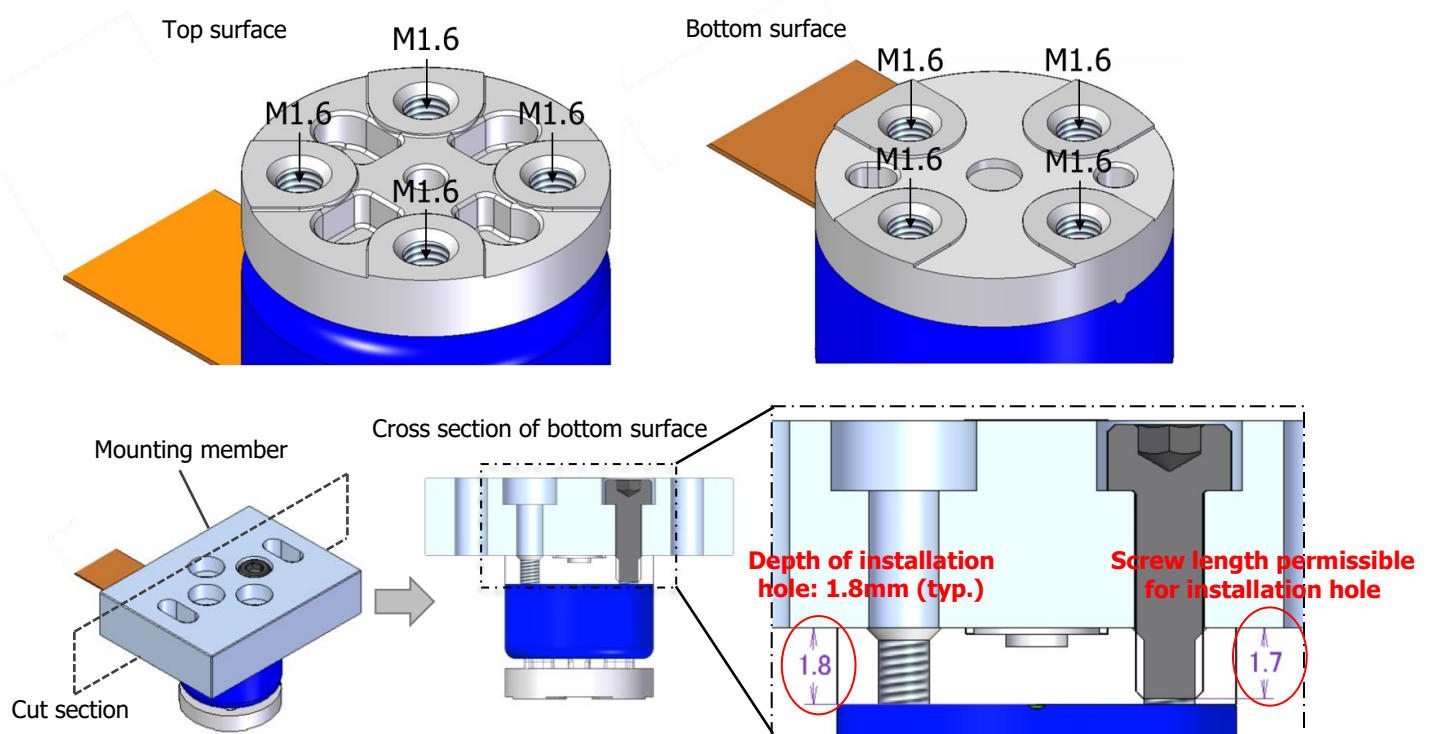

Fig. 29 Precautions for instillation screw

Positioning hole

For the top surface, a  $\phi 1$  round hole in the middle, a  $\phi 1.7$  round hole, or 1.6 x 1.45 mm square holes can be used for positioning. For the bottom surface, a  $\phi 1$  round hole and a  $\phi 1$  slotted hole can be used for positioning. For details, refer to "[DIMENSIONS](#)".

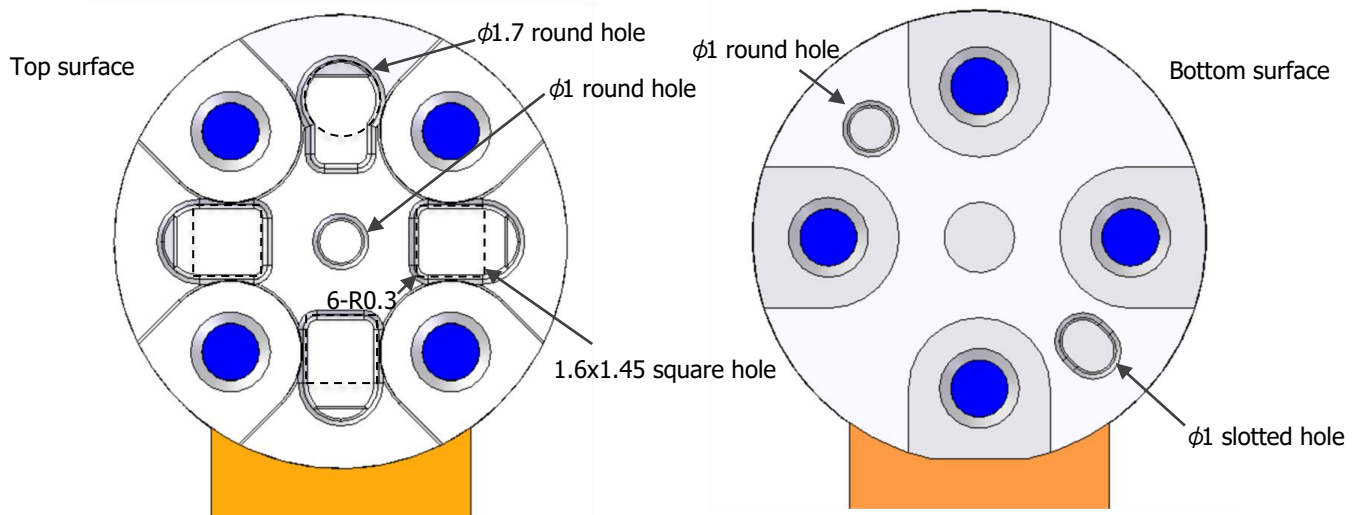
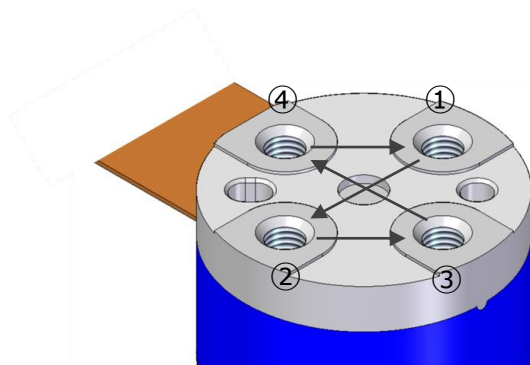

Fig. 30 Positioning holes

Recommended tightening method of sensor installation screw

**The recommended tightening torque is 0.15N·m for M1.6 screws used to install this sensor. DO NOT fasten one screw tightly at first step, or the sensor may detect incorrect force and moment. In the worst case, the sensor could be damaged.**

Screws must be fastened in the diagonal order as shown below. **First, they should be lightly fastened, and then, fastened in more than 2 steps with the recommended tightening torque.**



Ex. 1<sup>st</sup> round ①0.05N·m → ②0.05N·m → ③0.05N·m → ④0.05N·m  
 2<sup>nd</sup> round ①0.15N·m → ②0.15N·m → ③0.15N·m → ④0.15N·m

Fig. 31 Example of screw tightening order

### Sensor contact surface

Flatness of the sensor side contact surface is 0.03mm, and the installation side contact surface should be designed at the same flatness. Level difference resulting from poor flatness could cause the force and the moment to be detected incorrectly. In the worst case, the sensor could be damaged. The installation side contact surface needs to be rigid enough against loads.

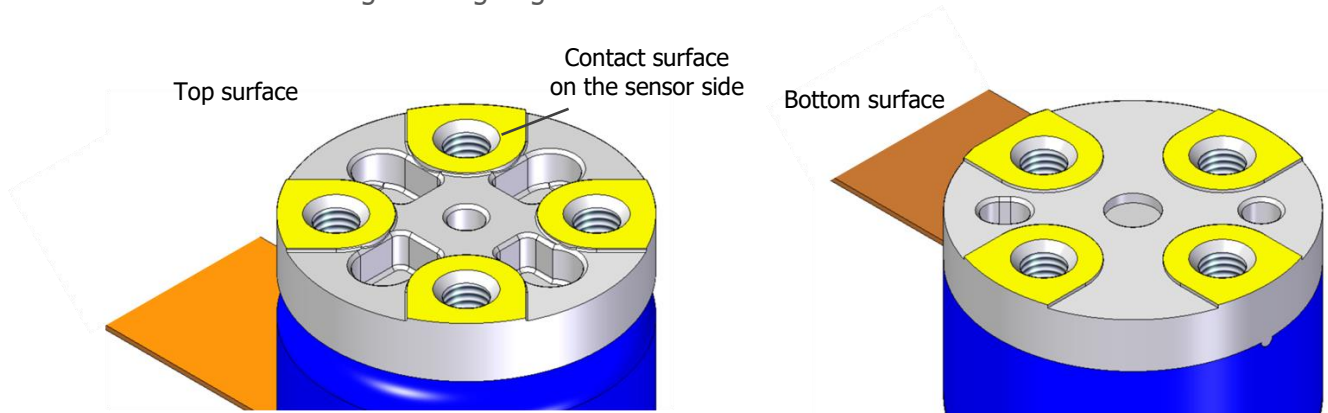

Fig. 32 Sensor side contact surface

**PRECAUTIONS FOR SENSOR HANDLE**

This product is a precision measuring instrument. Therefore, it needs to be handled following the appropriate procedure to avoid overload to it. Failure to observe the recommendations included in this manual may cause damage to the sensor.

**Handling of sensor FPC**

The FPC must NOT be strongly pulled in a lateral or the upper direction while the sensor body is fixed with screws. Otherwise, load is applied to the base of the FPC, and the wiring on the FPC might be snapped.

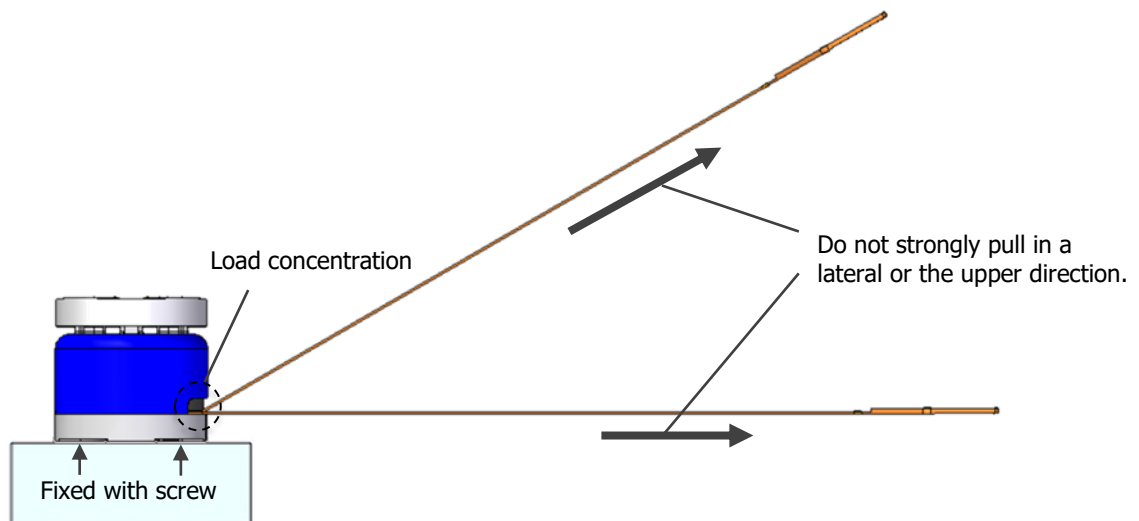

Fig. 33 Precaution for handling of sensor FPC - 1

In the FPC termination part, a level difference exists between the FPC and the reinforcing plate. Bending the FPC at this level difference part could cut the wiring on the FPC.

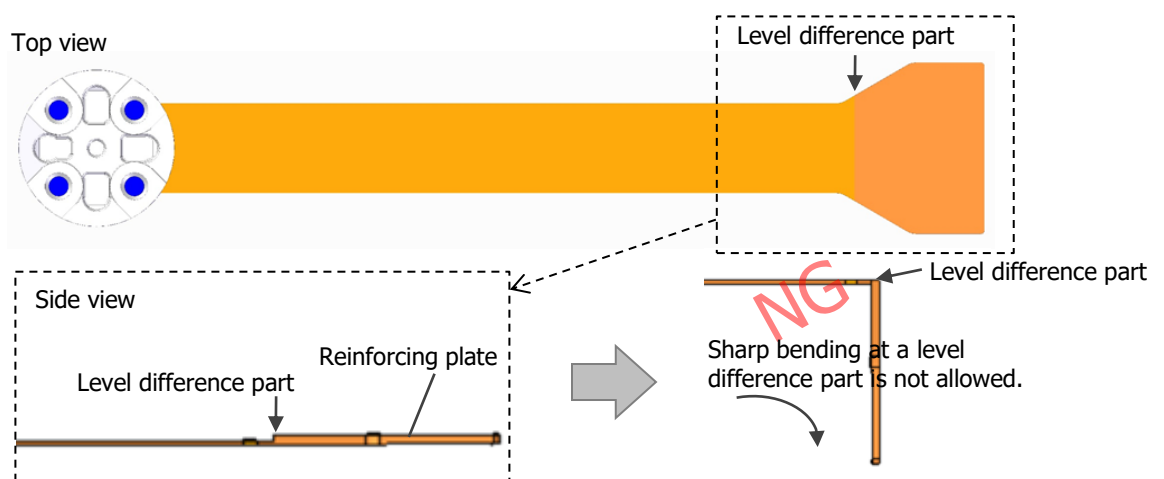

Fig. 34 Precaution for handling of sensor FPC - 2



**OPTION**

As options, evaluation kit and conversion board are available. Please order if necessary. However, the options are guaranteed only for checking the operation at the time of shipment, and will only be provided for sample support. Please note.

**Evaluation Kit**

Using evaluation kit with PC applications allows logging data to be acquired. In addition to product to which conversion board for evaluation kit are connected, they consist of cables and evaluation board. There are two kinds of evaluation kits. Select them according to the application.

Table 11 Evaluation Kit line-up

Evaluation Kit Name	Constitution
<p>Evaluation Kit 1 (Ver.2 Rev.0)</p>	 <p>*External communication: USB                  *USB cable is not included.                  -Required Spec. USB cable: USB ver.2.0/Type-C                  ◆ Manual: <a href="#">mms101_evaluationkit1_usb_manual_en_rev0.pdf</a>                  ◆ Document set: <a href="#">evaluationkit1_usb_en.zip</a>                  *You must enter an ID and password to download the document set. If necessary, contact our contact point.</p>
<p>Evaluation Kit 5 (Ver.1 E Rev.0)</p>	 <p>*External communication: Ethernet                  *Ethernet cable and AC adaptor are not included.                  -Required Spec. Ethernet cable :Cat5e or higher/ RJ-45 Plug                  -Required Spec. AC adaptor: Output DC voltage 5V/ Output current capacity 0.5A or more/                  Plug No. PL04B                  *Max. 5 sampled connectable                  ◆ Manual: <a href="#">mms101_evaluationkit5_ethernet_manual_en_rev0.pdf</a>                  ◆ Document set: <a href="#">evaluationkit5_ethernet_en.zip</a>                  *You must enter an ID and password to download the document set. If necessary, contact our contact point.</p>

Cable

Table 12 Cable line-up

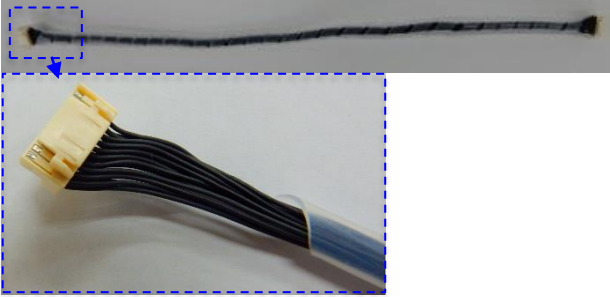
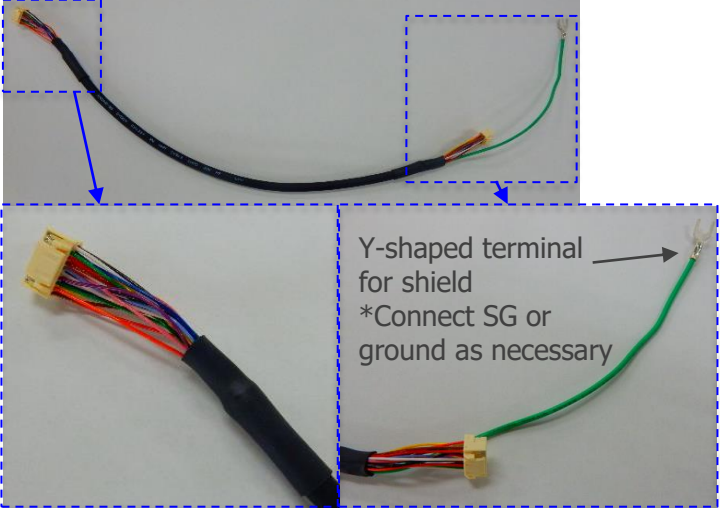
Cable Type	Cable length	Cable appearance
Lead cable	15, 30cm	 <ul style="list-style-type: none"> <li>Cable line: UL3302 AWG28 (FURUKAWA ELECTRIC CO.,LTD.)</li> <li>Diagram labels: UL3302 AWG28, Spiral tube, About 4.5mm</li> <li>Housing: NSHDR-20V-Z (J.S.T.MFG. CO., LTD)</li> </ul>
Robot cable	30, 60, 150cm	 <ul style="list-style-type: none"> <li>Cable line: RMDH II -SB (21913) (DYDEN CORPORATION)</li> <li>Diagram labels: AWG30, Braided Shield, Sheath, 5.1mm</li> <li>Housing: NSHDR-20V-Z (J.S.T.MFG.CO., LTD.)</li> <li>Shade terminal (Y type): 0.3Y-3 (NICHIFU CO., LTD.)</li> <li>Y-shaped terminal for shield *Connect SG or ground as necessary</li> </ul>

The contents of this document are subject to change without notice.

©2020 Mitsumi co., Ltd. All rights reserved.

MITSUMI ELECTRIC CO., LTD. Semiconductor Div.

[https://www.mitsumi.co.jp/latest/Catalog/index/index\\_e.html](https://www.mitsumi.co.jp/latest/Catalog/index/index_e.html)



Evaluation Board

Table 13 Evaluation Board line-up

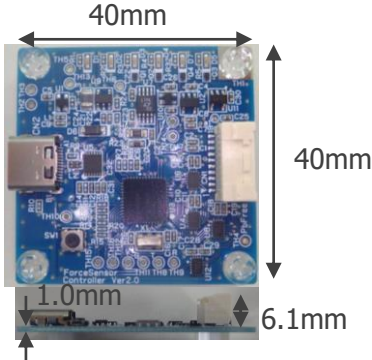
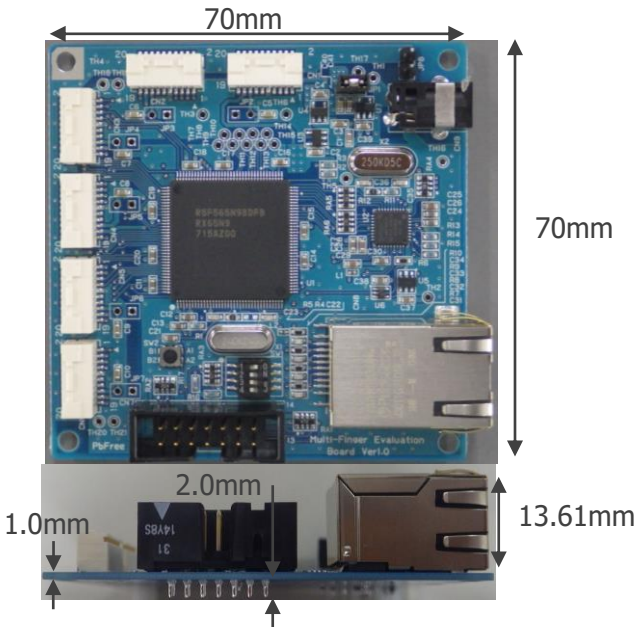
Board Name	External Communication	Power Supply	No. of connectable sensors	Board appearance
<p>ForceSensor ControllerBoard Ver2.0</p>	<p>USB</p>	<p>USB</p>	<p>Max. 1 pcs</p>	 <ul style="list-style-type: none"> <li>• Conversion Board side connector : SM20B-NSHDZS (J.S.T.MFG. CO., LTD)</li> <li>• External communication side connector : CAM-L05-024-050-ACGAA (MITSUMI ELECTRIC CO., LTD)</li> </ul>
<p>ForceSensor MultiFingerBoard Ver1.0</p>	<p>Ethernet</p>	<p>DC Jack</p>	<p>Max. 5 pcs</p>	 <ul style="list-style-type: none"> <li>• Conversion Board side connector : SM20B-NSHDZS (J.S.T.MFG. CO., LTD.)</li> <li>• External communication side connector : J3011G21DNL (Pulse Electronics CO., LTD.)</li> <li>• DC jack : M04-730A0 (MARUSHIN ELECTRIC MFG. CO., LTD)</li> </ul>

The contents of this document are subject to change without notice.

Conversion Board

Conversion Board is intended to connect a cable to this product. Connect the product terminal to the FPC connector and convert it to a cable connector with the number of pins according to the application.

Table 14 Conversion board line-up

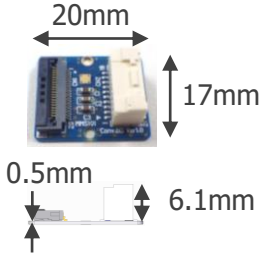
Board Name	Terminal conversion table				Board appearance	
Conv. BD Ver1.1 (For Evaluation Kit)	20pin				 <ul style="list-style-type: none"> <li>• Sensor side connector : FH52K-20S-0.5SH (HIROSE ELECTRIC CO.,LTD)</li> <li>• Control/Evaluation board side connector : SM20B-NSHDZS (J.S.T.MFG. CO., LTD.)</li> </ul>	
	MMS101 Output	Conv.BD Output	MMS101 Output	Conv.BD Output		
	VDD	VDD	CSB_Fz	CSB_Fz		
	VDDIO	VDDIO	CSB_Mx	CSB_Mx		
	VLDOOUT	VLDOOUT	CSB_My	CSB_My		
	SG	SG	CSB_Mz	CSB_Mz		
	FG	FG	SDO_Fx	SDO_Fx		
	FG	N.C.	SDO_Fy	SDO_Fy		
	SCLK	SCLK	SDO_Fz	SDO_Fz		
	SDI	SDI	SDO_Mx	SDO_Mx		
	CSB_Fx	CSB_Fx	SDO_My	SDO_My		
	CSB_Fy	CSB_Fy	SDO_Mz	SDO_Mz		

## NOTES

## NOTES

## 【Safety Precautions】

- Though Mitsumi Electric Co., Ltd. (hereinafter referred to as "Mitsumi") works continually to improve our product's quality and reliability, semiconductor products may generally malfunction or fail. Customers are responsible for complying with safety standards and for providing adequate designs and safeguards for their hardware, software and systems which minimize risk and avoid situations in which a malfunction or failure of this product could cause loss of human life, bodily injury, or damage to property, including data loss or corruption. Before customers use this product, create designs including this product, or incorporate this product into their own applications, customers must also refer to and comply with (a) the latest versions or all of our relevant information, including without limitation, product specifications, data sheets and application notes for this product and (b) the user's manual, handling instructions or all relevant information for any products which is to be used, or combined with this products. Customers are solely responsible for all aspects of their own product design or applications, including but not limited to (a) determining the appropriateness of the use of this product in such design or applications; (b) evaluating and determining the applicability of any information contained in this document, or in charts, diagrams, programs, algorithms, sample application circuits, or any other referenced documents; and (c) validating all operating parameters for such designs and applications. Mitsumi assumes no liability for customers' product design or applications.
- This product is intended for applying to computers, OA units, communication units, instrumentation units, machine tools, industrial robots, AV units, household electrical appliances, and other general electronic units.
- If you have any intentions to apply this product to the units related to the control and safety of transportation units (vehicles, trains, etc.), traffic signaling units, disaster-preventive & burglar-proof units, or the like, contact our sales representatives in advance.
- Don't apply this product to any aeronautical & space systems, submarine repeaters, nuclear power controllers, medical units involving the human life, Military-related equipment, or the like.
- Before using this product, even when it is not used for the usage written above, notify and present us beforehand if special care and attention are needed for its application, intended purpose, environment of usage, risk, and the design or inspection specification corresponding to them.
- If any damage to our customer is objectively identified to be caused by the defect of this product, Mitsumi is responsible for it. In this case, Mitsumi is liable for the cost limited to the delivery price of this product.

**【Application considerations during actual circuit design】**

- The outline of parameters described herein has been chosen as an explanation of the standard parameters and performance of the product. When you actually plan to use the product, please ensure that the outside conditions are reflected in the actual circuit and assembling designs.
- Before using this product, please evaluate and confirm the actual application with this product mounted and embedded.
- To investigate the influence by applied transient load or external noise, it is necessary to evaluate and confirm them with mounting this product to the actual application.
- Any usage above the maximum rating may destroy this product or shorten the lifetime. Be sure to use this product under the maximum rating.
- If you continue to use this product highly-loaded (applying high temperature, large current or high voltage; or variation of temperature) even under the absolute maximum rating and even in the operating range, the reliability of this product may decrease significantly. Please design appropriate reliability in consideration of power dissipation and voltage corresponding to the temperature and designed lifetime after confirming our individual reliability documents (such as reliability test report or estimated failure rate). It is recommended that, before using this product, you appropriately derate the maximum power dissipation (typically, 80% or less of the maximum value) considering parameters including ambient temperature, input voltage, and output current.

**【Precautions for Foreign Exchange and Foreign Trade Control Act】**

- If you export or take products and technologies in this document which are subject to security trade control based on the Foreign Exchange and Foreign Trade Act to overseas from Japan, permission of the Japanese government is required.

**【Prohibitions for Industrial Property Rights】**

- Since this document contains the contents related to our copyright and know-how, you are requested not to use this document for any purpose other than the application of this product.
- If a use of this product causes a dispute related to the industrial property rights of a third party, Mitsumi has no liability for any disputes except those which arise directly from the manufacturing and manufacturing method of our products.

**【Precautions for Product Liability Act】**

- No responsibility is assumed by us for any consequence resulting from any wrong or improper use or operation, etc. of this product.

## 【Others】

- Any part of the contents contained herein must not be reprinted or reproduced without our prior permission.
- In case of any question arises out of the description in this specification, it shall be settled by the consultation between both parties promptly.

## ATTENTION

- This product is designed and manufactured with the intention of normal use in general electronics. No special circumstance as described below is considered for the use of it when it is designed. With this reason, any use and storage under the circumstances below may affect the performance of this product. Prior confirmation of performance and reliability is requested to customers.
  - Environment with strong static electricity or electromagnetic wave
  - Environment with high temperature or high humidity where dew condensation may occur
- This product is not designed to withstand radioactivity, and must avoid using in a radioactive environment.

## ADDITIONAL NOTES

- In the event of any defect in this product, you may send us the product. Then, we will perform an appropriate analysis and consult with you about appropriate remedy for the problem proposed by our sole discretion.
- Handle with care to prevent foreign matter from entering the screw holes and product gaps.
- When installing this product, design it so that the length of the screw inserted into the product mounting hole is 1.7mm or less. The product mounting hole is a through hole. If it exceeds 1.7mm, the internal parts will be damaged or malfunction. Also, we recommend that the tightening torque of the screws during mounting be 0.15N·m.
- Do not bend the FPC at a sharp angle or pull it hard so that the load is concentrated. Otherwise, the wiring on the FPC may be broken, resulting in operation failure.

## MITSUMI ELECTRIC CO.,LTD.

Strategy Engineering Department Semiconductor Business Division

Tel: +81-46-230-3470 / <http://www.mitsumi.co.jp>

### Notes:

Any products mentioned this datasheet are subject to any modification in their appearance and others for improvements without prior notification. The details listed here are not a guarantee of the individual products at the time of ordering. When using the products, you will be asked to check their specifications.