

Datasheet

BT900-SA-0x, BT900-SC-0x
Intelligent BTv4.0 Dual-Mode Module

Version 1.13

REVISION HISTORY

Version	Date	Notes	Contributor(s)	Approver
1.0		Initial Version		Jonathan Kaye
1.1	13 Feb 2015	Added system clock and tick count period table.		Jonathan Kaye
1.2	24 Feb 2015	Edits to clarify OTA app download works over VSP (command mode)		Jonathan Kaye
1.3	01 July 2015	Updated SPP range to reflect <i>Up to 600 kpbs</i>		Ben Whitten
1.4	21 July 2015	Added Tape and Reel information		Maggie Teng
1.5	15 Oct 2015	Updated SIG Qualification section		Jonathan Kaye
1.6	19 Nov 2015	Updated Reel photos with correct labels		Maggie Teng
1.7	01 July 2015	Converted from HIG to Datasheet; changed to new template Minor updates throughout. Added section on BLE vSP.		Raj Khatri
1.8	30 Aug 2016	Updated Declarations of Conformity		Sue White
1.9	01 Feb 2017	Fixed error to Pin Definition table; removed <i>Do not connect</i> from the Comment column of Pin 39		Raj Khatri
1.10	03 May 2017	Updated the Declaration of Conformity with new RED standards		Jonathan Kaye
1.11	04 May 2017	Fixed typo in DoC		Sue White
1.12	31 Oct 2017	Fixed error in FCC/IC regulatory section		Jonathan Kaye
1.13	05 Mar 2019	Updated logos, URLs, and template styles		Sue White

CONTENTS

1	Overview and Key Features	4
2	Specifications	5
3	Hardware Specifications	7
3.1.	Block Diagram and Pin-out.....	7
3.2.	Pin Definitions	8
3.3.	Electrical Specifications.....	12
4	Power Consumption	17
4.1.	Power Consumption across Clock Frequencies	17
5	Functional Description	20
5.1.	Power Management (includes brown-out and power-on-reset).....	20
5.2.	Clocks and Timers	20
5.3.	Memory for <i>smart</i> BASIC Application Code and Data	21
5.4.	RF	21
5.5.	UART Interface	21
5.6.	SPI Bus	22
5.7.	I2C Interface.....	22
5.8.	General Purpose I/O, ADC, PWM/FREQ and Host-wakeup	23
5.8.1.	GPIO	23
5.8.2.	ADC.....	23
5.9.	nRESET pin	24
5.10.	nAutoRUN pin	24
5.11.	<i>smart</i> BASIC Runtime Engine Firmware Upgrade	24
5.12.	Wake-up BT900	24
5.13.	Low Power Modes.....	24
5.14.	BT and Wi-Fi Coexistence.....	25
5.15.	BLE vSP modes	25
5.16.	BT900-SA On-board Chip Antenna Characteristics	26
6	Hardware Integration Suggestions	27
6.1.	Circuit.....	27
6.2.	PCB Layout on Host PCB - General	28
6.3.	PCB Layout on Host PCB for BT900-SA.....	28
6.4.	External Antenna Integration with BT900-SC.....	29
7	Mechanical Details	30
8	Application Note for Surface Mount Modules	32
8.1.	Introduction	32
8.2.	Shipping	32
8.2.1.	Tray Package	32
8.2.2.	Tape and Reel Package Information.....	33
8.3.	Reflow Parameters.....	36
9	FCC and IC Regulatory Statements	37
9.1.	Power Exposure Information	38
9.2.	OEM Responsibilities	38
10	Japan (MIC) Regulatory	40
11	CE Regulatory	40
12	EU Declarations of Conformity	41
13	Ordering Information.....	42
14	Bluetooth SIG Qualification	42
15	Additional Assistance	43

1 OVERVIEW AND KEY FEATURES

BT900 Series modules from Laird make it easy to add Classic BT and Bluetooth Low Energy (BLE) functionality to small, portable, power-conscious devices, including those powered by batteries. The fully approved, programmable modules feature Laird's innovative, event-driven *smartBASIC* programming language, which significantly reduces OEM development risk and speeds time to market.

Based on the Cambridge Silicon Radio (CSR) 8811 silicon and a low power Cortex M3 microcontroller, the BT900 modules provide exceptionally low power consumption with outstanding wireless range, all within a compact footprint of 19 mm x 12.5 mm. The modules incorporate all the hardware and firmware required to support development of Dual Mode applications, including:

- Complete radio hardware
- UART, I2C, SPI, ADC, and GPIO interfaces
- Embedded BTv4.0 software stack
 - Classic BT profile - SPP
 - GATT Client and Peripheral modes

What makes the modules truly innovative is *smartBASIC*, an event-driven programming language that enables standalone operation of the module. Laird has extended the implementation of *smartBASIC* from the popular BL6xx series of single mode BLE modules into the BT900 series. This allows developers the flexibility of utilising the Core and BLE specific *smartBASIC* functions from the BL6xx series to create fully interchangeable BLE applications between these product ranges.

Without the need for any external processor, a simple *smartBASIC* application encapsulates the complete end-to-end process of reading, writing, and processing of sensor data and then using Classic Bluetooth or BLE to transfer it to / from any Bluetooth device. Ultimately *smartBASIC* accelerates initial development, creation of prototypes, and mass production by providing you with your own Bluetooth expert within the module.

In addition to carrying FCC modular, IC, CE and MIC approvals, BT900 modules are fully qualified as a Bluetooth product, enabling designers to integrate the modules in devices without the need for further Bluetooth testing. A low-cost developer's kit including simple software tools simplifies module integration and guarantees the fastest route to market.

Features and Benefits

- Bluetooth v4.0 - Dual Mode (Classic Bluetooth and BLE)
- External or Internal Antennas
- *smartBASIC* programming language
- Full Bluetooth EPL
- Compact Footprint
- Programmable TX power 8 dBm to -20 dBm
- RX sensitivity: -90 dBm
- Ultra low power consumption
- TX: 85 mA peak (at +8dBm)
- Standby Doze: 2.8 mA (see Power Consumption [Note 2](#))
- Deep Sleep: 2.7 uA
- UART, GPIO, ADC, PWM, FREQ output, TIMERS, I2C, and SPI interfaces
- Fast Time to Market
- FCC, CE, IC, and Japan certified; other certs on request
- No external components required

Application Areas

- Medical devices
- Wellness devices
- Automotive Diagnostic Equipment
- Bar Code Scanners
- Industrial Cable Replacement
- Home automation

2 SPECIFICATIONS

2.1. Specification Summary

Table 1: Specifications

Categories	Feature	Implementation
Wireless Specification	Bluetooth®	V4.0 – Dual-Mode
	Frequency	2.402 - 2.480 GHz
	Transmit Power	+ 8 dBm (maximum) Configurable down to -20 dBm
	Receive Sensitivity	-90 dBm (typical)
	Link Budget	98 dB
	Raw Data Rates (Air)	3 Mbps (Classic BT – BR/EDR)
Host Interface and Peripherals	UART Interface	TX, RX, CTS, RTS DTR, DSR, DCD, RI can be implemented in <i>smartBASIC</i> - using General Purpose I/O Default 115200, N, ,8, 1 From 1,200 to 921600 RX buffer size (1024 bytes)
	GPIO	18 (maximum – configurable) lines. O/P drive strength (4 mA) Pull-up resistor (33 KOhms) control (via <i>smartBASIC</i>) Read pin-level
	I2C Interface	1 (configurable from GPIO total). Up to 400 kbps
	SPI	1 (configurable from GPIO total). Up to 4 Mbps
	ADC Interface	2 channels (configured from GPIO total). Up to 12-bit resolution Conversion time 2.0uS (at VCC 2.7V to 3.6V) Reference voltage AVCC (external, same as VCC) pre-scaling to match BL600 ADC
	PWM or FREQ output	Output a PWM or FREQ on up to 3 GPIO output pins. PWM output duty cycle: 0%-100% PWM output frequency: 500 kHz FREQ output frequency: 0 MHz to 4 MHz (50% duty cycle)
	Wi-Fi-BT coexistence	3 dedicated pins
Profiles	Classic Bluetooth	SPP (Serial Port Profile) – Up to 600 kbps
	Bluetooth Low Energy	GATT Client & Peripheral – Any Custom Services
Maximum Connections	Classic Bluetooth	7 clients
	Bluetooth Low Energy	5 clients
Programmability	<i>smartBASIC</i>	On-board programming language similar to BASIC
	<i>smartBASIC</i> application	Via UART or Over the Air

Categories	Feature	Implementation
Control Protocols		Any that can be implemented using <i>smartBASIC</i> vSP – Virtual Serial Port for BLE – select Command Mode or Bridge Mode.
FW upgrade	<i>smartBASIC</i> runtime engine FW upgrade	Via UART
Coexistence	802.11 (Wi-Fi)	3 wire CSR schemes supported (Unity-3 for classic BT, Unity-3e for BLE)
Operating Modes	Self-contained Run Mode	Selected by nAutoRUN pin status: LOW (0V). Then runs \$autorun\$ (<i>smartBASIC</i> application) if it exists.
	Interactive Development Mode	HIGH (VCC). Then runs via at+run (and “file name” of <i>smartBASIC</i> application script).
Supply Voltage	Supply	1.8V – 3.6V (Note 6) 1.8V operation not supported in current FW. 3.3V operation only (2.8V-3.6V).
	Current	Max Peak Current (TX Power @ +8 dBm TX): 85 mA Standby Doze (waitevent) – 2.8mA (at 4MHz clock) (Note 5)
Power Consumption		Deep Sleep – 2.7 uA (external signal wakeup) See Note 5
	User Configurable Clocking	User configurable clocking (40MHz, 20MHz, 4MHz), so user can reduce current consumption further.
Physical	Dimensions	19 mm x 12.5 mm x 2.5 mm; Pad Pitch 0.8 mm
Environmental	Operating	-40°C to +85°C
	Storage	-40°C to +85°C
Miscellaneous	Lead Free	Lead-free and RoHS compliant
	Warranty	One Year
Development Tools	Development Kit	Development board and free software tools
Software Tools	Utilities	Windows, Android and iOS applications UART Firmware Upgrade
	Bluetooth®	Complete Declaration ID
Approvals	FCC / IC / CE / MIC	All BT900 Series

Module Specification Notes:

- Note 1** DSR, DTR, RI, and DCD can be implemented in the *smartBASIC* application.
- Note 2** With I2C interface selected, pull-up resistors on I2C SDA and I2C SCL **must** be connected externally as per I2C standard.
- Note 3** SPI interface (master) consists of SPI MOSI, SPI MISO, and SPI CLK. SPI CS is created by using any spare SIO pin within the *smartBASIC* application script allowing multi-dropping.

Module Specification Notes:

- Note 4** The BT900 module comes loaded with *smartBASIC* runtime engine firmware but does not come loaded with any *smartBASIC* application script (as that is dependent on customer-end application or use). Laird provides many sample *smartBASIC* application scripts covering the services listed. Additional BLE services are being added every quarter.
- Note 5** Deep sleep consumes 2.7uA of power when the BT900 internal radio chip 32.768kHz is used. The *smartBASIC* runtime engine firmware has SIO (DIO default function) input pins that are PULL-UP enabled by default. You may disable the internal PULL_UP through a *smartBASIC* application script.
- Note 6** 1.8V operation not supported in current *smartBASIC* runtime engine FW. 3.3V operation only (2.8V-3.6V).

3 HARDWARE SPECIFICATIONS

3.1. Block Diagram and Pin-out

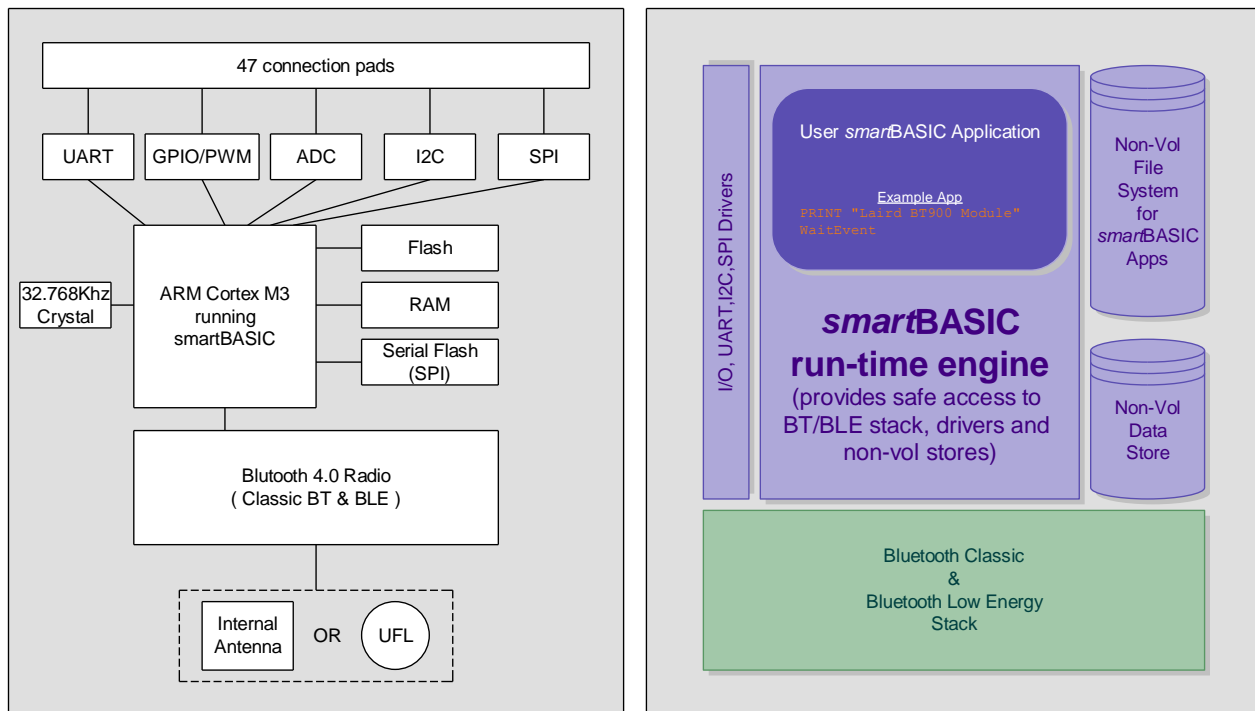

Figure 1: Functional HW and SW block Diagram for BT900 series Dual-Mode BT/ BLE smartBASIC module

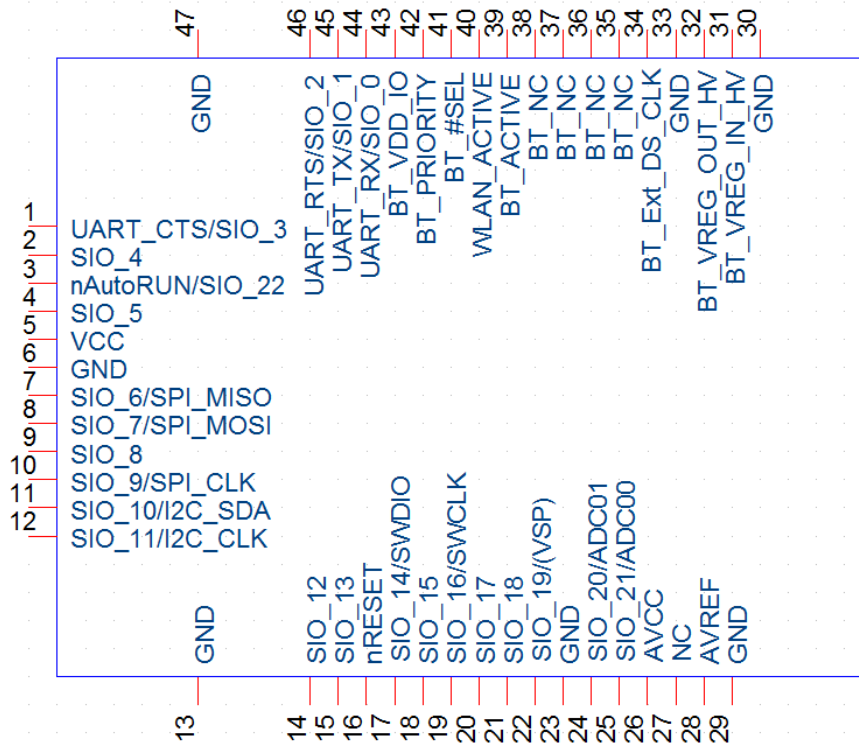

Figure 2: BT900-Sx module pin-out (top view)

3.2. Pin Definitions

Table 2: Pin definitions

Pin #	Pin Name	Default Funct.	Alternate Funct.	Default Direction	Supply Domain	Internal Pull-up or Pull-down State	Notes	Comment
1	UART_CTS	UART	SIO_3 or WKUP4 or Ext Interrupt	IN	VCC	Pull-up	1, 2, 6, 7, 12	
2	SIO_4	DIO		IN	VCC	Pull-up	2	Laird Devkit: UART_DTR via CON12
3	nAutoRUN		SIO_22 or Ext Interrupt	IN	VCC	Pull-up	In ONLY 1, 2, 12	Laird Devkit: UART_DSR via CON12
4	SIO_5	DIO	Ext Interrupt	IN	VCC	Pull Up	1, 2, 12	Laird Devkit: UART_DCD via CON12
5	VCC			IN	1.75V-3.6V	See Table 4	16	
6	GND	-	-	-	-	-	-	-

Pin #	Pin Name	Default Funct.	Alternate Funct.	Default Direction	Supply Domain	Internal Pull-up or Pull-down State	Notes	Comment
7	SIO_6	DIO	SPI MISO	IN	VCC	Pull Up	1, 2, 6, 9	SPIOPEN() in <i>smartBASIC</i> selects SPI function, MOSI and CLK are outputs when in SPI master mode. See Note 9
8	SIO_7	DIO	SPI MOSI	IN	VCC	Pull Up	1, 2, 6, 9	
9	SIO_8	DIO	Ext Interrupt	IN	VCC	Pull Up	1, 2, 12	Laird Devkit: UART_RI via CON12 or SPI_CS via CON16
10	SIO_9	DIO	SPI CLK	IN	VCC	Pull Up	1, 2, 6, 9	
11	SIO_10	DIO	I2C SDA	IN	VCC	Pull Up	1, 2, 6,	I2COPEN() in <i>smartBASIC</i> selects I2C function
12	SIO_11	DIO	I2C SCL	IN	VCC	Pull Up	1, 2, 6,	
13	GND	-	-	-	-	-	-	-
14	SIO_12	DIO	FREQ or PWM	IN	VCC	Pull Up	1, 2, 13	Laird Devkit: Buzzer output via CON15
15	SIO_13	DIO	FREQ or PWM	IN	VCC	Pull Up	1, 2, 13	Laird Devkit: Button1 input
16	nRESET			IN	VCC	Pull Up	8	System Reset (Active low)
17	SIO_14	DIO	*****	IN	VCC	N/A	2, 14	
18	SIO_15	DIO		IN	VCC	Pull Up	2	
19	SIO_16	DIO	*****	IN	VCC	N/A	2, 14	
20	SIO_17	DIO	FREQ or PWM	IN	VCC	Pull Up	1, 2, 13	Laird Devkit: LED1 via CON14
21	SIO_18	DIO		IN	VCC	Pull Up	2	Laird Devkit: LED2 via CON14
22	SIO_19	DIO	VSP	IN	VCC	Pull Up	1, 2, 10	Pull to GND externally (at power-up) to enter VSP Command mode (enable OTA functionality)
23	GND	-	-	-	-	-	-	-

Pin #	Pin Name	Default Funct.	Alternate Funct.	Default Direction	Supply Domain	Internal Pull-up or Pull-down State	Notes	Comment
24	SIO_20	DIO	AIN (ADC01) or WKUP1 or Ext Interrupt	IN	VCC	Pull Up	1, 2, 3, 4, 12	Laird Devkit: Button 2 input; Trim Pot via CON14
25	SIO_21	DIO	AIN (ADC00)	IN	VCC	Pull Up	1, 2, 3, 4	Laird Devkit: Temp Sensor input via CON14
26	AVCC			IN	1.7V-3.6V	See Table 4	16	
27	NC	NC						Reserved for future use. Do NOT connect.
28	AVREF			IN		See Table 4	16	
29	GND	-	-	-	-	-	-	-
30	GND	-	-	-	-	-	-	-
31	BT_VREG_IN_HV			IN only	3.3V	See Table 4	16	
32	BT_VREG_OUT_HV	DIO		IN only	1.8V	See Table 4	16	
33	GND	DIO	-	-	-	-	-	-
34	BT_Ext_DS_CLK	DIO		IN	BT_VDD_IO	Weak Pull-down		Do not connect
35	BT_NC	DIO		OUT	BT_VDD_IO	Weak Pull-down		Do not connect
36	BT_NC	DIO		OUT	BT_VDD_IO	Weak Pull-down		Do not connect
37	BT_NC			OUT	BT_VDD_IO	Weak Pull-down		Do not connect
38	BT_NC	NC		IN	BT_VDD_IO	Weak Pull-down		Do not connect
39	BT_ACTIVE	DIO		OUT	BT_VDD_IO	Weak Pull-down	17	
40	WLAN_ACTIVE	DIO		INs	BT_VDD_IO	Weak Pull-down	17	Also called WLAN_DENY
41	BT_#SEL	DIO		IN	BT_VDD_IO	Weak Pull-down	11	Must add 100K to GND externally
42	BT_PRIORITY	DIO		OUT	BT_VDD_IO	Weak Pull-down	17	Also called BT_STATUS
43	BT_VDD_IO			IN only	3.3V or 1.8V	See Table 4	16	

Pin #	Pin Name	Default Funct.	Alternate Funct.	Default Direction	Supply Domain	Internal Pull-up or Pull-down State	Notes	Comment
44	UART_RX	DIO	SIO_0 or WKUP2	IN	VCC	Pull-up	1, 2, 6, 7, 12, 15	UARTCLOSE() selects DIO functionality and UARTOPEN() selects UART comms behaviour
45	UART_TX	DIO	SIO_1	OUT	VCC	Set high in FW	1, 2, 6, 7, 15	
46	UART_RTS	DIO	SIO_2	OUT	VCC	Set low in FW	1, 2, 6, 7, 15	
47	GND	-	-	-	-	-	-	-

Module Pin Notes:

- Note 1** Alternate function is selectable in the *smartBASIC* application.
- Note 2** DIO – Digital Input or Output. I/O voltage level tracks VCC
- Note 3** AIN – Analog Input.
- Note 4** DIO or AIN functionality is selected using the `GpioSetFunc()` function in *smartBASIC*.
- Note 5** AIN configuration selected using `GpioSetFunc()` function.
- Note 6** I2C, UART, SPI controlled by `xxxOPEN()` functions in *smartBASIC*
- Note 7** SIO_0 to SIO_3 are DIO by default when \$autorun\$ app runs on power up.
- Note 8** Pull the nRESET pin low for minimum 500 nS in order for the BT900 to reset.

The BT900 module start-up time is ~1.6 seconds. Start-up time is the time taken from power-up to being able to run a *smartBASIC* command. Out of this, 1.6 seconds, ~1.3 seconds is for radio initialisation. 1.6 seconds is also the time when coming out of reset through AT command (ATZ) or AT command for factory default (at&f*).

For robustness against external interference, you must fit an external pull-up resistor (10K) on nRESET (pin 16) to VCC for BT900 to be out of reset. By default, the module is out of reset (internal weak-pull-up, 33k) when power is applied to the VCC pin
- Note 9** SPI CS is created by the customer using any spare SIO pin within their *smartBASIC* application script allowing multi-dropping.
- Note 10** It is possible to download smart BASIC applications Over the Air (OTA) to the BT900. To enable this feature, SIO_19 must be pulled low to GND externally (on power up). Refer to the firmware release documentation for details.
- Note 11** You must connect 100 K pull-down resistor on BT_#SEL externally to GND.
- Note 12** UART_CTS (pin 1), UART_RX (pin 44) and SIO_20/ADC01 (pin 24) are WKUP (wake-up) pins that allow the BT900 module to be woken up from Deep Sleep by the host. *smartBASIC* function will be added in the future to allow you to select which WKUP pin (or all) from which to wake up.
- Note 13** PWM output signal is an alternative function on SIO_12, SIO_13 and SIO_17. FREQ output signal is an alternative function on SIO pins SIO_12, SIO_13, SIO_17. Up to three SIO pins are allowed to output FREQ signal or PWM signal. Refer to *smartBASIC* User Guide for details.

Module Pin Notes:

- Note 14** It is mandatory that you specifically set script SIO_14 and SIO_16 as either input or output in your *smartBASIC* application to make SIO_14 and SIO_16 as GPIO's.
- Note 15** *smartBASIC* runtime engine firmware has DIO (default function) input pins that are PULL-UP enabled by default. You can disable internal PULL_UP through your *smartBASIC* application script. All the SIO pins (with a default function of DIO) are mostly inputs (unless stated otherwise in Table 2) – with no internal pull-up. SIO_1 and SIO_2 are outputs:
- SIO_1 (alternative function UART_TX) is an output, set high (in FW)
 - SIO_2 (alternative function UART_RTS) is an output, set low (in FW)
 - SIO_0 (alternative function UART_RX) is an input, set with internal
 - SIO_3 (alternative function UART_CTS) is an input, set with internal pull-up
 - SIO_19 is an input, needs an external pull-down. It is used for download *smartBASIC* applications over-the-air. See the latest FW release documentation for details.
- Note 16** 1.8V operation not supported in current *smartBASIC* runtime engine FW hence Customer must operate BT900 from nominal 3.3V supply (2.8V-3.6V, refer to Table4, note4). To operate BT900 from 3.3V connect the external 3.3V supply to pin 31 (BT_VREG_IN_HV), pin 5 (VCC), and pin 43 (BT_VDD_IO). Customer **MUST** leave pin 32 (BT_VREG_OUT_HV) unconnected.
- Note 17** Dedicated BT900 BT-WiFi coexistence pins for CSR scheme Unity3 (used for classic BT) and Unity3e (used for BLE). Refer to *smartBASIC* user manual for details on how to enable coexistence.

The BT900 module is delivered with the integrated *smartBASIC* runtime engine FW loaded (but no onboard *smartBASIC* application script). Because of this, it starts up in AT command mode by default.

At reset, all SIO lines are configured as the defaults shown above.

SIO lines can be configured through the *smartBASIC* application script to be either inputs (with pull-ups or none) or outputs. When an alternative SIO function is selected (such as I2C or SPI), the firmware does not allow the setup of internal pull-up. Therefore, when I2C interface is selected, pull-up resistors on I2C SDA and I2C SCL **MUST** be connected externally as per I2C standard.

UART_RX, UART_TX, UART_CTS are 3.3 V level logic (if VCC is 3.3 V, i.e. SIO pin I/O levels track VCC). For example, when RX and TX are idle, they sit at 3.3 V (if VCC is 3.3 V). Conversely, handshaking pins CTS and RTS at 0 V are treated as assertions.

Pin 3 (nAutoRUN) is an input, with active low logic. In the development kit (DVK-BT900-sx) it is connected so that the state is driven by the host's DTR output line. The nAutoRUN pin must be externally held high or low to select between the following two BT900 operating modes:

- Self-contained Run mode (nAutoRUN pin held at 0 V).
- Interactive / development mode (nAutoRUN pin held at VCC).

smartBASIC runtime engine firmware checks for the status of nAutoRUN during power-up or reset. If it is low and if there is a *smartBASIC* application script named **\$autorun\$**, then the *smartBASIC* runtime engine FW executes the application script automatically; hence the name *Self-contained Run Mode*.

3.3. Electrical Specifications

3.3.1. Absolute Maximum Ratings

Absolute maximum ratings for supply voltage and voltages on digital and analogue pins of the module are listed below. Exceeding these values causes permanent damage.

The average SIO pin output current is defined as the average current value flowing through any one of the corresponding pins for a 100ms period. The total average SIO pin output current is defined as the average current value flowing through all of the

corresponding pins for a 100mS period. The maximum output current is defined as the value of the peak current flowing through any one of the corresponding pins.

Table 3: Maximum Current Ratings

Parameter	Min	Max	Unit
Voltage at VCC pin	-0.3	+3.6	V
AVCC	VSS-0.5	VSS+4.6	V
AVREF	VSS-0.5	VSS+4.6	V
BT_VREG_IN_HV	2.3	4.8	V
BT_VREG_OUT_HV	1.7	2.0	V
BT_VDD_IO	-0.4	3.6	V
Voltage at GND pin		0	V
Voltage at SIO pin	-0.3	VCC+0.3	V
SIO "L" level average output current		4	mA
SIO "H" level average output current		-4	mA
SIO "L" level maximum output current		10	mA
SIO "H" level maximum output current		-10	mA
SIO "L" level total average output current		50	mA
SIO "H" level total average output current		-50	mA
SIO "L" level total maximum output current		100	mA
SIO "H" level total maximum output current		-100	mA
Storage temperature	-40	+85	°C

3.3.2. Recommended Operating Parameters

Table 4: Power Supply Operating Parameters

Parameter	Min	Typ	Max	Unit
VCC (Note 1, Note4)	1.75	3.3	3.6	V
AVCC (AVCC=VCC) (Note 1)	1.75	3.3	3.6	V
AVREF ¹ (when AVCC>=2.7V) AVREF ¹ (when AVCC<2.7V)	2.7V AVCC		AVCC AVCC	V
VCC Maximum ripple or noise (Note 2)			<10%of VCC	%
VCC rise time (0 to 1.8V) (Note 2)			0.1	mS
VCC shut down time (1.8V to 0V) (Note 2)			1	mS
BT_VREG_IN_HV (Note 4)	2.3		3.6	V
BT_VREG_OUT_HV (Note 4)	1.75		1.95	V
BT_VDD_IO (Note 4)	1.2		3.6	V
Operating Temperature Range	-40	-	+85	°C

Recommended Operating Parameters Notes:

- Note 1** Notes on power on. Turn on/off in the following order or at same time.
Turning on: VCC > AVCC > AVRH. Turning off: AVRH > AVCC > VCC.
If not using the ADC convertor, connect AVCC and AVREF=VCC.
1.8V operation is not supported in current smartBASIC runtime engine FW, see Note 4.
- Note 2** The maximum VCC ripple or noise (at any frequency) should not exceed 10% of VCC. Ensure transient fluctuation rate does not exceed 0.1V/uS.
- Note 3** nRESET input time is minimum 500nS. Customer must fit an external pull-up resistor (10K) on nRESET (pin 16) to VCC for BT900 to be out of reset. BT900 module start-up time is ~1.6 seconds; start-up time is the time taken from power-up to being able to run a smart BASIC command. Most of this is for radio initialisation. 1.6 seconds is also the time when coming out of reset through AT command (atz) or AT command for factory default (at&f*).
- Note 4** The Bluetooth chip in the BT900 has two internal regulators, a high voltage (input pin BT_VREG_IN_HV) and low voltage (input pin BT_VREG_OUT_HV) regulator. ONLY ONE regulator MUST be used to power the radio chip.
- **Method 1:** If the BT900 is required to operate from 3.3V, connect the external 3.3V supply (2.8V-3.6V) to pin 31 (BT_VREG_IN_HV), pin 5 (VCC), and pin 43 (BT_VDD_IO). Customer **MUST** leave pin 32 (BT_VREG_OUT_HV) unconnected.
 - **Method 2:** If the BT900 is required to operate from 1.8V, connect the external 1.8V supply (1.75V-1.95V) to pin 32 (BT_VREG_OUT_HV), pin 5 (VCC) and pin 43 (BT_VDD_IO). Customer **MUST** leave pin 31 (BT_VREG_IN_HV) unconnected.

Note that 1.8V operation is not supported in current smartBASIC runtime engine FW.

Table 5: Signal Levels for Interface, SIO

Parameter	Condition	Min	Typ	Max	Unit
VIH Input high voltage	VCC < 2.7V	0.7VxVCC		VCC+0.3	V
	VCC ≥ 2.7V	0.8VxVCC		VCC+0.3	
VIL Input low voltage	VCC < 2.7V	VSS-0.3		0.3xVCC	V
	VCC ≥ 2.7V			0.2xVCC	V
VOH Output high voltage (std. drive, 4mA) See Note 1	VCC < 2.7V	VCC-0.45		VCC	V
	VCC ≥ 2.7V	VCC-0.5		VCC	V
VOL Output low voltage (std. drive, 4mA)	VCC < 2.7V	VSS		0.4	V
	VCC ≥ 2.7V	VSS		0.4	V
Pull up resistance	VCC < 2.7V	-	-	134	kΩ
	VCC ≥ 2.7V	21	33	66	kΩ
Input capacitance			5	15	pF

Signal Levels for Interface, SDIO Notes:

- Note 1** mA is the total average SIO pin output current which is defined as the average current value flowing through all of the corresponding pins for a 100mS period.

Table 6: SIO pin alternative function AIN (ADC) specification

Parameter	Min	Typ	Max	Unit
AVCC (AVCC = VCC)	1.75	3.3	3.6	V
AVCC current draw (ADC 1 unit operation)		0.27	0.42	mA
AVCC current draw (ADC stop)		0.03	10	uA
AVREF (when AVCC ≥ 2.7V)	2.7 V		AVCC	V
AVREF (when AVCC < 2.7V)	AVCC		AVCC	V
AVREF current draw (ADC 1 unit operation)		0.72	1.29	mA
AVREF current draw (ADC stop)		0.02	2.6	uA
ADC input pin (AIN) voltage maximum	VSS		AVREF	V
ADC input port (AIN) current draw			5	uA
Time required to convert single sample 12 bit mode	2		10	uS
ADC input resistor impedance (during operation) (Note 1)				
AVCC ≥ 2.7V			2.2	kOhm
1.8V ≥ AVCC < 2.7V			5.5-10.5	kOhm
ADC input capacitance impedance (during operation) ¹			9.4	pF

SIO Pin Alternative Function AIN (ADC) Specification Notes:

Note 1 | ADC input impedance is estimated mean impedance of the ADC (AIN) pins. The ADC is highly sensitive to the impedance of the source. The ADC (AIN) input impedance is 2.2-10.5k. Normally, when not sampling, the ADC (AIN) impedance will have very high value and can be considered an open circuit. The moment ADC is sampling, ADC(AIN) impedance is 2.2-10.5k.

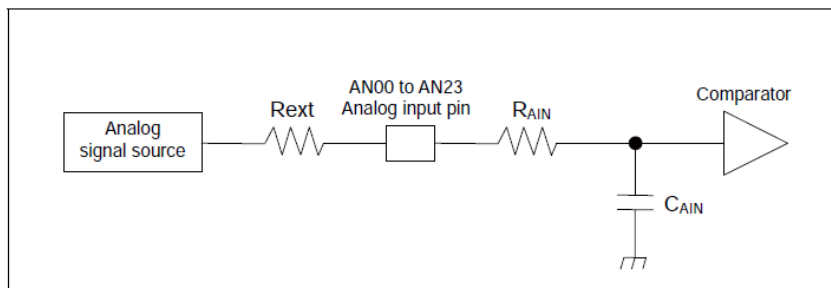

Figure 3: ADC Diagram

R_{ext}: Output impedance of external circuit (kOhms)

R_{ext}: Sampling time (nS)

$$T_s \geq (R_{AIN} + R_{ext}) \times C_{AIN} \times 9$$

R_{AIN} : Input resistor of ADC(kOhms)=2.2kOhms at $2.7V \leq AVCC \leq 3.6V$
 Input resistor of ADC(kOhms)=5.5kOhms at $1.8V \leq AVCC \leq 2.7V$

C_{AIN} : Input capacity of ADC(pF)=9.4pF at $.8V \leq AVCC \leq 3.6V$

You **must** fit an external series resistor (R_{ext}) when using ADC pins, whose value is selected to get required Sample Time (T_s). 1K to 10K may be suitable.

Table 7: Digital I/O characteristics (ONLY those BT900 IO pins with names beginning with “BT_”)

Normal Operation	Min	Typ	Max	Unit
Input Voltage				
VIL input logic level low	-0.4	-	0.4	V
VIH input logic level high	$0.7 \times BT_VDD_IO$	-	$BT_VDD_IO + 0.4$	V
Output Voltage				
VOL output logic level low, IOL = 4.0 mA	-	-	0.4	V
VOH output logic level high, IOL = 4.0 mA	$0.75 \times BT_VDD_IO$	-	-	V
Input and Tristate Currents				
Strong pull-up	-150	-40	-10	μA
Strong pull-down	10	40	150	μA
Weak pull-up	-5	-1.0	-0.33	μA
Weak pull-down	0.33	1.0	5.0	μA
CI input capacitance	1.0	-	5.0	pF

This table applies to those BT900 pins ONLY with names beginning with **BT_**:

- BT_Ext_DS_CLK (pin 34)
- BT_NC (pin 35)
- BT_NC (pin 36)
- BT_NC (pin 37)
- BT_NC (pin 38)
- BT_ACTIVE (pin 39)
- WLAN_ACTIVE (pin 40)
- BT_#SEL (pin 41)
- BT_PRIORITY (pin 42)

Note: BT900 IO pins with names beginning with **BT_** internal pull-up and pull-down resistors are not user-configurable via the *smartBASIC* application.

3.3.3. nAutoRUN Pin and Operating Modes

Operating modes (refer to the *smartBASIC* manual for details):

- Self-contained mode
- Interactive / Development mode

Table 7: nAutoRUN pin

Signal Name	Pin No	I/O	Comments
nAutoRUN	3	I	Input with active low logic. Operating mode selected by nAutoRun pin status: If Low (0V), runs \$autorun\$ if it exists; If High (VCC), runs via at+run (and “file name” of application).

Pin 3 (nAutoRUN) is an input, with active low logic. In the development board (DVK-BT900-sx) it is connected so that the state is driven by the host's DTR output line. nAutoRUN pin needs to be externally held high or low to select between the two BT900 operating modes:

- Self-contained Run mode (nAutoRUN pin held at 0V).
- Interactive / Development mode (nAutoRUN pin held at VCC)

The *smartBASIC* runtime engine firmware checks for the status of nAutoRUN during power-up or reset. If it is low and if there is a *smartBASIC* application named \$autorun\$ then the *smartBASIC* runtime engine executes the application automatically; hence the name *self-contained run mode*.

3.3.4. OTA (Over the Air) *smartBASIC* application download

It is possible to download smart BASIC applications Over the Air (OTA) to the BT900. To enable this, SIO_19 must be pulled low to GND externally (on power up). OTA *smartBASIC* download is possible from a remote host when in vSP command mode only.

The OTA *smartBASIC* application download is useful because it allows the module to be soldered into an end product without pre-configuration; the application can then be downloaded over the air once the product has been pre-tested. It is the *smartBASIC* application that is downloaded over the air and NOT the firmware. Since this is primarily meant for production environments with multiple collocated programming stations, the transmit power is limited.

Table 8: VSP pin description

Signal Name	Pin No	I/O	Comments
SIO_19	22	I	Internal pull up (default). Enter VSP Command mode by externally pulling SIO_19 pin to GND at power-up. OTA functionality is enabled through VSP Command mode.

4 POWER CONSUMPTION

The BT900 module has User configurable clocking (40 MHz, 20 MHz, 4 MHz), so user can reduce current consumption at expense of speed. The default is 40MHz. Please note that when using the 4MHz clock, the maximum supported board rate is 115200. This data was taken at VCC 3.3V and a temperature of 25°C.

4.1. Power Consumption across Clock Frequencies

Table 9: Power consumption at 40MHz, 20MHz, and 4 MHz

Parameter	At 40 MHz	At 20 MHz	At 4 MHz	Unit
	Typical	Typical	Typical	
Active Peak current (Note 1)				
TX only run peak current @TX power = +8 dBm	85	85	85	mA
TX only run peak current @TX power = +4 dBm	71	71	71	mA
TX only run peak current @TX power = 0 dBm	61	61	61	mA
TX only run peak current @TX power = -4 dBm	55	55	55	mA
TX only run peak current @TX power = -8 dBm	52	52	52	mA
TX only run peak current @TX power = -12 dBm	49	49	49	mA
TX only run peak current @TX power = -16 dBm	48	48	48	mA
TX only run peak current @TX power = -20 dBm	48	48	48	mA
RX only 'peak' current	TBD	TBD	TBD	
Low Power Mode 1				
Standby Doze (waitevent) (Note 2)	10.7	6.9	2.8	mA

Parameter	At 40 MHz	At 20 MHz	At 4 MHz	Unit
	Typical	Typical	Typical	
Low Power Mode 2 (Note 3)				
Deep Sleep (Note 3)	2.7	2.7	2.7	uA
Classic BT Mode (Note 5)				
Inquiring Mode (AT+BTI)	23.9	19.5	6.4 (Note 6)	mA
Wait for Connection or Discoverable	33	30	25 (Note 6)	mA
BT900 Master Role (connection ACL) (Note 5)				
Connecting Mode (ATDxxx)	37.8	29.8	27 (Note 6)	mA
Connected Mode (No Data Transfer)	20.5	16.3	12.6 (Note 6)	mA
Connected Mode (Max Data Transfer)	31	19	12.9 (Note 6)	mA
BT900 Slave Role (connection ACL) (Note 5)				
Connecting Mode (ATDxxx)	42	38.5	32.6	mA
Connected Mode (No Data Transfer)	35.3	30.7	22.7 (Note 6)	mA
Connected Mode (Max Data Transfer)	30.4	22.6	11.2	mA
Inquiring (Note 5)				
Scan interval: 640 ms, Scan Window: 320 ms	18	18	Note 6	mA
Scan interval 1920 ms, Scan Window 960 ms	18	11		mA
BLE Mode				
Active Mode Average Current (Note 4)				
Advertising Average Current Draw				
Maximum with advertising interval (min) 20 ms	23.3	12.5	9.8	mA
Minimum with advertising interval (max) 10240 ms	10.6	6.7	2.5	mA
Connection Average Current Draw				
Maximum with connection interval (min) 8 ms	17.2	12.4	9.3	mA
with connection interval 68 ms	11.4	7.4	3.2	mA
Minimum with connection interval (max) 4000 ms	10.6	6.7	2.5	mA
Scanning (Note 5)				
Active Scan Interval = 80 ms Scan Window = 40 ms	40	34	28	mA

Power Consumption Notes:

Note 1 Peak current is the current seen only during the duration of radio activity burst where TX is on and transmit power in Table 9 is transmitted.

Power Consumption Notes:

- Note 2** Standby Doze is entered automatically (when a *waitevent* statement is encountered within a *smartBASIC* application script). In Standby Doze, all enabled peripherals remain on and may re-awaken the chip. The module wakes up from Standby Doze via an interrupt (such as a received character on the UART Rx line). The module wakes up every millisecond to service the interrupt. If the module receives a UART character from either the external UART or the radio, it wakes up.
- Note 3** In Deep Sleep, everything is disabled and the only wake-up sources are reset and changed on pins on which sense is enabled. The current typical consumption is 2.7uA.
smartBASIC runtime engine firmware requires a hardware reset to come out of deep sleep. Firmware allows the module to transition from Deep Sleep to Standby Doze through GPIO signals through the reset vector. Enter Deep Sleep mode via a command in your *smartBASIC* application script.
- Note 4** The BLE radio taken with a TX power of 8 dBm and all peripherals off (UART OFF after radio event), slave latency of 0 (in a connection).
Average current consumption depends on a number of factors including a TX power and VCC accuracy of 26 MHz and 32.768 kHz. With these factors fixed, the largest variable is the advertising or connection interval set. Factors include:
- **Advertising Interval range:**
 - 20 ms to 10240 ms in multiples of 0.625 ms for Advert type=ADV_IND and ADV_DIRECT_IND
 - 100 ms to 10240 ms in multiples of 0.625 ms for Advert type=ADV_SCAN_IND and ADV_NONCONN_IND
 - For advertising timeout, if the advert type is ADV_DIRECT_IND, the timeout is limited to 1.28 seconds (1280 ms).

For an advertising event...

 - The minimum average current consumption is when the advertising interval is large 10240 mS (this may cause long discover times for the advertising event by scanners.
 - The maximum average current consumption is when the advertising interval is small (around 20 ms).
 - Other factors that are also related to average current consumption include the advertising payload bytes in each advertising packet, as well as whether the BT900 is continuously advertising or periodically advertising.
 - **Connection Interval range:**
 - 7.5 ms to 4000 ms in multiples of 1.25 ms.

For a connection event...

 - The minimum average current consumption is when the connection interval is large (around 4000 ms)
 - The maximum average current consumption is with the shortest connection interval of 7.5 ms; no slave latency.
- Other factors related to average current consumption include whether transmitting 6 packets per connection interval and if each packet contains 20 bytes (which is the maximum for each packet). An inaccurate 32 kHz master clock accuracy would increase the average current consumption.
- Note 5** Average current measurement using a current shunt IC (on DVK-BT900) and an oscilloscope.
- Note 6** At 4 MHz clocking, slower throughput.

5 FUNCTIONAL DESCRIPTION

The BT900 dual mode (BT/BLE) module is a self-contained Bluetooth Low Energy product and requires only power and a user's *smartBASIC* application to implement full BLE functionality. The integrated, high performance antenna combined with the RF and base-band circuitry provides the Bluetooth Low Energy wireless link, and any of the SIO lines provide the OEM's chosen interface connection to the sensors. The user's *smartBASIC* application binds the sensors to the BLE wireless functionality.

The variety of hardware interfaces and the *smartBASIC* programming language allow the BT900 module to serve a wide range of wireless applications, while reducing overall time to market and the learning curve for developing dual-mode BT/ BLE products.

To provide the widest scope for integration, a variety of physical host interfaces/sensors are provided. The major BT900 series module functional blocks described below.

5.1. Power Management (includes brown-out and power-on-reset)

Power management features:

- System Standby Doze/Deep Sleep modes.
- Brownout Reset
- Open/Close peripherals (UART, SPI, I2C, SIO's and ADC) with a command in a *smartBASIC* application script
- Pin wake-up system from Deep sleep

Power supply features:

- Supervisor HW to manage power on reset, brownout (and power fail).
- 1.8V to 3.6V operating supply range. 1.8V operation is not supported in current *smartBASIC* runtime engine FW.

5.2. Clocks and Timers

5.2.1. Clocks

The integrated high accuracy (+/-20 ppm) 32.768 kHz crystal oscillator provides protocol timing and helps with radio power consumption in the system Standby Doze/Deep sleep modes by reducing the time that the RX window must be open. Standard accuracy clocks tend to have lower accuracy +/-250 ppm.

The integrated high accuracy 26 MHz (+/-10 ppm) crystal oscillator helps with Radio operation and also helps reduce power consumption in the Active modes.

5.2.2. Timers

In keeping with the event driven paradigm of *smartBASIC*, the timer subsystem enables the writing of *smartBASIC* which allows the generation of future events based on timeouts.

- Regular Timer – There are eight built-in timers (regular timer) derived from a single multifunction timer clock which are controlled solely by *smartBASIC* functions. The resolution of the regular timer is dependent on the selected system clock frequency can be obtained from [Table 10](#).

Table 10: System Clock and Tick Count Period

System Clock (MHz)	Tick Count Period (uS)
40	6.4
20	12.8
4	64

- Tick Timer – This is a 31-bit free running counter that increments every one millisecond. The resolution of this counter is dependent on the selected system clock frequency and can be obtained from [Table 10](#).

Refer to the *smartBASIC* user guide for more information.

5.3. Memory for *smart*BASIC Application Code and Data

Up to approximately 48 Kb of data memory is available for the *smart*BASIC application script and up to 4 Kb is available for data.

5.4. RF

- 2402–2480 MHz Bluetooth 4.0 Dual Mode (BT and BLE); 1 Mbps to 3 Mbps over the air data rate.
- TX output power of +8 dBm programmable (via *smart*BASIC command) to -20 dBm in steps of four dB.
- Receiver (with integrated channel filters) to achieve maximum sensitivity -90 dBm @ 1 Mbps BLE or Classic BT, 2 Mbps, 3 Mbps).
- RF conducted interface available in 2-ways:
 - BT900-SA: RF connected to on-board antenna on the BT900-SA
 - BT900-SC: RF connected to on-board uFL RF connector on the BT900-SC
- Antenna options:
 - Integrated monopole chip antenna on the BT900-SA
 - External dipole antenna connected with to uFL RF connector on the BT900-SC.

5.5. UART Interface

The Universal Asynchronous Receiver/Transmitter (UART) offers fast, full-duplex, asynchronous serial communication with built-in flow control support (UART_CTS, UART_RTS) in hardware up to 2 Mbps baud. No parity checking, 8 data bits, and 1 stop bit are supported.

UART_TX, UART_RX, UART_RTS, and UART_CTS form a conventional asynchronous serial data port with handshaking. The interface is designed to operate correctly when connected to other UART devices such as the 16550A. The signalling levels are nominal 0 V and 3.3 V (tracks VCC) and are inverted with respect to the signalling on an RS232 cable.

Two-way hardware flow control is implemented by UART_RTS and UART_CTS. UART_RTS is an output and UART_CTS is an input. Both are active low.

These signals operate according to normal industry convention. UART_RX, UART_TX, UART_CTS, and UART_RTS are 3.3 V level logic (tracks VCC). For example, when RX and TX are idle they sit at 3.3 V. Conversely for handshaking pins CTS, RTS at 0 V is treated as an assertion.

The module communicates with the customer application using the following signals:

- Port/TXD of the application sends data to the module's UART_RX signal line
- Port/RXD of the application receives data from the module's UART_TX signal line

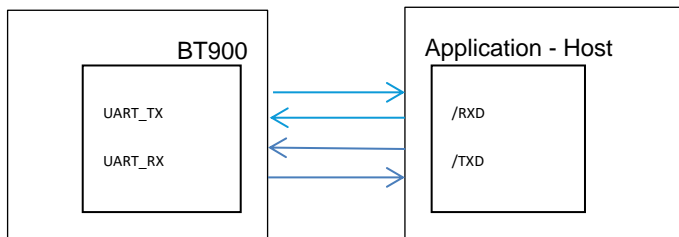

Note: The BT900 serial module output is at 3.3V CMOS logic levels (tracks VCC). Level conversion must be added to interface with an RS-232 level compliant interface.

Some serial implementations link CTS and RTS to remove the need for handshaking. We do not recommend linking CTS and RTS except for testing and prototyping. If these pins are linked and the host sends data when the BT900 deasserts its RTS signal, there is significant risk that internal receive buffers will overflow, which could lead to an internal processor crash. This drops the connection and may require a power cycle to reset the module. We recommend that you adhere to the correct CTS/RTS handshaking protocol for proper operation.

Table 11: UART Interface

Signal Name	Pin No	I/O	Comments
SIO_1 / UART_TX	45	O	SIO_1 (alternative function UART_TX) – Output, set high (in FW).
SIO_0 / UART_RX	44	I	SIO_0 (alternative function UART_RX) – Input, set with internal pull-up (in FW).
SIO_2 / UART_RTS	46	O	SIO_2 (alternative function UART_RTS) – Output, set low (in FW).
SIO_3 / UART_CTS	1	I	SIO_3 (alternative function UART_CTS) – Input, set with internal pull-up (in FW).

The UART interface is also used to load customer developed *smart*BASIC application script.

UART has a deep buffer (UART_RX deep buffer) of 1024 bytes.

5.6. SPI Bus

The SPI interface is an alternate function on SIO pins, configurable by *smart*BASIC.

The module is a master device that uses terminals SPI_MOSI, SPI_MISO, and SPI_CLK. SPI_CS is implemented using any spare SIO digital output pins to allow for multi-dropping. On DVK-BT900 devboard, SIO_8 is used at the SPI_CS.

The SPI interface enables full duplex synchronous communication between devices. It supports a 3-wire (SPI_MOSI, SPI_MISO, SPI_SCK,) bi-directional bus with fast data transfers to and from multiple slaves. Individual chip select signals are necessary for each of the slave devices attached to a bus, but control of these is left to the application through use of SIO signals. I/O data is double buffered.

The SPI peripheral supports SPI mode 0, 1, 2, and 3.

Table 12: Peripheral supports

Signal Name	Pin No	I/O	Comments
SPI_MOSI	8	O	This interface is an alternate function configurable by <i>smart</i> BASIC. Default in the FW pin 8 and 10 are inputs. SPIOPEN() in smart BASIC selects SPI function and changes pin 8 and 10 to outputs (when in SPI master mode).
SPI_MISO	7	I	
SPI_CLK	10	O	SPI_CS is implemented using any spare SIO digital output pins to allow for multi-dropping. On DVK-BT900 devboard, SIO_8 (pin9) is used at the SPI_CS.

5.7. I2C Interface

The I2C interface is an alternate function on SIO pins, configurable by *smart*BASIC command.

The two-wire interface can interface a bi-directional wired-OR bus with two lines (SCL, SDA) and has master/slave topology. The interface is capable of clock stretching. Data rates of 100 kbps and 400 kbps are supported.

An I2C interface allows multiple masters and slaves to communicate over a shared wired-OR type bus consisting of two lines which normally sit at VCC. The BT900 module can only be configured as an I2C master and can be the **only** master on the bus. The SCL is the clock line which is always sourced by the master; the SDA is a bi-directional data line which can be driven by any device on the bus.

IMPORTANT: It is essential to remember that pull-up resistors on both SCL and SDA lines are not provided in the module and MUST be provided external to the module.

Table 13: I2C Interface

Signal Name	Pin #	I/O	Comments
I2C_SDA	11	I/O	This interface is an alternate function on each pin, configurable by <i>smartBASIC</i> . I2COPEN() in <i>smartBASIC</i> selects I2C function.
I2C_SCL	12	I/O	

5.8. General Purpose I/O, ADC, PWM/FREQ and Host-wakeup

5.8.1. GPIO

The 18 SIO pins are configurable by *smartBASIC* and can be accessed individually. Each has the following user configured features:

- Input/output direction (output drive strength – 4mA).
- For inputs, Internal pull up resistors (33K typical) or no pull-up.

5.8.2. ADC

The ADC is an alternate function on SIO pins and is configurable by *smartBASIC*.

The BT900 provides access to 2-channel 12-bit incremental ADC. This enables sampling multiple external signals through a front end MUX. The ADC has configurable input.

Note: Current *smartBASIC* runtime engine firmware provides access to 12-bit mode resolution.

1.1.1.1 Analog Interface (ADC)

Table 14: Analog interface

Signal Name	Pin #	I/O	Comments
AIN – Analog Input	24	I	This interface is an alternate function on each pin, configurable by <i>smartBASIC</i> . AIN configuration selected using GpioSetFunc() function. 12 bit resolution.
AIN – Analog Input	25	I	

1.1.2 PWM and FREQ signal output on up to two SIO pins

The PWM and FREQ output is an alternate function on SIO pins and is configurable by *smartBASIC*.

The ability to output a PWM (Pulse Width Modulated) signal or FREQ output signal on up to three GPIO (SIO) output pins available via *smartBASIC* runtime engine firmware and can be selected using the *smartBASIC* command GpioSetFunc().

PWM output signal has a frequency and duty cycle property. PWM output is generated using 32-bit hardware timers. The timers are clocked by a 4 MHz clock source. Frequency is adjustable (up to 1 MHz) and the Duty cycle can be set over range from 0% to 100% (both configurable by *smartBASIC* command).

Note: The frequency driving the two SIO pins is the same but the duty cycle can be independently set for each pin.

FREQ output signal frequency can be set over a range of 0 Hz to 4 MHz (with 50% mark-space ratio).

5.9. nRESET pin

Table 15: nRESET pin

Signal Name	Pin No	I/O	Comments
nRESET	16	I	BT900 HW reset (active low). Pull the nRESET pin low for minimum 500 nS in order for the BT900 to reset. By default, the module is out of reset (internal weak-pull-up, 33k) when power is applied to the VCC pin

Note: For robustness against external interference, you MUST fit an external pull-up resistor (10K) on nRESET (pin 16) to VCC for the BT900 to be out of reset. nRESET needs to be held low (0V) for greater than 500 nS to reset the module.

5.10. nAutoRUN pin

Refer to section [nAutoRUN pin and Operating Modes](#) regarding operating modes and the nAutoRUN pin.

- Self-contained Run mode
- Interactive/Development mode

5.11. smartBASIC Runtime Engine Firmware Upgrade

The BT900 software consists of the following:

- BT900 smartBASIC runtime engine firmware (loaded at production, may be upgraded by the customer).
- BT900 smartBASIC application script developed by customer (loaded through UART by the customer).

To allow customer the capability to upgrade the BT900 smartBASIC runtime engine FW to the latest version released from Laird, the current smartBASIC runtime engine firmware only allows this upgrade via the UART.

5.12. Wake-up BT900

5.12.1. Waking up BT900 from Host

Wake-up the BT900 from the host using wake-up pins (UART_CTS, UART_RX, SIO_20 (ADC01)). Refer to the smartBASIC user manual for details. You may configure the BT900's wakeup pins via smartBASIC to:

- Wake up when signal is low
- Wake up when signal is high
- Wake up when signal changes

BT900 also has pins that are external interrupts; refer to the smartBASIC user manual for details.

5.12.2. Wake up Host from BT900

This may be done by use of the BT900 SIO pin. Refer to the smartBASIC user manual for details.

5.13. Low Power Modes

The BT900 has three power modes: Run, Standby Doze and Deep Sleep. Further, the BT900 has user configurable clocking (40MHz, 20MHz, 4MHz) allowing power consumption trade-off in Run and Standby Doze modes.

The module is placed automatically in Standby Doze if there are no events pending (when *waitevent* statement is encountered within a customer's smartBASIC script). The module will wake up from Standby Doze via an interrupt e.g. received character on the UART Rx line. The module wakes up every millisecond to service the interrupt. If the module receives a UART character from either the external UART or the radio, that will cause it to wake up.

Deep sleep is the lowest power mode. Once awakened, the system will go through a system reset.

5.14. BT and Wi-Fi Coexistence

The BT900 supports the following CSR BT-WiFi coexistence schemes:

- Unity-3 (for use with Classic BT)
- Unity-3e (for use with BLE)

Refer to the *smartBASIC* user manual for details.

5.15. BLE vSP modes

This section discusses VSP Command mode through pulling SIO_19 low and nAutoRUN low externally. Read this section in conjunction with the *VSP Configuration* chapter of the BT900 *smartBASIC* Extensions guide which is available from the Documentation tab of [BT900 product page](#) of the Laird website.

Figure 4 shows the difference between VSP Bridge-to-UART mode and VSP Command mode and how SIO_19 and nAutoRUN must be configured to select between these two modes.

- **VSP Bridge-to-UART mode** – Sends data (sent from a phone or tablet over BLE) to the BT900 to be sent out of the BT900 UART (therefore data is not stored on the BT900).
- **VSP Command mode** – Sends data (sent from phone or tablet) to the BT900 and stores that data in the BT900. The OTA Android or iOS application can be used to download any *smartBASIC* application script over the air to the BT900.

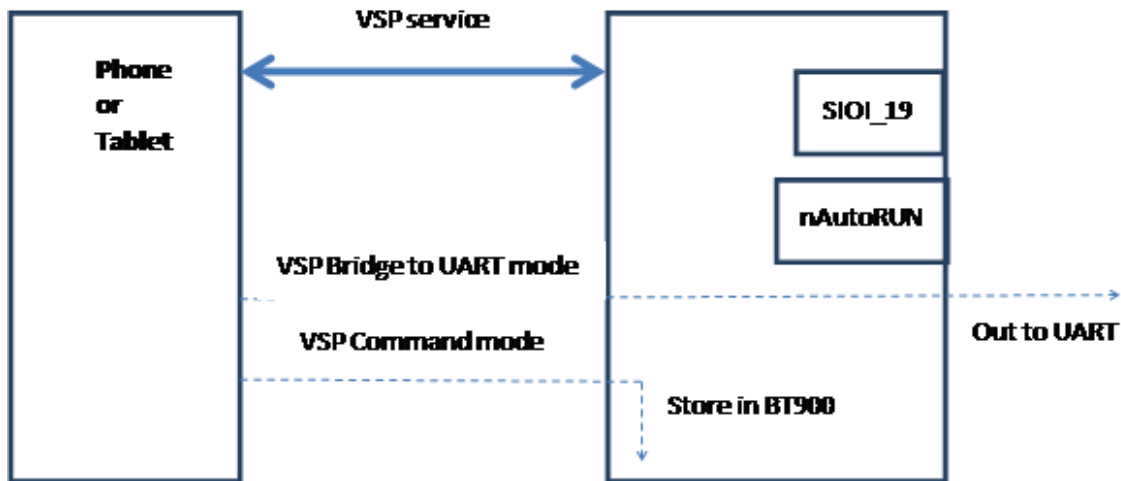

Figure 4: Difference between VSP Bridge-to-UART mode and VSP Command mode

Table 16: vSP modes

Mode	SIO_19 pin	nAutoRUN pin
VSP Bridge-to-UART Mode	Externally held LOW	Externally held HIGH
VSP Command Mode	Externally held LOW	Externally held LOW

SIO_19 Low (externally) selects the VSP service and together, when nAutoRUN is Low (externally), selects VSP Command mode whilst nAutoRUN High (externally) selects VSP Bridge to UART mode.

When SIO_19 on module is set low (externally), VSP is enabled and auto-bridged to UART when connected. However, for VSP Command mode, auto-bridge to UART is not required. With SIO_19 set to Low and nAutoRUN set to Low, VSP Command mode is entered and you can then download the *smartBASIC* application onto the module over-the-air from the phone (or tablet).

5.16. BT900-SA On-board Chip Antenna Characteristics

The BT900-SA on-board chip monopole antenna's radiated performance depends on the host PCB layout.

The BT900 development board was used for BT900 development and antenna performance evaluation. To obtain similar performance, follow the guidelines in the [PCB Layout on Host PCB for BT900-SA](#) section to allow the on-board antenna to radiate and reduce proximity effects due to nearby host PCB GND copper or metal covers.

BT900-SA on-board antenna datasheet is available here:

http://www.acxc.com.tw/product/at/at3216/AT3216-B2R7HAA_S-R00-N198_2.pdf

Antenna performance on DVK-BT900-V01 development board is shown below.

Far-field Power Distribution(H+V) on X-Y Plane

Plot Peak Gain(H+V)=-2.6 dB; Plot AvgGain(H+V)=-7.4dB @2.44000 GHz

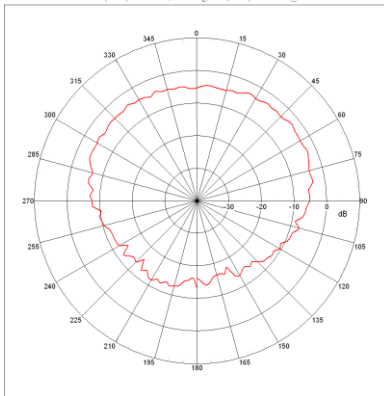

	Peak Gain	Avg. Gain
XY-plane	-2.6	-7.4

Far-field Power Distribution(H+V) on X-Z Plane

Plot Peak Gain(H+V)=-2.8 dB; Plot AvgGain(H+V)=-5.9dB @2.44000 GHz

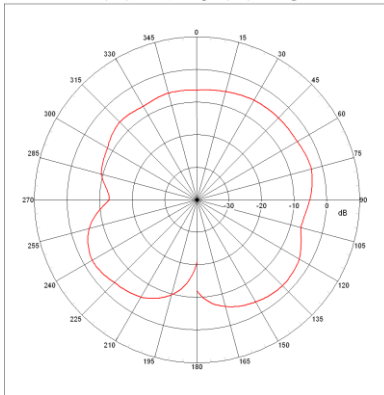

	Peak Gain	Avg. Gain
XZ-plane	-2.8	-5.9

Far-field Power Distribution(H+V) on Y-Z Plane

Plot Peak Gain(H+V)=-1.6 dB; Plot AvgGain(H+V)=-4.7dB @2.44000 GHz

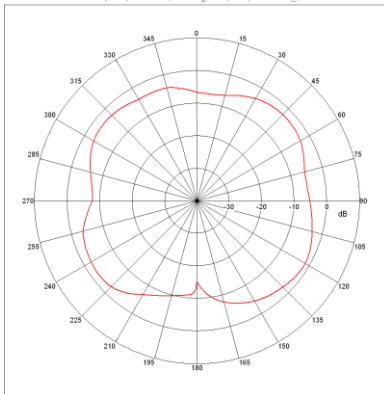

	Peak Gain	Avg. Gain
YZ-plane	-1.6	-4.7

6 HARDWARE INTEGRATION SUGGESTIONS

6.1. Circuit

The BT900-series module is easy to integrate and requires few external components on your board aside from what is required for development and in the end application.

Checklist (for schematic):

- **VCC**
External power source within the operating range, rise time, and noise/ripple specification of BT900. Add decoupling capacitors for filtering the external source. The power-on reset circuitry within BT900 series module incorporates brown-out detector, which simplifies the power supply design. Upon application of power, the internal power-on reset ensures that the module starts correctly. You may add a bulk capacitor (if required) to smooth out any noise that may be present on the VCC supply due to BT900 activity.
- **Decide if BT900 is to be powered by 3.3V or 1.8V external Power Supply**
The BT radio chip in the BT900 has two internal regulators, a high voltage (input pin BT_VREG_IN_HV) and a low voltage (input pin BT_VREG_OUT_HV). ONLY one regulator can be used to power radio chip.
 - **Method 1:** If the BT900 is required to operate from 3.3V, connect the external 3.3V supply (2.8V-3.6V) to pin 31 BT_VREG_IN_HV, pin 5 (VCC), and pin 43 (BT_VDD_IO). Customer **MUST** leave pin 32 BT_VREG_OUT_HV UNCONNECTED.
 - **Method 2:** If the BT900 is required to operate from 1.8V, connect the external 1.8V (1.75V-1.95V) supply to pin 32 BT_VREG_OUT_HV, Pin 5 (VCC), and pin 43 (BT_VDD_IO). Customer **MUST** leave pin 31 BT_VREG_IN_HV UNCONNECTED.

Note: 1.8V operation is not supported in the current *smart*BASIC runtime engine FW. You must operate the BT900 from nominal 3.3V supply (2.8V-3.6V).

- **Place decoupling capacitor 0.1 uF on pin 43 (BT_VDD_IO) to GND**
Value 0.1uF or value suitable to filter the noise present.
- **VCC Turn on/off in the following order or preferably at the same time**
Turning on: VCC (BT_VREG_IN_HV, BT_VDD_IO) > AVCC > AVRH.
Turning off: AVRH > AVCC > VCC (BT_VREG_IN_HV, BT_VDD_IO).
If not using the ADC convertor, connect AVCC and AVREF = VCC.
- **You must connect a 100 K pull-down resistor on BT_#SEL externally to GND**
- **AIN (ADC) and SIO pin IO voltage levels**
BT900 SIO voltage levels are at VCC. Ensure that input voltage levels into SIO pins are also at VCC. (if VCC source is a battery whose voltage will drop). Ensure that the ADC pin maximum input voltage for damage is not violated.
- **Filter the external supply that is being connected to BT900 AVCC and AVREF pins.**
Filter depends on the noise present on your external supply. See the DVK-BT900-V01 schematic.
- **UART**
Required for loading your *smart*BASIC application script during development (or for subsequent upgrades). Add connector to allow UART to be interfaced to PC (via UART-RS232 or UART-USB).
- **UART_RX and UART_CTS**
SIO_0 (alternative function UART_RX) is an input, set with internal pull-up (in FW). The pull-up prevents the module from going into deep sleep when UART_RX line is idling.
SIO_3 (alternative function UART_CTS) is an input, set with external pull-down. This pull-down ensures that the default state of the UART_CTS is asserted; this means it can send data out of the UART_TX line (in the case when UART_CTS is not connected, which we do not recommend).
- **nAutoRUN pin and operating mode selection**
The nAutoRUN pin must be externally held high or low to select between the two BT900 operating modes at power-up:
 - Self-contained Run mode (nAutoRUN pin held at 0V).
 - Interactive/development mode (nAutoRUN pin held at VCC).Make provisions to allow operation in the required mode. Add a jumper to allow nAutoRUN pin to be held high or low (via 10K resistor) or driven by host GPIO.

- **I2C**
IMPORTANT: Pull-up resistors on both I2C_SCL and I2C_SDA lines are not provided in the BT900 module and **MUST** be provided externally to the module as per I2C standard.
- **SPI**
Implement SPI chip select using any unused SIO pin within your *smartBASIC* application script to control SPI_CS from the *smartBASIC* application to allow multi-dropping.
- **SIO pin direction**
For BT900 modules shipped from production with *smartBASIC* runtime engine firmware, most SIO pins (with a default function of DIO) are digital inputs (see [Table 2](#)). Remember to change the direction SIO pin (in your *smartBASIC* application script) if that particular pin is wired to a device that expects to be driven by the BT900 SIO pin configured as an output. Also, SIO pins that are inputs are set in firmware by default to have internal pull-up resistor enabled (on SIO_xx pins, not BT_xxxx pins). You may configure this in your *smartBASIC* application script.

Note: The internal pull-up takes current from VCC.

- **SIO_19 pin and VSP Command**
SIO_19 pin must be pulled to GND externally to enable VSP (virtual serial Port) Command mode for BLE. SIO_19 is an input, set with internal pull-up in the firmware. VSP Command mode is used to load *smartBASIC* scripts OTA (over the air) from a BLE-enabled host.
- **nRESET pin (active low)**
Hardware reset. Wire out to push button or drive by host.
By default, the module is out of reset (internal weak-pull-up, 33k) when power is applied to the VCC pin.
For robustness against external interference, you **MUST** fit an external pull-up resistor (10K) on nRESET (pin 16) to VCC for the BT900 to be out of reset. nRESET needs to be held low (0V) for greater than 500nS to reset the module.

6.2. PCB Layout on Host PCB - General

PCB Checklist

- You **MUST** place the BT900-Sx module close to the edge of PCB (mandatory for BT900-SA for on-board chips antenna to radiate properly).
- Use solid GND plane on the inner layer (for best EMC and RF performance).
- All module GND pins **MUST** be connected to host PCB GND.
- Place GND vias as close to module GND pads as possible.
- Unused PCB area on surface layer can be flooded with copper but place GND vias regularly to connect copper flood to inner GND plane. If GND, flood copper underside the module then connect with GND vias to inner GND plane.
- Route traces to avoid noise being picked up on VCC supply and AIN (analogue) and SIO (digital) traces.
- Do **NOT** run any track near pin 34 of the BT900-Sx.
- Ensure no exposed copper is on the underside of the module (refer to land pattern of BT900 development board).

6.3. PCB Layout on Host PCB for BT900-SA

6.3.1. Antenna Keep-out on Host PCB

The BT900-SA has an integrated chip antenna and its performance is sensitive to host PCB. It is critical to locate the BT900-SA on the edge of the host PCB (or corner) to allow the antenna to radiate properly. Refer to guidelines in section [Host PCB Land Pattern and Antenna Keep-out for BT900-SA](#). Some of those guidelines are repeated below.

- Ensure there is no copper in the antenna keep-out area on any layers of the host PCB. Keep all mounting hardware and metal clear of the area to allow proper antenna radiation.
- For best antenna performance, place the BT900-SA module on the edge of the host PCB, preferably in the corner with the antenna facing the corner.
- The BT900 development board has the BT900-SA module on the edge of the board (not in the corner). The antenna keep-out area is defined by the BT900 development board which was used for module development and antenna performance evaluation is shown in [Figure 5](#), where the antenna keep-out area is ~5.18 mm wide, 31.7 mm long; with PCB dielectric height 0.6 mm sitting under the BT900-SA antenna.

- A different host PCB thickness dielectric will have small effect on antenna.
- The antenna-keep-out defined in Host PCB Land Pattern and Antenna Keep-out for BT900-SA applies when the BT900-SA is placed in the corner of the host PCB. When BT900-SA cannot be placed as such, it must be placed on the edge of the host PCB and the antenna keep out must be observed. An example is shown in [Figure 5](#).

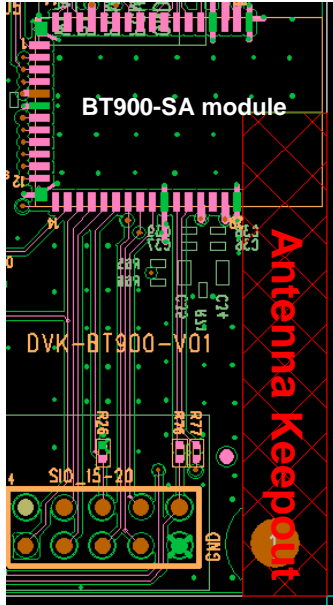

Notes:

- BT900 module placed on edge of host PCB.
- Copper cut-away on all layers in the Antenna Keep-out area under the BT900 on the host PCB.

Figure 5: Antenna keep-out area (shown in red), corner of the BT900 development board for BT900-SA module.

6.3.2. Antenna keep-out and Proximity to Metal or Plastic

Checklist (for metal/plastic enclosure):

- The minimum safe distance for metals without seriously compromising the antenna (tuning) is 40 mm top/bottom and 30 mm left or right.
- Metal in close proximity to the BT900-SA chip monopole antenna (bottom, top, left, right, any direction) will have degradation on the antenna performance. The amount of degradation is system-dependent; some testing will be required in your host application.
- The presence of metal closer than 20 mm starts to significantly degrade performance (S11, gain, radiation efficiency).
- We recommend that you test the range with a product mock-up (or actual prototype) to assess the effects of enclosure height and the applicable material (metal or plastic).

6.4. External Antenna Integration with BT900-SC

Please refer to the regulatory sections for [FCC](#), [IC](#), [CE](#), and [Japan](#) for details of use of BT900-Sx with external antennas in each regulatory region.

The BT900 family has been designed to operate with the external antennas listed below (with a maximum gain of 2.0 dBi). The required antenna impedance is 50 ohms. See [Table 17](#).

External antennas improve radiation efficiency.

Table 17: External antennas for the BT900

External Antenna PN	Mfg.	Type	Gain (dBi)	Connector Type	BT900 PN
S181FL-L-RMM-2450S	Nearson	Dipole	2.0	uFL Note 1	BT900-SC
MAF94045	Laird	PCB Dipole	2.0	uFL Note 1	BT900-SC
MAF94017	Laird	Dipole	2.0	SMA	BT900-SC
MAF94019	Laird	Dipole	1.5	uFL	BT900-SC

7 MECHANICAL DETAILS

7.1. BT900 Mechanical Details

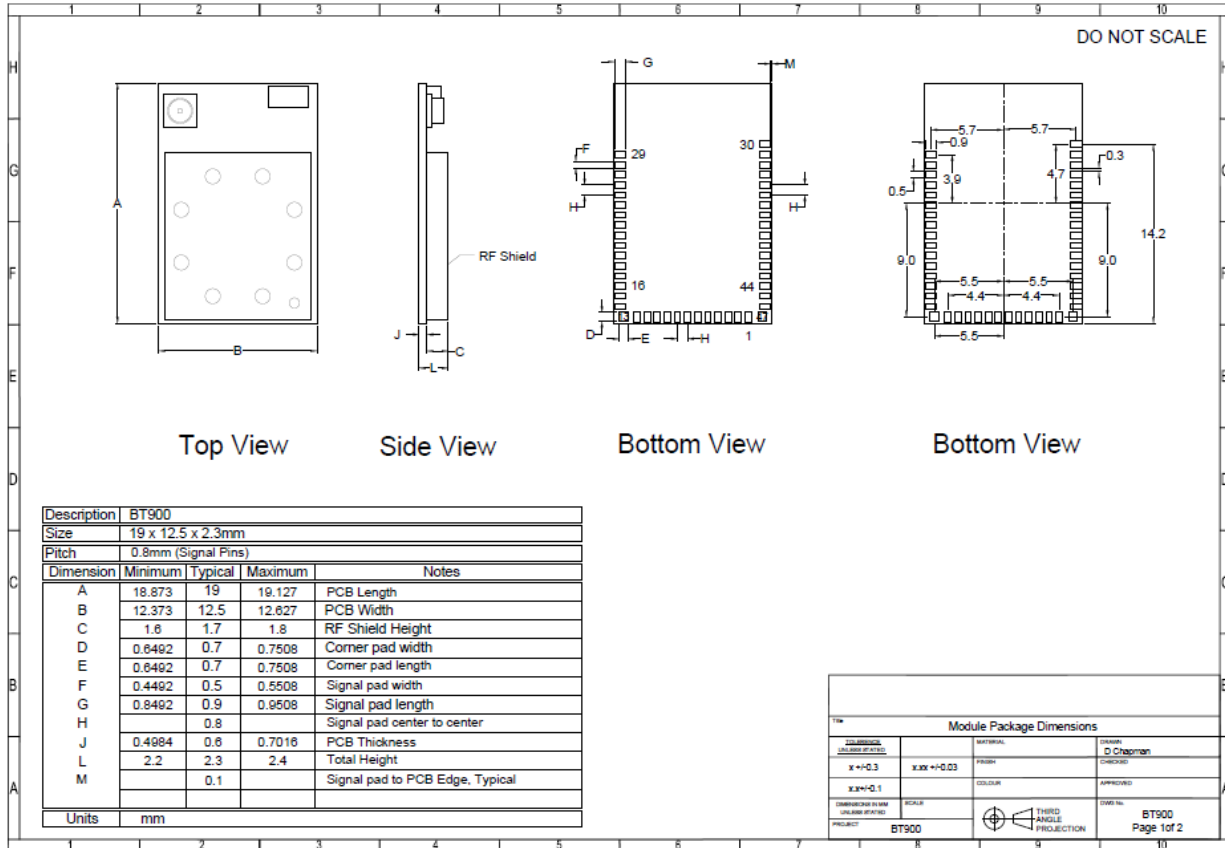

Figure 6: BT900 mechanical drawings

Development Kit Schematics can be found in the documentation tab of the BT900 product page:

<https://connectivity.lairdtech.com/wireless-modules/bluetooth-modules/bluetooth-42-and-40-modules/bt900-series>

7.2. Host PCB Land Pattern and Antenna Keep-out for BT900-SA

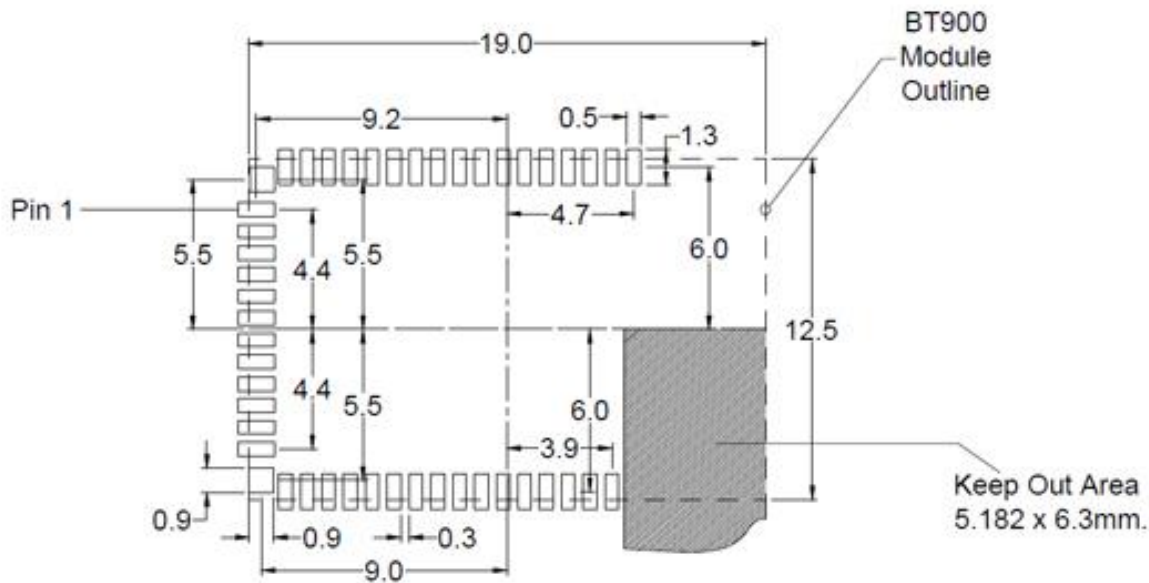

Figure 7: Host PCB - top view

Dimensions in mm.

Host PCB Land Pattern and Antenna Keep-out Notes:

- Note 1** Ensure there is no copper in the antenna Keep Out area on any layers of the host PCB. Also, keep all mounting hardware or any metal clear (Refer to 6.3.2) of the area to reduce effects of proximity detuning the antenna and to help antenna radiate properly.
- Note 2** For BT900-SA (has on-board chip antenna) best antenna performance, the module **must** be placed on the edge of the host PCB and preferably in the corner with the antenna facing the corner (above the Keep Out Area). If the BT900-SA is not placed in the corner but on edge of the host PCB, the antenna Keep Out Area is extended (see **Note 3**).
- Note 3** If the BT900 development board has the BT900-SA placed on the edge of the PCB board (and not in corner), the antenna Keep Out Area is extended down to the corner of the development board (See [PCB Layout on Host PCB for BT900-SA](#)). This was used for module development and antenna performance evaluation.
- Note 4** Ensure that there is no exposed copper under the module on the host PCB.
- Note 5** The user may modify the PCB land pattern dimensions based on their experience and/or process capability.

8 APPLICATION NOTE FOR SURFACE MOUNT MODULES

8.1. Introduction

Laird's surface mount modules are designed to conform to all major manufacturing guidelines. This application note is intended to provide additional guidance beyond the information that is presented in the User Guide. This application note is considered a living document and is updated as new information is presented.

The modules are designed to meet the needs of a number of commercial and industrial applications. They are easy to manufacture and conform to current automated manufacturing processes.

8.2. Shipping

8.2.1. Tray Package

Modules are shipped in ESD (Electrostatic Discharge) safe trays that can be loaded into most manufacturers pick and place machines.

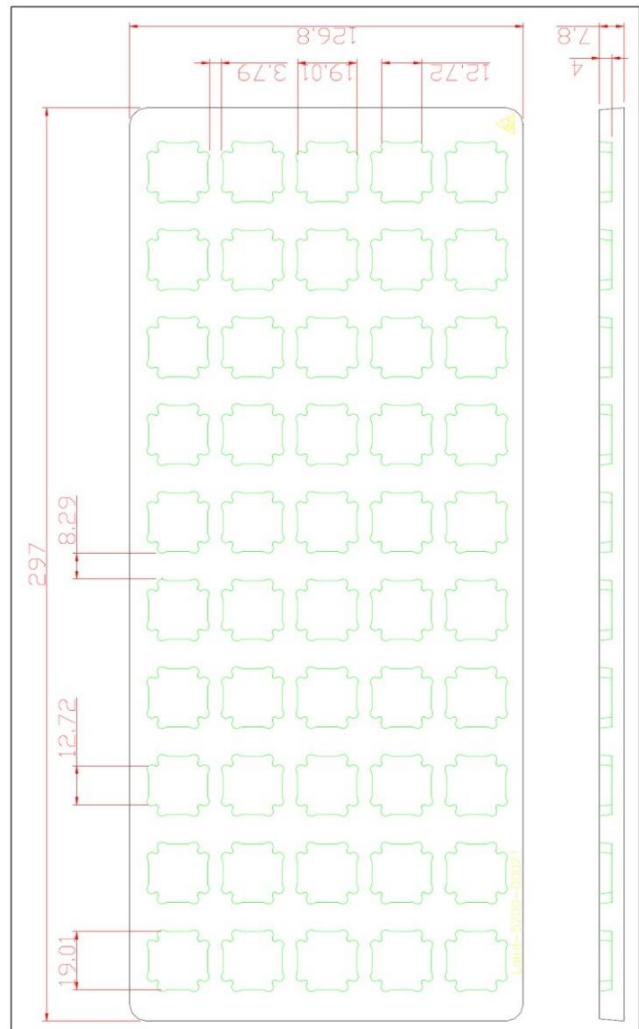

Figure 8: BT900 Shipping Tray Details

8.2.2. Tape and Reel Package Information

Note: Ordering information for Tape and Reel packaging is an addition of T/R to the end of the full module part number. For example, BT900-SC-0x becomes BT900-SC-0x-T/R.

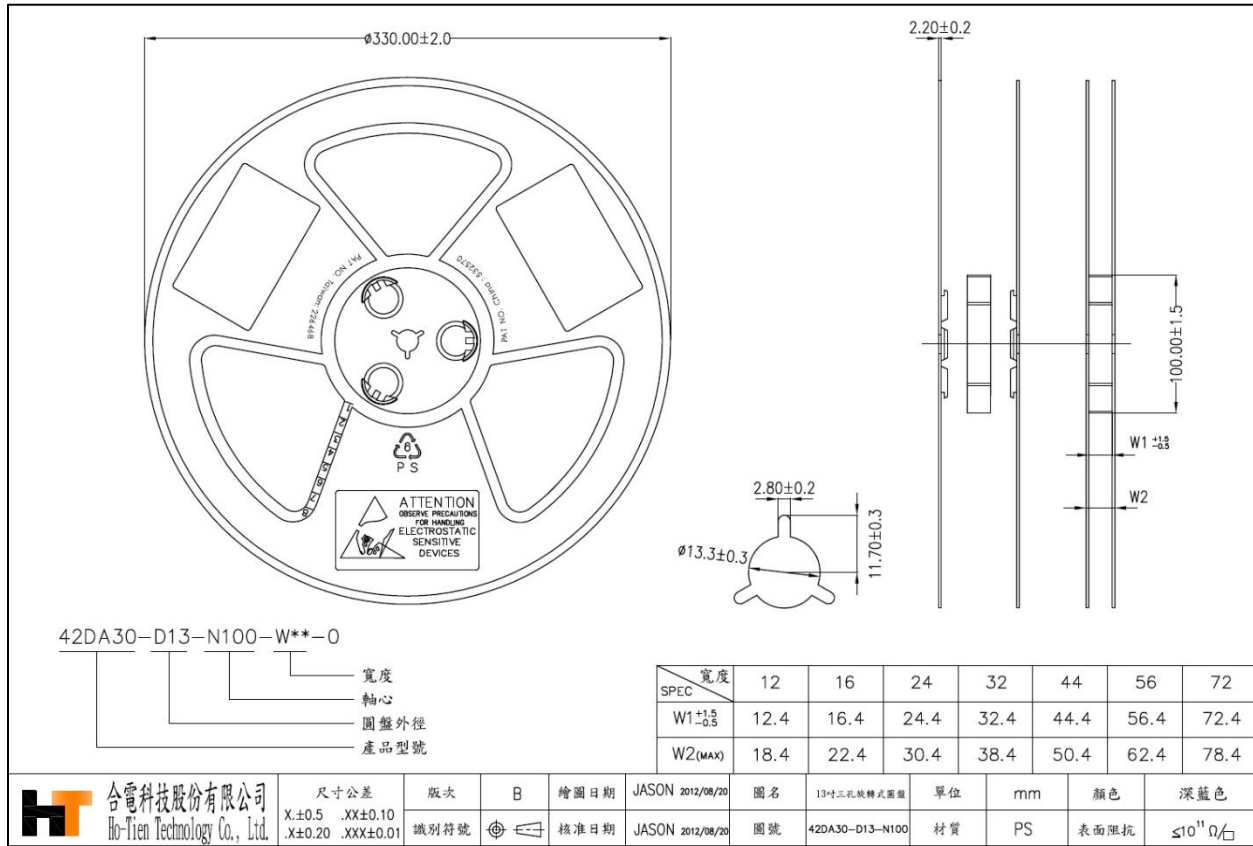

Figure 9: Reel specifications

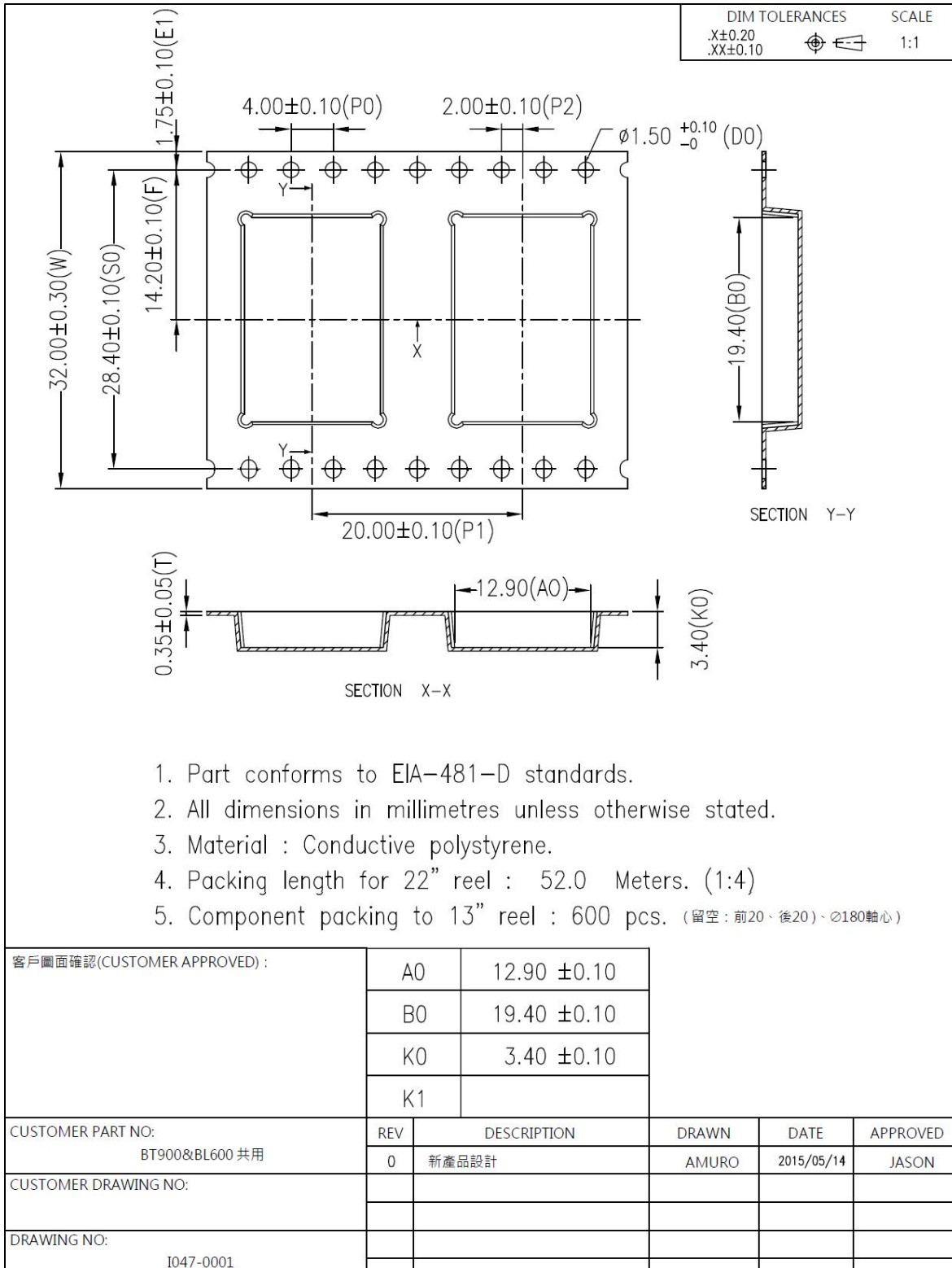

Figure 10: Tape specifications

There are 600 BT900 modules taped in a reel (and packaged in a pizza box) and four boxes per carton (2400 modules per carton). Reel, boxes, and carton are labeled with the appropriate labels. See following images (Figures 11-18).

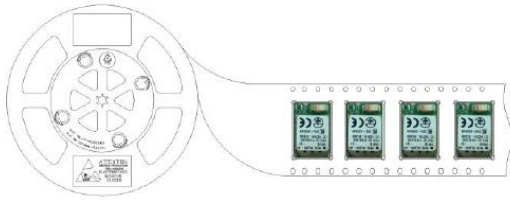

Figure 11: Reel with taped modules

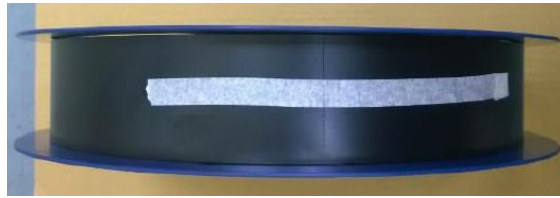

Figure 12: Filled reel



Figure 13: Labeled reel



Figure 14: Reel packaged in pizza box

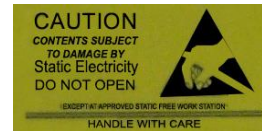

Figure 15: ESD label



Figure 16: Carton



Figure 17: Carton label

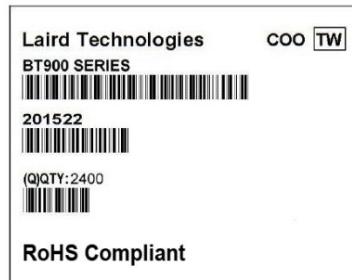

Figure 18: Reel label

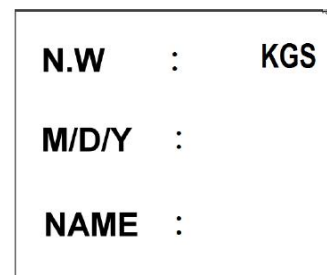

Figure 19: Check label

8.3. Reflow Parameters

Prior to any reflow, it is important to ensure the modules were packaged to prevent moisture absorption. New packages contain desiccant (to absorb moisture) and a humidity indicator card to display the level maintained during storage and shipment. If directed to *bake units* on the card, see [Table 18](#) and follow instructions specified by IPC/JEDEC J-STD-033. A copy of this standard is available from the JEDEC website: <http://www.jedec.org/sites/default/files/docs/jstd033b01.pdf>

Note: The shipping tray cannot be heated above 65°C. If baking is required at the higher temperatures displayed in in [Table 18](#), the modules must be removed from the shipping tray.

Any modules not manufactured before exceeding their floor life should be re-packaged with fresh desiccant and a new humidity indicator card. Floor life for MSL (Moisture Sensitivity Level) 3 devices is 168 hours in ambient environment ≤30°C/60%RH.

Table 18: Recommended baking times and temperatures

	125°C Baking Temp.		90°C/≤ 5%RH Baking Temp.		40°C/≤ 5%RH Baking Temp.	
	Saturated @ 30°C/85%	Floor Life Limit + 72 hours @ 30°C/60%	Saturated @ 30°C/85%	Floor Life Limit + 72 hours @ 30°C/60%	Saturated @ 30°C/85%	Floor Life Limit + 72 hours @ 30°C/60%
MSL						
3	9 hours	7 hours	33 hours	23 hours	13 days	9 days

Laird surface mount modules are designed to be easily manufactured, including reflow soldering to a PCB. Ultimately it is the responsibility of the customer to choose the appropriate solder paste and to ensure oven temperatures during reflow meet the requirements of the solder paste. Laird surface mount modules conform to J-STD-020D1 standards for reflow temperatures.

Important: During reflow, modules should not be above 260°C and not for more than 30 seconds.

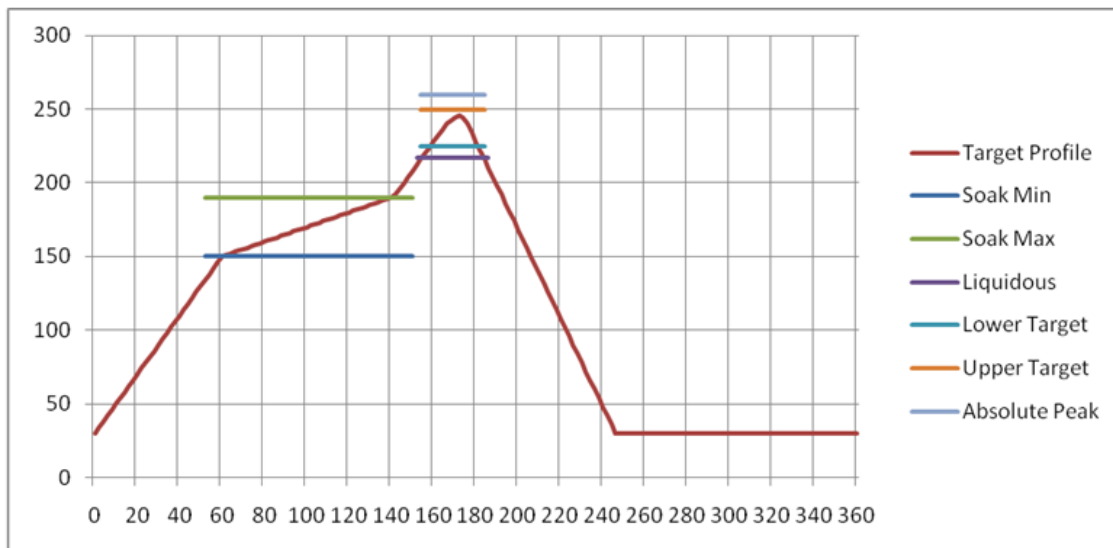

Figure 16: Recommended Reflow Temperature

Temperatures should not exceed the minimums or maximums presented in Table 19.

Table 19: Recommended Maximum and minimum temperatures

Specification	Value	Unit
Temperature Inc./Dec. Rate (max)	1~3	°C / Sec
Temperature Decrease rate (goal)	2-4	°C / Sec
Soak Temp Increase rate (goal)	.5 - 1	°C / Sec
Flux Soak Period (Min)	70	Sec
Flux Soak Period (Max)	120	Sec
Flux Soak Temp (Min)	150	°C
Flux Soak Temp (max)	190	°C
Time Above Liquidous (max)	70	Sec
Time Above Liquidous (min)	50	Sec
Time In Target Reflow Range (goal)	30	Sec
Time At Absolute Peak (max)	5	Sec
Liquidous Temperature (SAC305)	218	°C
Lower Target Reflow Temperature	240	°C
Upper Target Reflow Temperature	250	°C
Absolute Peak Temperature	260	°C

9 FCC AND IC REGULATORY STATEMENTS

Model	US/FCC	CANADA/IC
BT900-SA	SQGBT900	3147A-BT900
BT900-SC	SQGBT900	3147A-BT900

The BT900-SA and BT900-SC hold full modular approvals. The OEM must follow the regulatory guidelines and warnings listed below to inherit the modular approval.

Part #	Form Factor	TX Output	Antenna
BT900-SA-0X	Surface Mount	8 dBm	Ceramic
BT900-SC-0X	Surface Mount	8 dBm	u.FL

*Last two slots "0X" in Part # are used for production firmware release changes. Can be values 01-99, aa-zz

The BT900 family has been designed to operate with the antennas listed below with a maximum gain of 2.0 dBi. The required antenna impedance is 50 ohms.

Item	Part Number	Mfg.	Type	Gain (dBi)	Model
1	AT3216-B2R7HAA	ACX	Ceramic	0.5	BT900-SA
2	S181FL-L-RMM-2450S	Nearson	Dipole	2.0	BT900-SC
3	MAF94045	Laird	PCB Dipole	2.0	BT900-SC
4	MAF94017	Laird	Dipole	2.0	BT900-SC

Item	Part Number	Mfg.	Type	Gain (dBi)	Model
5	MAF94019	Laird	Dipole	1.5	BT900-SC

Note: The OEM is free to choose another vendor’s antenna of like type and equal or lesser gain as an antenna appearing in the table and still maintain compliance. Reference FCC Part 15.204(c)(4) for further information on this topic.

To reduce potential radio interference to other users, the antenna type and gain should be chosen so that the equivalent isotropic radiated power (EIRP) is not more than that permitted for successful communication.

9.1. Power Exposure Information

Federal Communication Commission (FCC) Radiation Exposure Statement:

This EUT is in compliance with SAR for general population/uncontrolled exposure limits in ANSI/IEEE C95.1-1999 and had been tested in accordance with the measurement methods and procedures specified in OET Bulletin 65 Supplement C.

This transceiver must not be co-located or operating in conjunction with any other antenna, transmitter, or external amplifiers. Further testing / evaluation of the end product will be required if the OEM’s device violates any of these requirements.

The BT900 is fully approved for mobile and portable applications.

9.2. OEM Responsibilities

WARNING: The OEM must ensure that FCC labelling requirements are met. This includes a clearly visible label on the outside of the OEM enclosure specifying the appropriate Laird Technology FCC identifier for this product.

Contains FCC ID: SQGBT900 IC: 3147A-BT900

If the size of the end product is larger than 8x10cm, then the following FCC part 15.19 statement has to also be available on visible on outside of device:

The enclosed device complies with Part 15 of the FCC Rules. Operation is subject to the following two conditions: (1) This device may not cause harmful interference, and (2) This device must accept any interference received, including interference that may cause undesired operation

Label and text information should be in a size of type large enough to be readily legible, consistent with the dimensions of the equipment and the label. However, the type size for the text is not required to be larger than eight point.

CAUTION: The OEM should have their device which incorporates the BT900 tested by a qualified test house to verify compliance with FCC Part 15 Subpart B limits for unintentional radiators.

CAUTION: Any changes or modifications not expressly approved by Laird could void the user’s authority to operate the equipment.

Note: This equipment has been tested and found to comply with the limits for a Class B digital device, pursuant to Part 15 of the FCC Rules. These limits are designed to provide reasonable protection against harmful interference in a residential installation. This equipment generates, uses, and can radiate radio frequency energy and, if not installed and used in accordance with the instructions, may cause harmful interference to radio communications. However, there is no guarantee that interference will not occur in a particular installation. If this equipment does not cause harmful interference to radio or television reception, which can be determined by turning the equipment off and on, the user is encouraged to correct the interference by one or more of the following measures:

- Re-orient or relocate the receiving antenna
- Increase the separation between the equipment and the receiver
- Connect the equipment to an outlet on a circuit that is different from that to which the receiver is connected.
- Consult the dealer or an experienced radio/TV technician for help.

FCC Warning:

"THIS DEVICE COMPLIES WITH PART 15 OF THE FCC RULES AND INDUSTRY CANADA LICENSE-EXEMPT RSS STANDARD(S). OPERATION IS SUBJECT TO THE FOLLOWING TWO CONDITIONS: (1) THIS DEVICE MAY NOT CAUSE HARMFUL INTERFERENCE, AND (2) THIS DEVICE MUST ACCEPT ANY INTERFERENCE RECEIVED, INCLUDING INTERFERENCE THAT MAY CAUSE UNDESIRE OPERATION.

Industry Canada (IC) Warning:

This device complies with Industry Canada license-exempt RSS standard(s). Operation is subject to the following two conditions: (1) this device may not cause interference, and (2) this device must accept any interference, including interference that may cause undesired operation of the device.

French equivalent is:

Le présent appareil est conforme aux CNR d'Industrie Canada applicable aux appareils radio exempts de licence. L'exploitation est autorisée aux deux conditions suivantes : (1) l'appareil ne doit pas produire de brouillage, et (2) l'utilisateur de l'appareil doit accepter tout brouillage radioélectrique subi, même si le brouillage est susceptible d'en compromettre le fonctionnement.

IC Radiation Exposure Statement

This EUT is compliance with SAR for general population/uncontrolled exposure limits in IC RSS-102 and had been tested in accordance with the measurement methods and procedures specified in IEEE 1528.

REMARQUE IMPORTANTE

Déclaration IC d'exposition aux radiations

Ce EUT est conforme avec SAR pour la population générale / limites d'exposition non contrôlée à IC RSS-102 et a été testé en conformité avec les méthodes de mesure et procédures spécifiées dans la norme IEEE 1528.

Modular Approval

OEM integrator is still responsible for testing their end product for any additional compliance requirements required with this module installed (for example, digital device emissions, PC peripheral requirements, etc.).

Approbation modulaire

OEM intégrateur est toujours responsable de tester leur produit final pour les exigences de conformité supplémentaires nécessaires à ce module installé (par exemple, les émissions de périphériques numériques, les exigences de périphériques PC, etc.)

IMPORTANT NOTE:

In the event that these conditions cannot be met (for example certain laptop configurations or co-location with another transmitter), then the Canada authorization is no longer considered valid and the IC ID cannot be used on the final product. In these circumstances, the OEM integrator will be responsible for re-evaluating the end product (including the transmitter) and obtaining a separate Canada authorization.

NOTE IMPORTANTE:

Dans le cas où ces conditions ne peuvent être satisfaites (par exemple pour certaines configurations d'ordinateur portable ou de certaines co-localisation avec un autre émetteur), l'autorisation du Canada n'est plus considéré comme valide et l'ID IC ne peut pas être utilisé sur le produit final. Dans ces circonstances, l'intégrateur OEM sera chargé de réévaluer le produit final (y compris l'émetteur) et l'obtention d'une autorisation distincte au Canada.

Le produit final doit être étiqueté dans un endroit visible avec l'inscription suivante: " BT900-SA and BT900-SC Contient des IC: TBC".

10 JAPAN (MIC) REGULATORY

The BT900 is approved for use in the Japanese market. The part numbers listed below hold WW type certification. Refer to **ARIB-STD-T66** for further guidance on OEM's responsibilities.

Model	Certificate Number	Antenna
BT900-SA	142150156/AA/00	Ceramic
BT900-SC	142150157/AA/00	uFL

10.1. Antenna Information

The BT900 was tested with antennas listed below. The OEM can choose a different manufacturers antenna but must make sure it is of same type and that the gain is lesser than or equal to the antenna that is approved for use.

Item	Part Number	Mfg.	Type	Gain (dBi)	Model
1	AT3216-B2R7HAA	ACX	Ceramic	0.5	BT900-SA
2	S181FL-L-RMM-2450S	Nearson	Dipole	2.0	BT900-SC
3	MAF94045	Laird	PCB Dipole	2.0	BT900-SC
4	MAF94017	Laird	Dipole	2.0	BT900-SC
5	MAF94019	Laird	Dipole	1.5	BT900-SC

11 CE REGULATORY

The BT900-SA / BT900-SC have been tested for compliance with relevant standards for the EU market. The BT900-SC module was tested with a 2.21 dBi antenna. The OEM can operate the BT900-SC module with any other type of antenna but must ensure that the gain does not exceed 2.21 dBi to maintain the Laird approval.

The OEM should consult with a qualified test house before entering their device into an EU member country to make sure all regulatory requirements have been met for their complete device.

Table 20: Reference standards used for presumption of conformity

provides a full list of the standards to which the modules were tested. Test reports are available from the website's product page.

11.1. Antenna Information

The antennas listed below were tested for use with the BT900. For CE mark countries, the OEM is free to use any manufacturer's antenna and type of antenna as long as the gain is less than or equal to the highest gain approved for use (2.21dBi) Contact a Laird representative for more information regarding adding antennas.

Item	Part Number	Mfg.	Type	Gain (dBi)	Model
1	AT3216-B2R7HAA	ACX	Ceramic	0.5	BT900-SA
2	S181FL-L-RMM-2450S	Nearson	Dipole	2.0	BT900-SC
3	MAF94045	Laird	PCB Dipole	2.0	BT900-SC
4	MAF94017	Laird	Dipole	2.0	BT900-SC
5	MAF94019	Laird	Dipole	1.5	BT900-SC

12 EU DECLARATIONS OF CONFORMITY

12.1. BT900-SA/BT900-SC

Manufacturer	Laird
Products	BT900-SA, BT900-SC
Product Description	2.4 GHz Bluetooth/Bluetooth Low Energy (BLE) module
EU Directives	2014/53/EU – Radio Equipment Directive (RED)

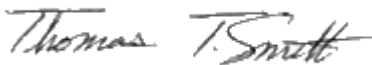

Table 20: Reference standards used for presumption of conformity

Article Number	Requirement	Reference standard(s)
3.1a	Low voltage equipment safety	EN 60950-1:2006+A11:2009+A1:2010+A12:2011+A2:2013
	RF Exposure	EN 62311:2008
3.1b	Protection requirements with respect to electromagnetic compatibility	EN 301 489-1 v2.2.0 (2017-03) EN 301 489-17 v3.2.0 (2017-03)
3.2	Means of the efficient use of the radio frequency spectrum (ERM)	EN 300 328 v2.1.1 (2016-11)

Declaration:

We, Laird, declare under our sole responsibility that the essential radio test suites have been carried out and that the above product to which this declaration relates is in conformity with all the applicable essential requirements of Article 3 of the EU Directive 2014/53/EU, when used for its intended purpose.

Place of Issue:	Laird W66N220 Commerce Court, Cedarburg, WI 53012 USA tel: +1-262-375-4400 fax: +1-262-364-2649
Date of Issue:	02 May 2017
Name of Authorized Person:	Thomas T Smith, Director of EMC Compliance
Signature of Authorized Person:	

13 ORDERING INFORMATION

Part Number	Description
BT900-SA-0x	Intelligent BTv4.0 Dual Mode Module featuring <i>smart</i> BASIC – integrated antenna
BT900-SC-0x	Intelligent BTv4.0 Dual Mode Module featuring <i>smart</i> BASIC – uFL connector
DVK – BT900-SA-0x	Development board with BT900-SA module soldered in place
DVK – BT900-SC-0x	Development board with BT900-SC module soldered in place

Note: Ordering information for Tape and Reel packaging is an addition of T/R to the end of the full module part number. For example, BT900-SC-0x becomes BT900-SC-0x-T/R.

14 BLUETOOTH SIG QUALIFICATION

The BT900 module is listed on the Bluetooth SIG website as a qualified Controller Subsystem.

Laird’s Controller Subsystem is then combined with the StoneStreet One Bluetooth ost and Profile subsystems to create the complete Bluetooth SIG qualification, in the steps listed in this application note.

Design Name	Owner	Declaration ID	QD ID	Link to listing on the SIG website
BT900	Laird	D023116	58778	https://www.bluetooth.org/tpg/QLI_viewQDL.cfm?qid=23116
Bluetooth Host	StoneStreet One	B019355	37180	https://www.bluetooth.org/tpg/QLI_viewQDL.cfm?qid=19355
BlueTopia Profile	StoneStreet One	B020402	42849	https://www.bluetooth.org/tpg/QLI_viewQDL.cfm?qid=20402

It is a mandatory requirement of the Bluetooth Special Interest Group (SIG) that every product implementing Bluetooth technology has a Declaration ID. Every Bluetooth design is required to go through the qualification process, even when referencing a Bluetooth Design that already has its own Declaration ID. The Qualification Process requires each company to register as a member of the Bluetooth SIG – www.bluetooth.org

The following is a link to the Bluetooth Registration page: <https://www.bluetooth.org/login/register/>

For each Bluetooth Design it is necessary to purchase a Declaration ID. This can be done before starting the new qualification, either through invoicing or credit card payment. The fees for the Declaration ID will depend on your membership status, please refer to the following webpage:

<https://www.bluetooth.org/en-us/test-qualification/qualification-overview/fees>

For a detailed procedure of how to obtain a new Declaration ID for your design, please refer to the following SIG document:

https://www.bluetooth.org/DocMan/handlers/DownloadDoc.ashx?doc_id=283698&vId=317486

14.1. Qualification Steps When Using a Laird Controller Subsystem Design

To qualify your product when referencing a Laird Controller Subsystem design, follow these steps:

1. To start a listing, go to: https://www.bluetooth.org/tpg/QLI_SDoc.cfm

Note: A user name and password are required to access this site.

2. In step 1, select the option, New Listing and Reference a Qualified Design.
3. Enter 58778 in the Controller Subsystem table entry.
4. Add you complimentary Host Subsystem and optional Profile Subsystem to complete the design
37180 for Stonestreet One Bluetopia Host Subsystem 4.0 and,
42849 for Stonestreet One Bluetopia Profile Subsystem
5. Select your pre-paid Declaration ID from the drop down menu or go to the Purchase Declaration ID page.

Note: Unless the Declaration ID is pre-paid or purchased with a credit card, you cannot proceed until the SIG invoice is paid.

6. Once all the relevant sections of step 1 are finished, complete steps 2, 3, and 4 as described in the help document accessible from the site.

Your new design will be listed on the SIG website and you can print your Certificate and SDoC.

For further information please refer to the following training material:

<https://www.bluetooth.org/en-us/test-qualification/qualification-overview/listing-process-updates>

15 ADDITIONAL ASSISTANCE

Please contact your local sales representative or our support team for further assistance:

Laird Technologies Connectivity Products Business Unit

Support Center: <https://connectivity.lairdtech.com/resources/support>

Email: wireless.support@lairdtech.com

Phone: Americas: +1-800-492-2320

Europe: +44-1628-858-940

Hong Kong: +852 2923 0610

Web: <https://connectivity.lairdtech.com/wireless-modules/bluetooth-modules>

© Copyright 2019 Laird. All Rights Reserved. Patent pending. Any information furnished by Laird and its agents is believed to be accurate and reliable. All specifications are subject to change without notice. Responsibility for the use and application of Laird materials or products rests with the end user since Laird and its agents cannot be aware of all potential uses. Laird makes no warranties as to non-infringement nor as to the fitness, merchantability, or sustainability of any Laird materials or products for any specific or general uses. Laird, Laird Technologies, Inc., or any of its affiliates or agents shall not be liable for incidental or consequential damages of any kind. All Laird products are sold pursuant to the Laird Terms and Conditions of Sale in effect from time to time, a copy of which will be furnished upon request. When used as a tradename herein, *Laird* means Laird PLC or one or more subsidiaries of Laird PLC. Laird™, Laird Technologies™, corresponding logos, and other marks are trademarks or registered trademarks of Laird. Other marks may be the property of third parties. Nothing herein provides a license under any Laird or any third party intellectual property right.