



TAOGLAS®



Datasheet

Part No:
GW.05.0ZZ23

Description:

Dual-Band Wi-Fi 2.4~2.5GHz/5.15~7.2GHz Terminal Mount Monopole Antenna

Features:

- High Efficiency – with and without ground plane
- Wi-Fi/Bluetooth 2.4/5.8/7.1GHz
- Covers Wi-Fi 6 Frequencies: 5.9-7.2GHz
- Extremely Compact – 69.6mm
- Aesthetic look and feel
- Unique can rotate 360 degrees and articulate through 180 degrees
- Max Peak Gain compliant with most Wi-Fi modules
- Connector: Fakra Code Z Water Blue SMB(F)
- Dimensions: 69.6*Ø10mm
- CE Certified
- RoHS & Reach Compliant



www.taoglas.com

1. Introduction	3
2. Specifications	5
3. Antenna Characteristics	6
4. Radiation Patterns	9
5. Mechanical Drawing	16
6. Packaging	17
<hr/>	
Changelog	18

Taoglas makes no warranties based on the accuracy or completeness of the contents of this document and reserves the right to make changes to specifications and product descriptions at any time without notice. Taoglas reserves all rights to this document and the information contained herein. Reproduction, use or disclosure to third parties without express permission is strictly prohibited.



1. Introduction



The GW.05 dual band Wi-Fi Hinged Rotatable Antenna is a high efficiency monopole antenna with the capacity to cover Wi-Fi 6 frequencies up to 7.125GHz. Compared to other much larger antennas on the market, it has superior wide-band high efficiency characteristics. The direct mount Fakra connector enables a more robust mating to the device compared to a SMA, the locking feature prevents the antenna coming loose due to vibration or shock. The FAKRA Connector means it is also suitable for use in conjunction with the next generation of Routers and Gateways.

The GW.05, as all monopole antennas, works best connected directly to the ground-plane of the device main PCB or to the outside of a metal housing. However, it still has very good performance (>50%) even without connecting to a ground-plane, making it the best all round small Wi-Fi terminal antenna on the market.

In the un-grounded installation condition, it also comes below the max peak gain requirements for most Wi-Fi modules which are usually 2dBi, so it can comply with FCC regulations. The GW.05 is for Wi-Fi, WLAN, Zigbee, Bluetooth, and 802.11a/b/g/n/ac applications.

Many module manufacturers specify peak gain limits for any antennas that are to be connected to that module. Those peak gain limits are based on free-space conditions. In practice, the peak gain of an antenna tested in free-space can degrade by at least 1 or 2dBi when put inside a device. So ideally you should go for a slightly higher peak gain antenna than mentioned on the module specification to compensate for this effect, giving you better performance.

Upon testing of any of our antennas with your device and a selection of appropriate layout, integration technique, or cable, Taoglas can make sure any of our antennas' peak gain will be below the peak gain limits. Taoglas can then issue a specification and/or report for the selected antenna in your device that will clearly show it complying with the peak gain limits, so you can be assured you are meeting regulatory requirements for that module.

For example, a module manufacturer may state that the antenna must have less than 2dBi peak gain, but you don't need to select an embedded antenna that has a peak gain of less than 2dBi in free-space. This will give you a less optimized solution. It is better to go for a slightly higher free-space peak gain of 3dBi or more if available. Once that antenna gets integrated into your device, performance will degrade below this 2dBi peak gain due to the effects of GND plane, surrounding components, and device housing. If you want to be absolutely sure, contact Taoglas and we will test. Choosing a Taoglas antenna with a higher peak gain than what is specified by the module manufacturer and enlisting our help will ensure you are getting the best performance possible without exceeding the peak gain limits.

It is better not to select an embedded antenna with very low free-space peak gain (<2dBi) directly, as this antenna would have worse performance in your device, and lead to compromised performance compared to using a Taoglas antenna.

This antenna's colour and connector and be customized subject to NRE, for further information please contact your regional Taoglas customer support team.



2. Specifications

Free Space Electrical									
Band	Frequency (MHz)	Setup	Efficiency (%)	Average Gain (dB)	Peak Gain (dBi)	Impedance	Max Power Input	Polarization	Radiation Pattern
2.4GHz Wi-Fi	2400~2500	Straight	60.3	-2.19	-0.83	50Ω	10W	Linear	Omnidirectional
		90° Bent	46.3	-3.35	2.92				
5.8GHz Wi-Fi	5150~5850	Straight	64.2	-1.93	2.64				
		90° Bent	65.8	-1.82	2.91				
7.1GHz Wi-Fi 6	5925~7125	Straight	33.6	-4.74	1.41				
		90° Bent	53.3	-2.73	2.61				

Mechanical	
Antenna length	69.6mm
Antenna Diameter	10mm
Casing	POM
Connector	FAKRA Code Z Water Blue Jack
Weight	8g
Environmental	
Operation Temperature	-40°C ~ + 85°C
Storage Temperature	-40°C ~ + 85°C
Humidity	Non-condensing 65°C 95% RH

3. Antenna Characteristics

3.1 Return Loss – Free Space

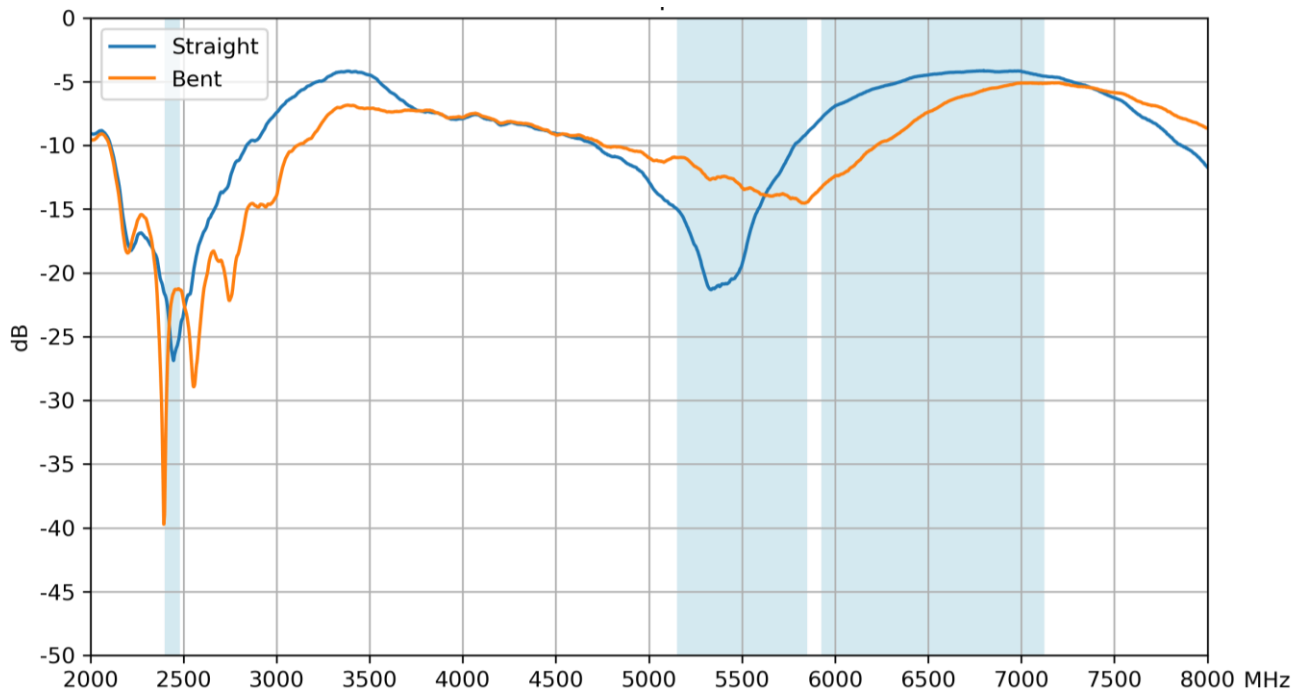

3.2 VSWR – Free Space

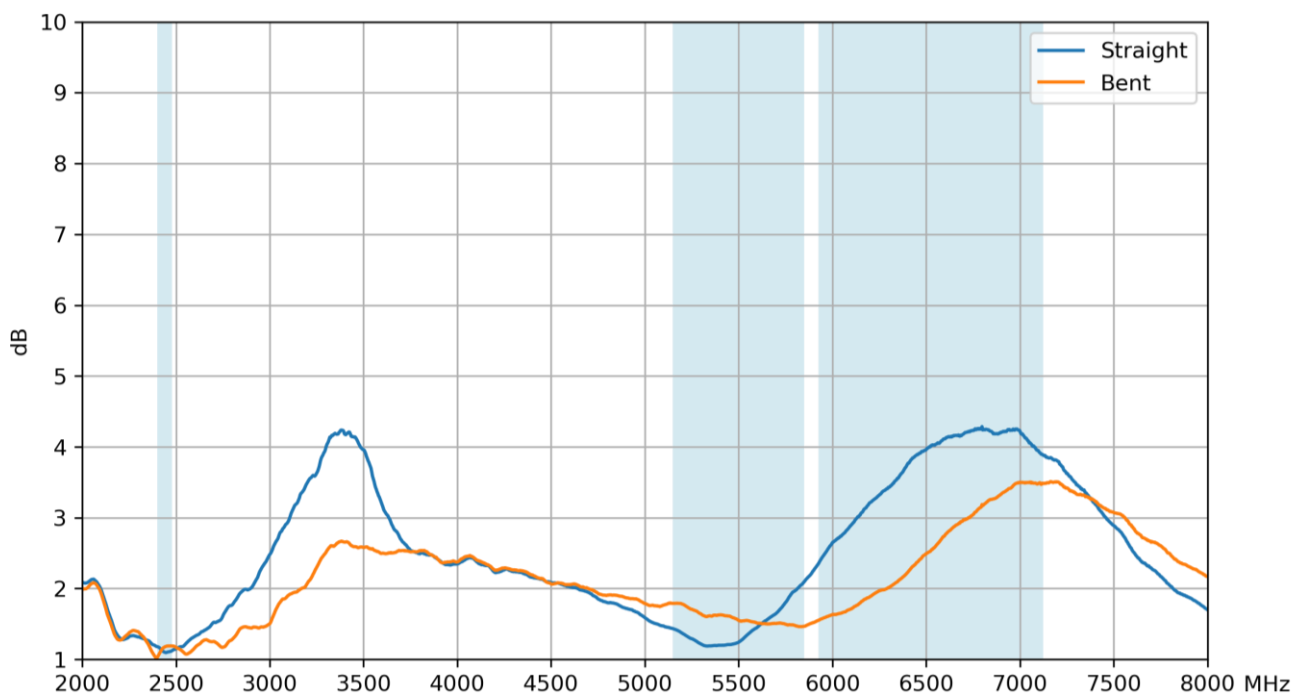

3.3 Efficiency – Free Space

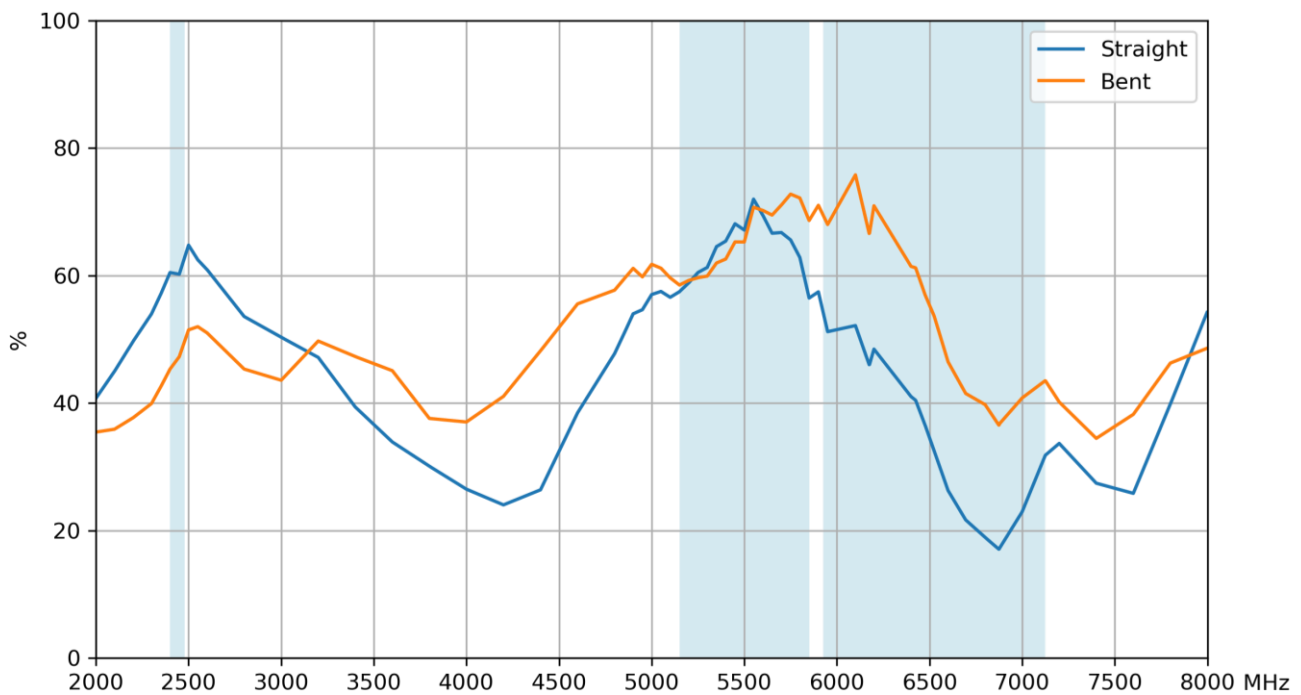

3.4 Average Gain – Free Space

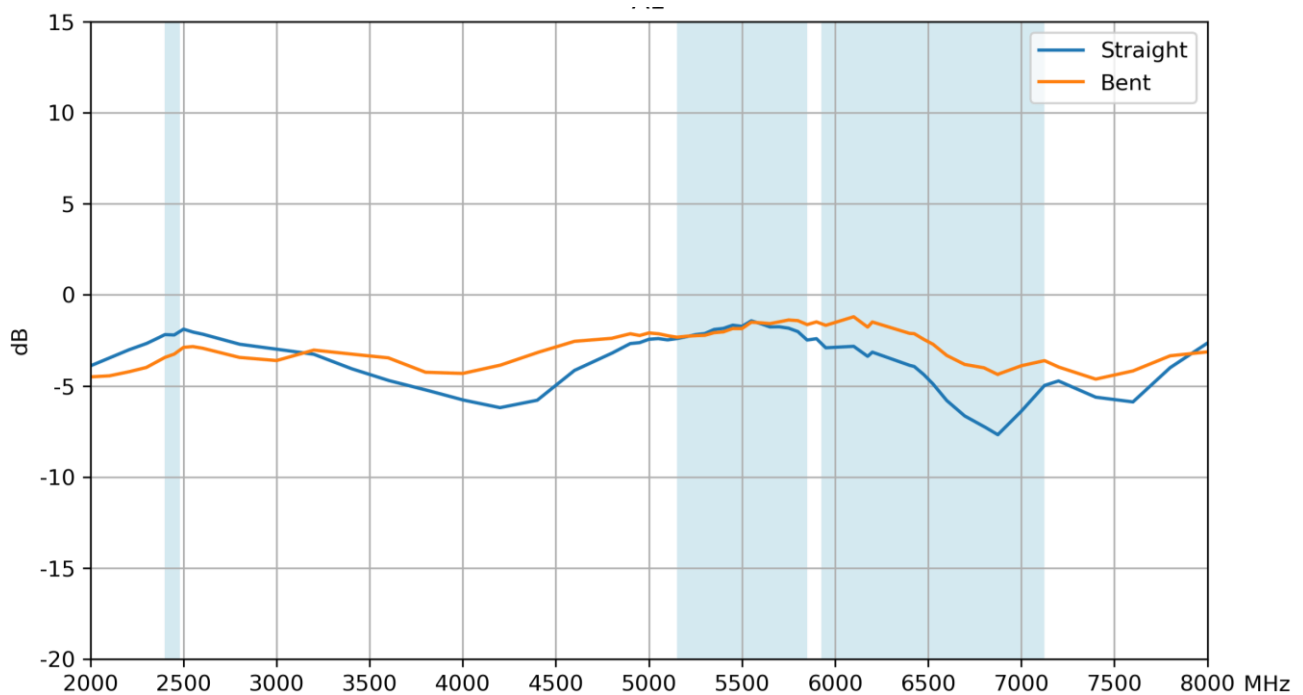

3.5 Peak Gain – Free Space

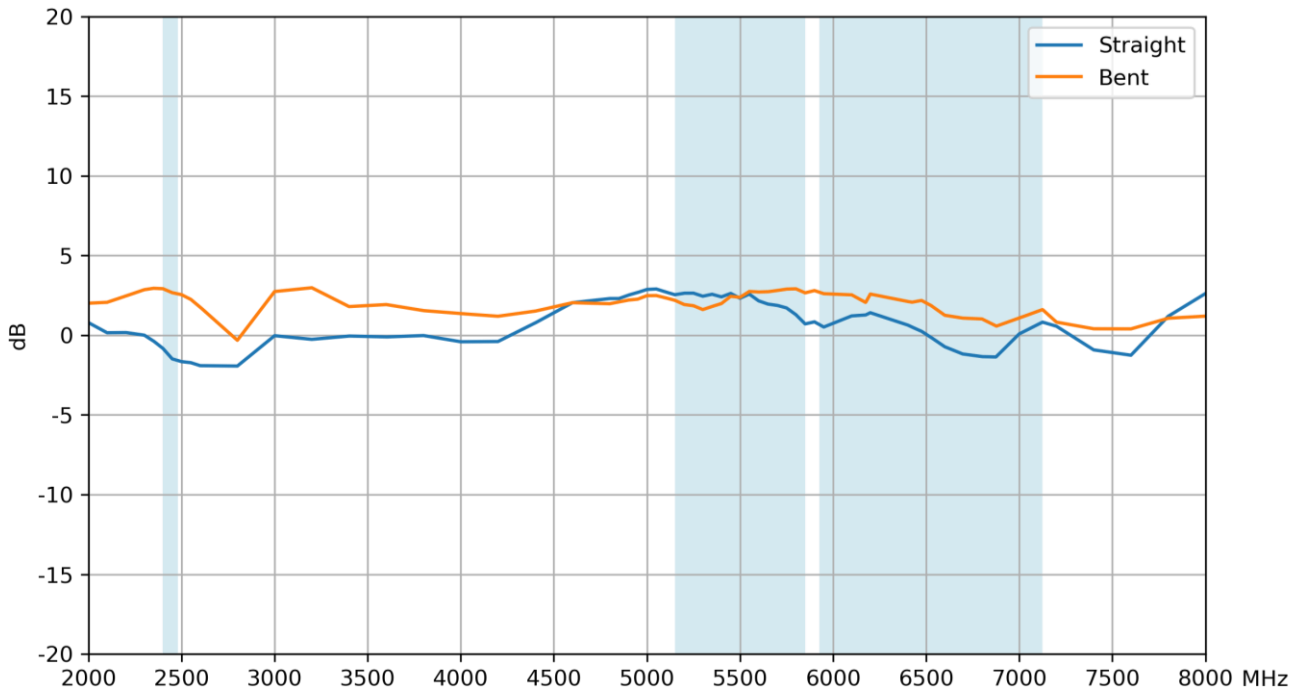

4. Radiation Patterns

4.1 Test Setup – Straight

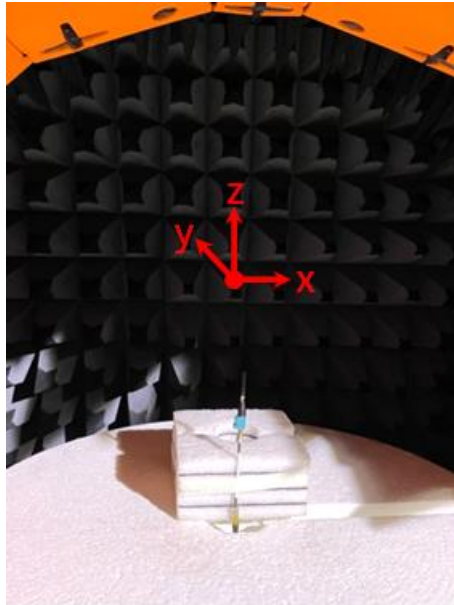

4.2 Test Setup – Bent (90°)

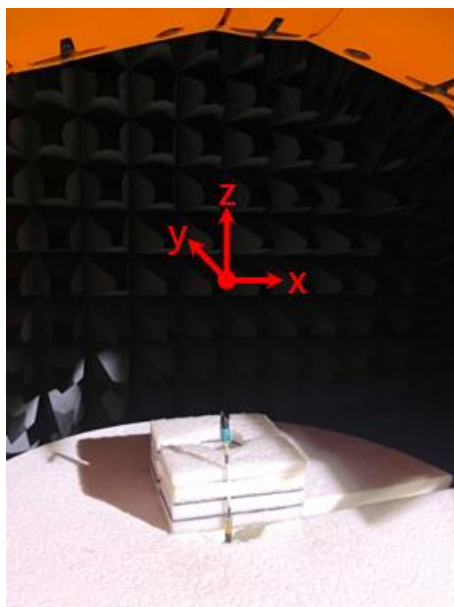

4.2 Straight 3D and 2D Radiation Patterns

2450MHz

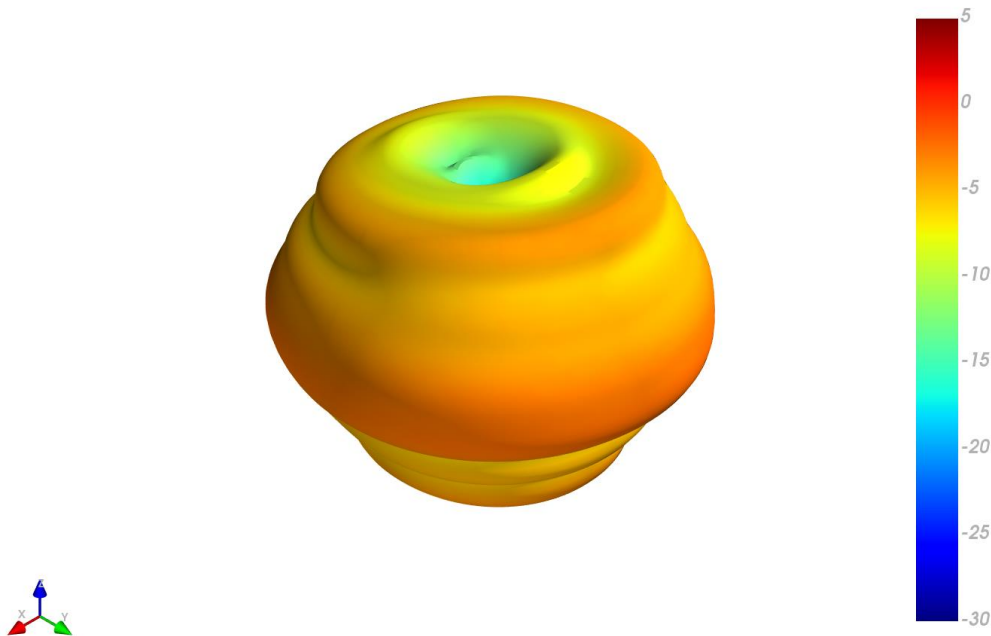

XY Plane

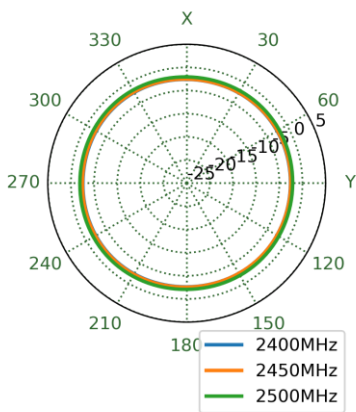

XZ Plane

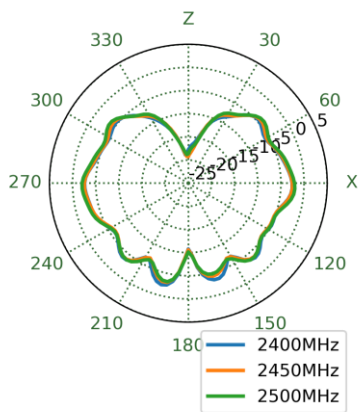

YZ Plane

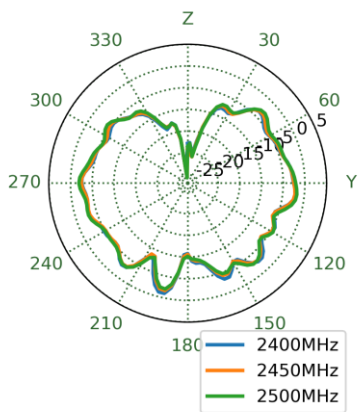

5550MHz

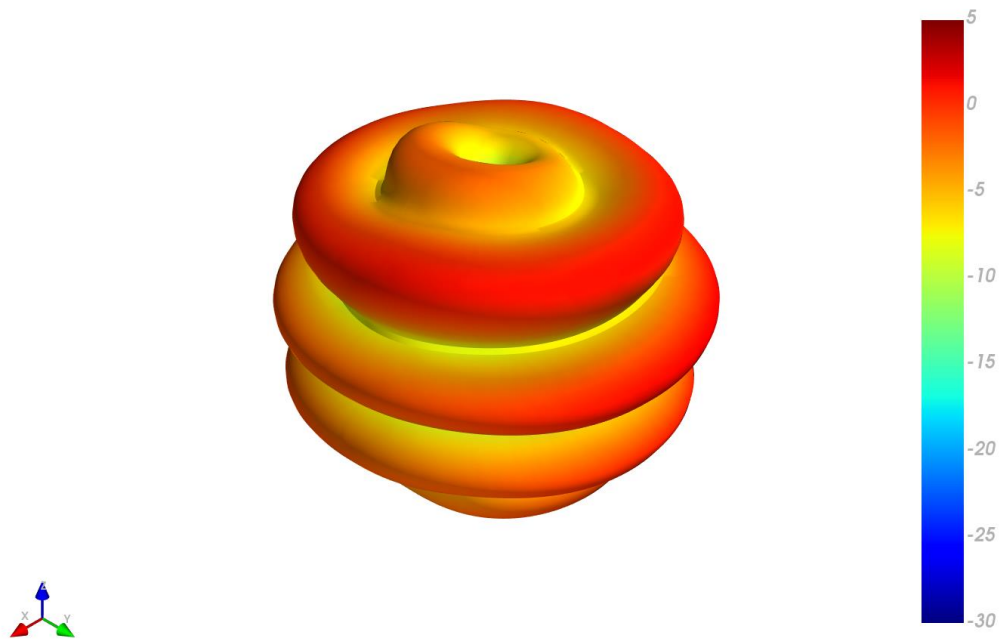

XY Plane

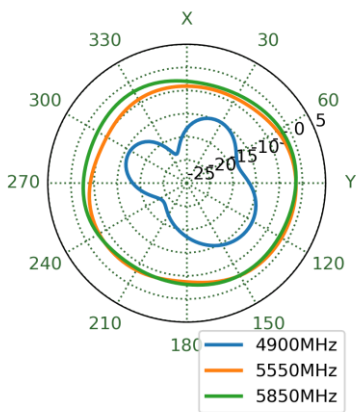

XZ Plane

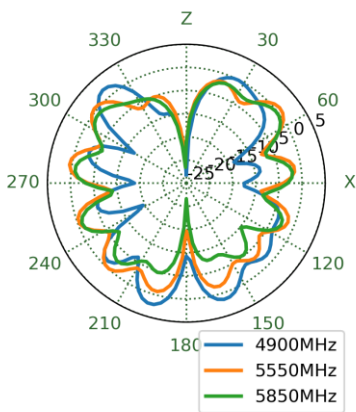

YZ Plane

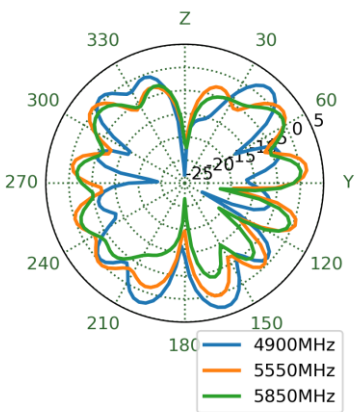

6525MHz

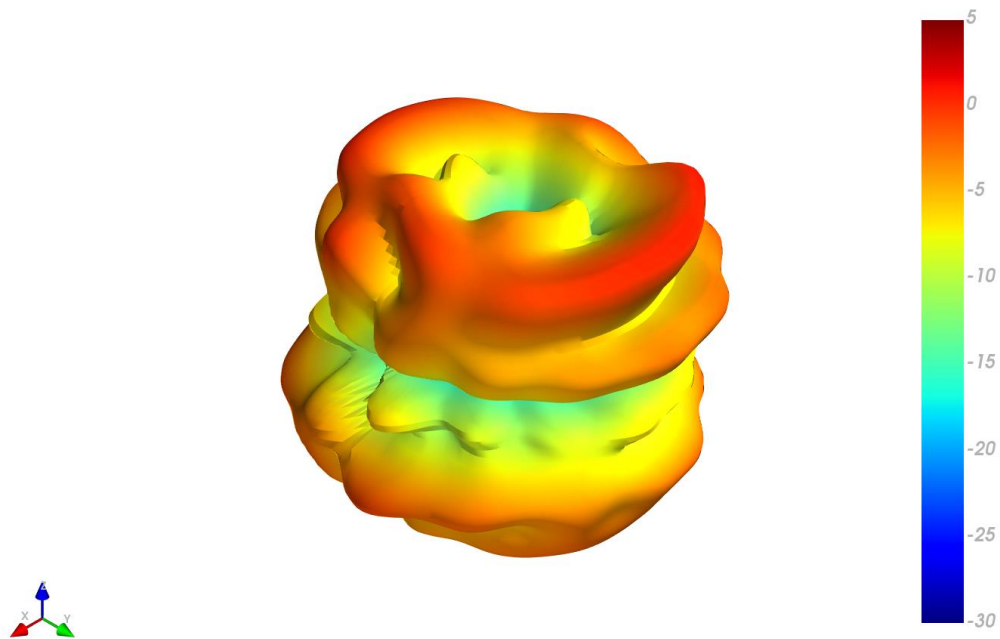

XY Plane

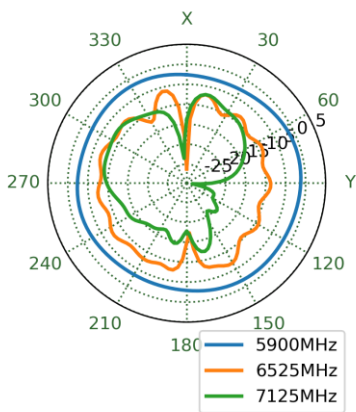

XZ Plane

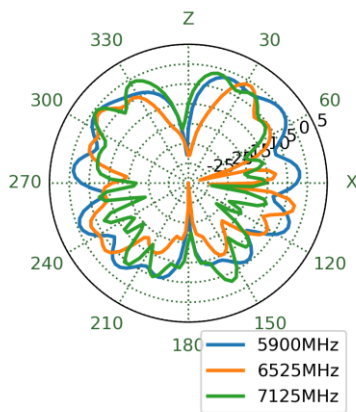

YZ Plane

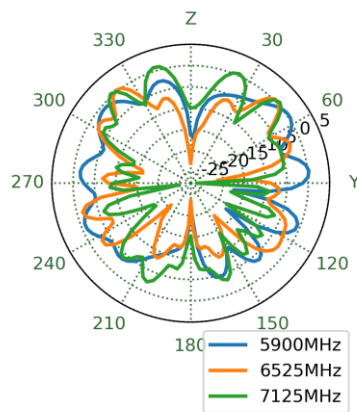

4.3 Bent 3D and 2D Radiation Patterns

2450MHz

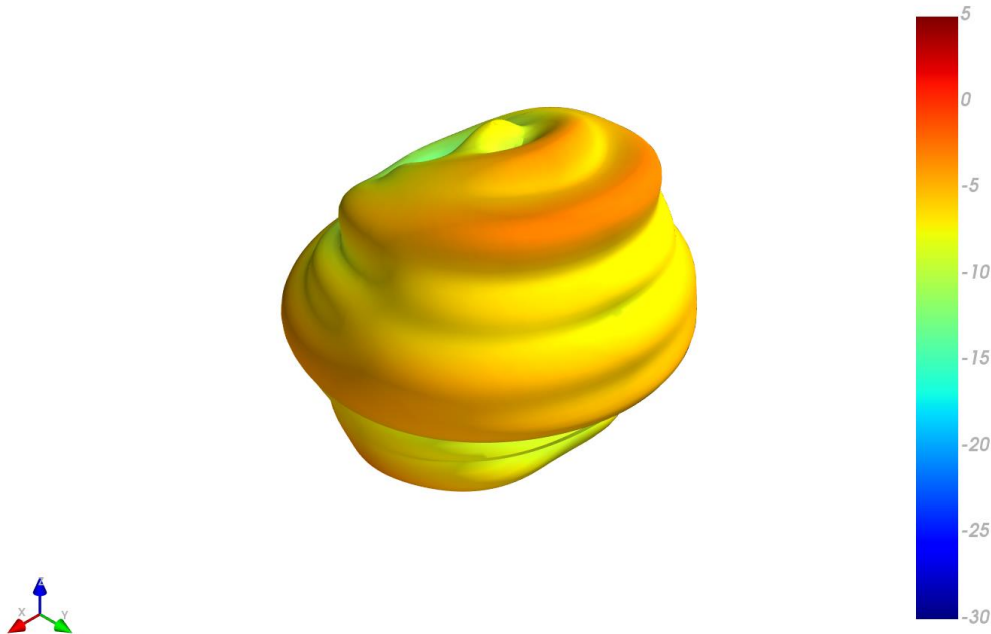

XY Plane

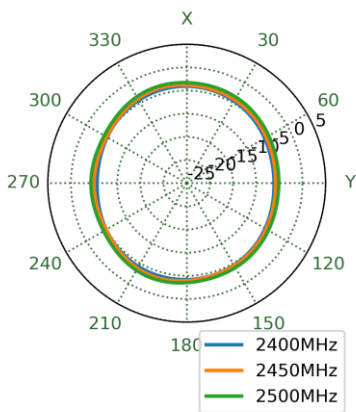

XZ Plane

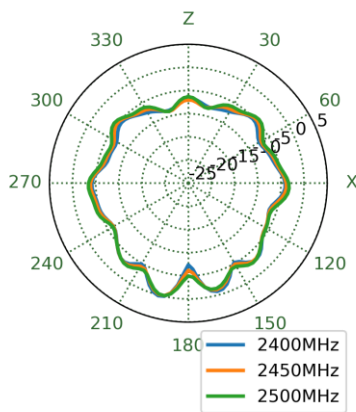

YZ Plane

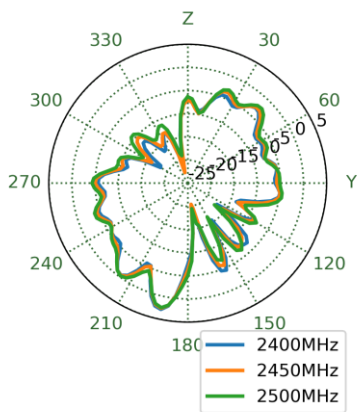

5550MHz

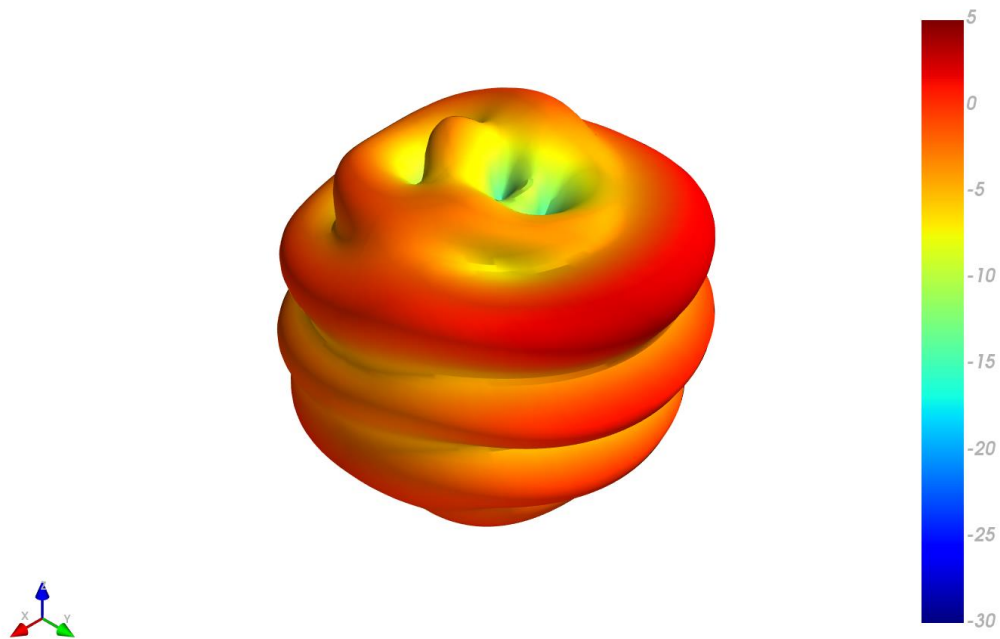

XY Plane

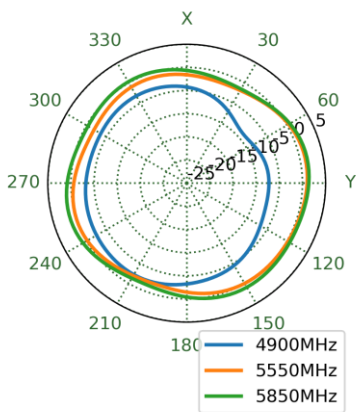

XZ Plane

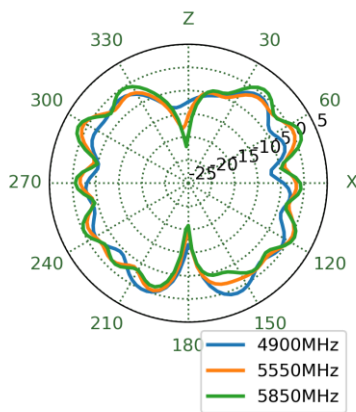

YZ Plane

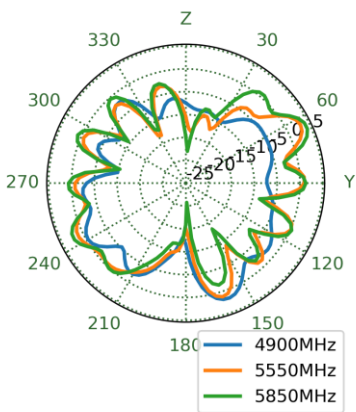

6525MHz

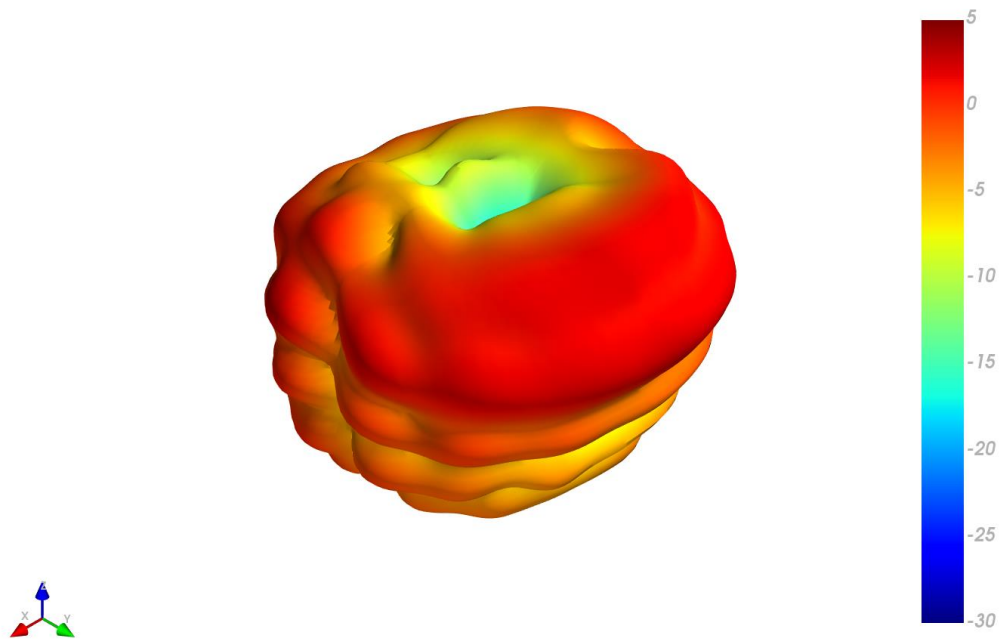

XY Plane

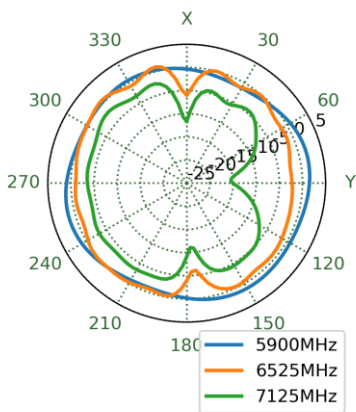

XZ Plane

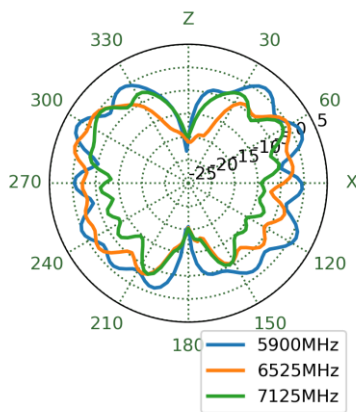

YZ Plane

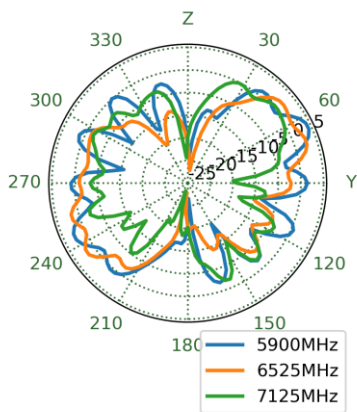

5. Mechanical Drawing (Units: mm)

ISO NO.: EDW-21-8-1184

STATE: Release

NOTES: 1. All material must be RoHS compliant.

REV.	DESCRIPTION	ENG.	APPROVED	DATE
D01	Initial Design	Ruby	Aaron	2021/10/08

Fakra Code Z

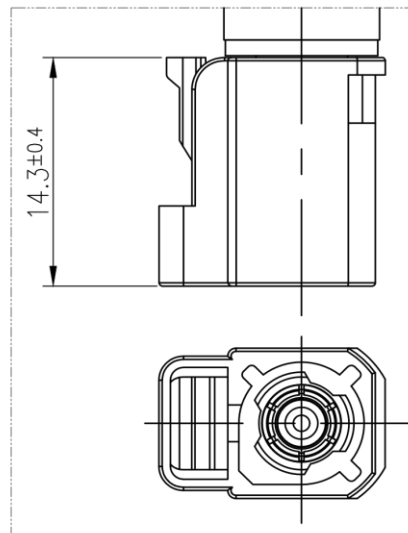

Detail A
Scale: 2:1

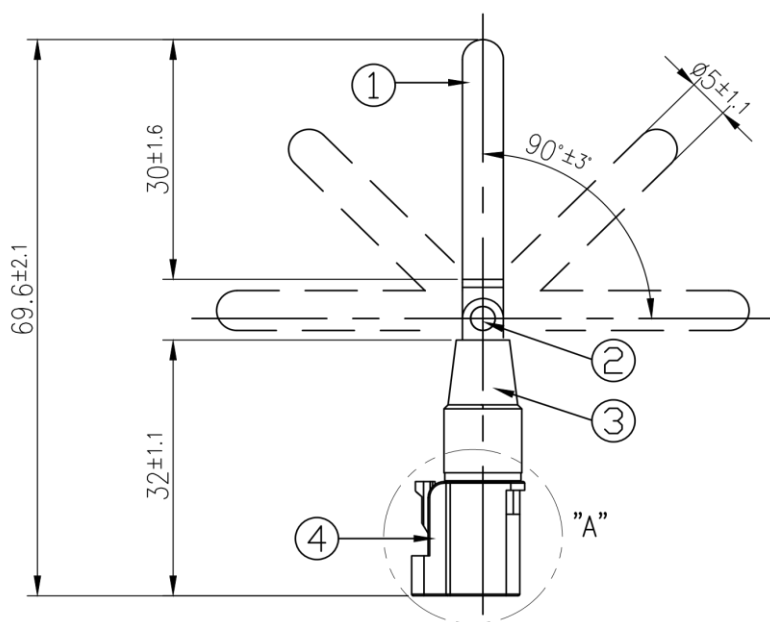

	Name	Material	Finish	QTY
1	Housing	POM	Black	1
2	Hinge	Brass	Ni Plated	1
3	Cap	POM	Black	1
4	Fakra Code Z	PA66	Water Blue	1

APPROVED BY: Aaron	TW Design Centre This drawing and its inherent design concepts are property of Taoglas. Not to be copied or given to third parties without the written consent of Taoglas.
CHECK BY: Aaron	
DRAWN BY: Ruby	
DATE: 2021/10/08	
UNLESS OTHERWISE SPECIFIED TOLERANCES ON: XX ± 0.5 X ± 0.3 3 ± 0.2 .XX ± 0.1 .XXX ± 0.05	TITLE : 2.4/5.8GHz Terminal mount Monopole Antenna Hinged FAKRA Code Z Water Blue SMB(F) PART NO. : GW.05.0ZZ23
THIRD ANGLE PROJECTION	UNIT: mm SCALE: 1.25:1 PAGES: 1/1 REV: D01

6. Packaging

1pc GW.05.0ZZ23 per small PE bag
 Bag Dimensions - 86*52 mm
 Weight - 8.5g

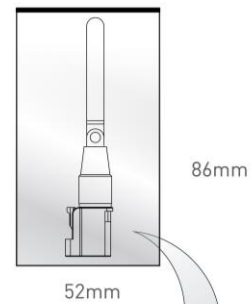

100pcs GW.05.0ZZ23 per large PE bag
 Bag Dimensions - 280*180 mm
 Weight - 0.85Kg

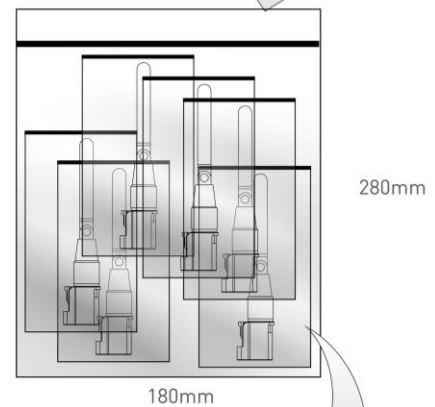

1000pcs GW.05.0ZZ23 per carton
 Carton Dimensions - 360*310*160mm
 Weight - 9Kg

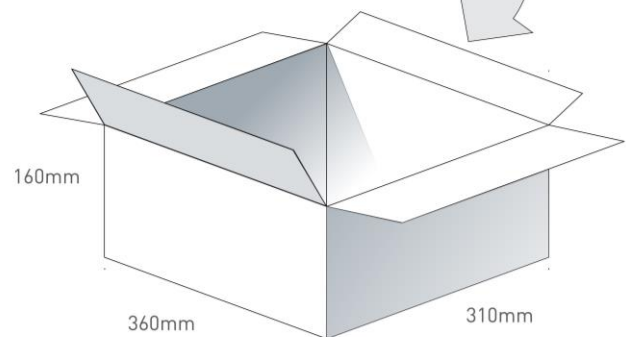

Pallet Dimensions 1200mm*1000mm*1480mm
 72 Cartons per Pallet
 9 Cartons per layer
 8 Layers

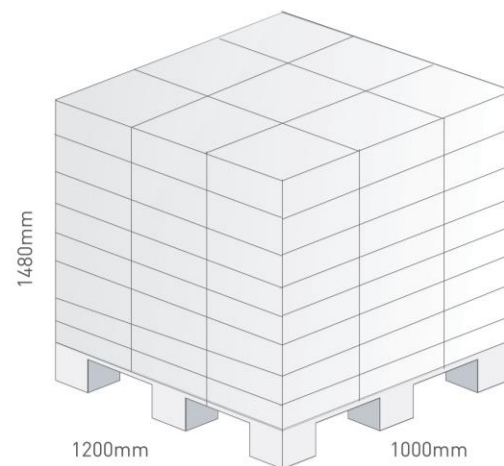

Changelog for the datasheet

SPE-21-8-122 – GW.05.0ZZ23

Revision: A (Original First Release)

Date:	2021-12-13
Notes:	
Author:	Jack Conroy

Previous Revisions



TAOGLAS®

www.taoglas.com

