

1200V SiC MOSFET

V_{DS}	1200 V
$R_{DS,on}$	37 m Ω
I_D (TC=25°C)	63 A
$T_{j,max}$	175°C

Features

- High speed switching
- Reliable body diode
- All parts tested to greater than 1,400V
- Avalanche tested to 400mJ*

Benefits

- Lower capacitance
- Higher system efficiency
- Easy to parallel

Applications

- Solar Inverters
- Switch mode power supplies, UPS
- Induction heating and welding
- EV charging stations
- High voltage DC/DC converters
- Motor drives

Package

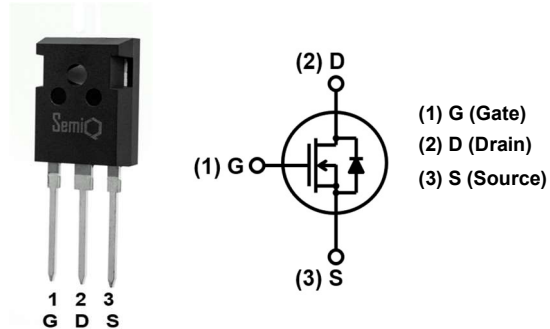

Part #	Package	Marking
GP2T040A120U	TO-247-3L	2T040A120



Maximum Ratings, at $T_j=25^\circ\text{C}$, unless otherwise specified

Characteristics	Symbol	Conditions	Values	Unit
Drain-Source Voltage	V_{rated}	$V_{GS}=0V, I_{DS}=1\mu A$	1200	V
Continuous Drain Current	I_D	$T_C=25^\circ\text{C}, T_j=175^\circ\text{C}$	63	A
		$T_C=100^\circ\text{C}, T_j=175^\circ\text{C}$	47	
Pulsed Drain Current	$I_{D,pulse}^*$	$T_C=25^\circ\text{C}$	160	
Gate Source Voltage	V_{GSmax}		-10/25	V
	V_{GSop}	Recommended operational	-5/20	
Power Dissipation	P_{tot}	$T_C=25^\circ\text{C}$	322	W
Operating & Storage Temperature	$T_j, T_{storage}$	Continuous	-55...175	$^\circ\text{C}$
Single Pulse Avalanche Energy	E_{AS}	$L=1.0mH, I_{AS}=28.3A, V=50V$	400	mJ

Thermal Characteristics

Characteristics	Symbol	Conditions	Values			Unit
			min.	typ.	max.	
Thermal Resistance, Junction to Case	R_{thJC}		-	0.38	0.47	$^\circ\text{C/W}$
Thermal Resistance, Junction to Ambient	R_{thJA}		-	-	40.0	

* Pulse width is limited by $T_{j,max}$

1200V SiC MOSFET

GP2T040A120U

Static Electrical Characteristics, at $T_j=25^\circ\text{C}$, unless otherwise specified

Characteristics	Symbol	Conditions	Values			Unit
			min.	typ.	max.	
Drain-Source Breakdown Voltage	BV_{DSS}	$I_{DS}=1\text{mA}$	1200	-	-	V
Zero Gate Voltage Drain Current	I_{DSS}	$V_{DS}=1200\text{V}, V_{GS}=0\text{V}$	-	0.1	1.0	μA
		$V_{DS}=1200\text{V}, V_{GS}=0\text{V}, T_j=175^\circ\text{C}$	-	1	-	
Gate-Source Leakage Current	I_{GSS+}	$V_{GS}=20\text{V}, V_{DS}=0\text{V}$	-	<+10	100	nA
	I_{GSS-}	$V_{GS}=-5\text{V}, V_{DS}=0\text{V}$	-	>-10	-100	
Gate Threshold Voltage	$V_{GS(th)}$	$V_{GS}=V_{DS}, I_{DS}=10\text{mA}$	2	2.4	4	V
		$V_{GS}=V_{DS}, I_{DS}=10\text{mA}, T_j=125^\circ\text{C}$	-	1.8	-	
		$V_{GS}=V_{DS}, I_{DS}=10\text{mA}, T_j=175^\circ\text{C}$	-	1.6	-	
Drain-Source On-Resistance	$R_{DS(on)}$	$V_{GS}=20\text{V}, I_{DS}=40\text{A}$	-	37	52	m Ω
		$V_{GS}=20\text{V}, I_{DS}=20\text{A}$	-	35	45	
		$V_{GS}=20\text{V}, I_{DS}=40\text{A}, T_j=125^\circ\text{C}$	-	56	-	
		$V_{GS}=20\text{V}, I_{DS}=40\text{A}, T_j=175^\circ\text{C}$	-	73	-	
Transconductance	g_{fs}	$V_{DS}=20\text{V}, I_{DS}=40\text{A}$	-	16	-	S
Gate Input Resistance	R_G	$f=1\text{MHz}, V_{AC}=25\text{mV}, \text{D-S Short}$	-	1.9	-	Ω

AC Electrical Characteristics, at $T_j=25^\circ\text{C}$, unless otherwise specified

Characteristics	Symbol	Conditions	Values			Unit
			min.	typ.	max.	
Input Capacitance	C_{ISS}	$V_{GS}=0\text{V}, V_{DS}=1000\text{V}, f=200\text{kHz}, V_{AC}=25\text{mV}$	-	3192	-	pF
Output Capacitance	C_{OSS}		-	132	-	
Reverse Transfer Capacitance	C_{RSS}		-	7	-	
Coss Stored Energy	E_{OSS}		-	77	-	
Turn-On Switching Energy	E_{ON}	$V_{DD}=800\text{V}, I_{DS}=40\text{A}, R_{G(ext)}=2.5,$	-	1087	-	μJ
Turn-Off Switching Energy	E_{OFF}	$V_{GS}=-5/+20\text{V}, L=273\mu\text{H},$	-	86	-	
Total Switching Energy	E_{TOT}	$\text{FWD}=\text{GP2T040A120U}$	-	1173	-	
Turn-On Switching Energy	E_{ON}	$V_{DD}=800\text{V}, I_{DS}=40\text{A}, R_{G(ext)}=2.5,$	-	888	-	μJ
Turn-Off Switching Energy	E_{OFF}	$V_{GS}=-5/+20\text{V}, L=273\mu\text{H},$	-	94	-	
Total Switching Energy	E_{TOT}	$\text{FWD}=\text{GP3D020A120A}$	-	982	-	
Turn-On Delay Time	$t_{D(on)}$	$V_{DD}=800\text{V}, I_{DS}=40\text{A},$	-	15	-	ns
Rise Time	t_R	$R_{G(ext)}=2.5, V_{GS}=-5/+20\text{V},$	-	14	-	
Turn-Off Delay Time	$t_{D(off)}$	$L=273\mu\text{H},$	-	22	-	
Fall Time	t_F	$\text{FWD}=\text{GP2T040A120U}$	-	14	-	
Total Gate Charge	Q_G	$V_{DD}=800\text{V}, I_{DS}=40\text{A}, V_{GS}=-5/+20\text{V}$	-	118	-	nC
Gate to Source Charge	Q_{GS}		-	53	-	
Gate to Drain Charge	Q_{GD}		-	10	-	

Body Diode Characteristics, at $T_j=25^\circ\text{C}$, unless otherwise specified

Characteristics	Symbol	Conditions	Values			Unit
			min.	typ.	max.	
Max Continuous Diode Fwd Current	I_S	$V_{GS}=-5\text{V}, T_C=25^\circ\text{C}$	-	-	74	A
Diode Forward Voltage	V_{SD}	$V_{GS}=-5\text{V}, I_{SD}=20\text{A}$	-	3.8	-	V
Reverse Recovery Time	t_{RR}	$I_{SD}=40\text{A}, V_R=800\text{V}, V_{GS}=-5\text{V}, di_F/dt=3.2\text{A/ns}$	-	28	-	ns
Reverse Recovery Charge	Q_{RR}		-	284	-	nC
Peak Reverse Recovery Current	I_{RRM}		-	18	-	A

Typical Performance

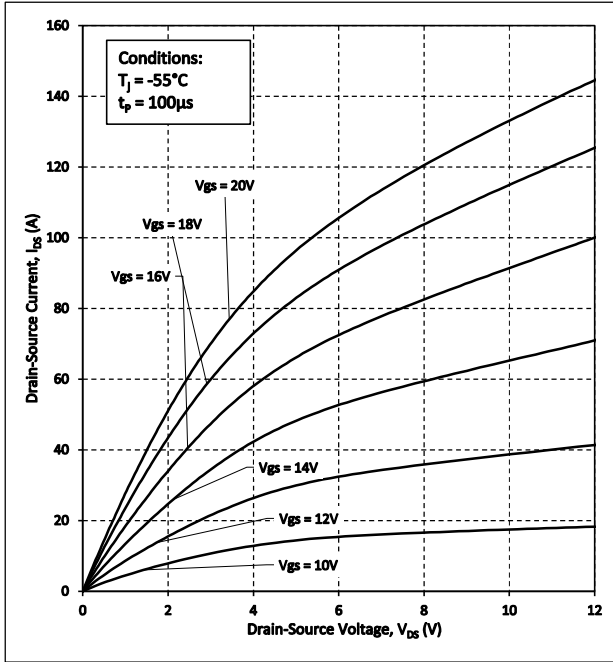

Figure 1. Output Characteristics $T_j = -55^\circ\text{C}$

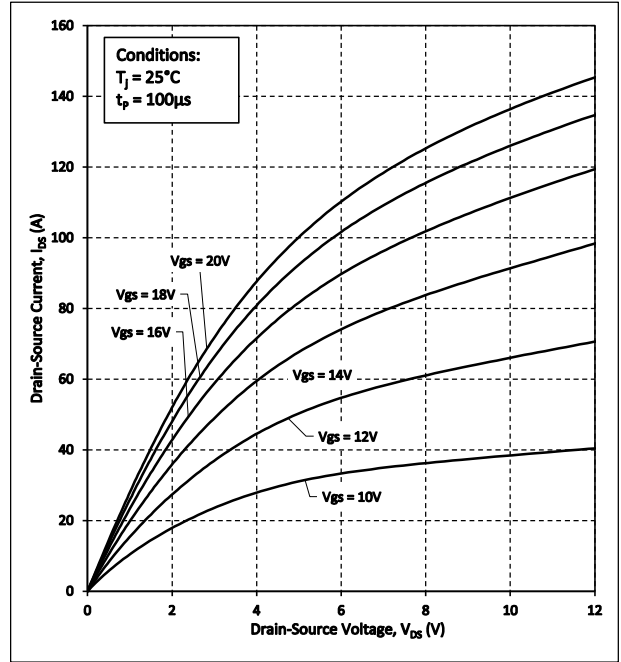

Figure 2. Output Characteristics $T_j = 25^\circ\text{C}$

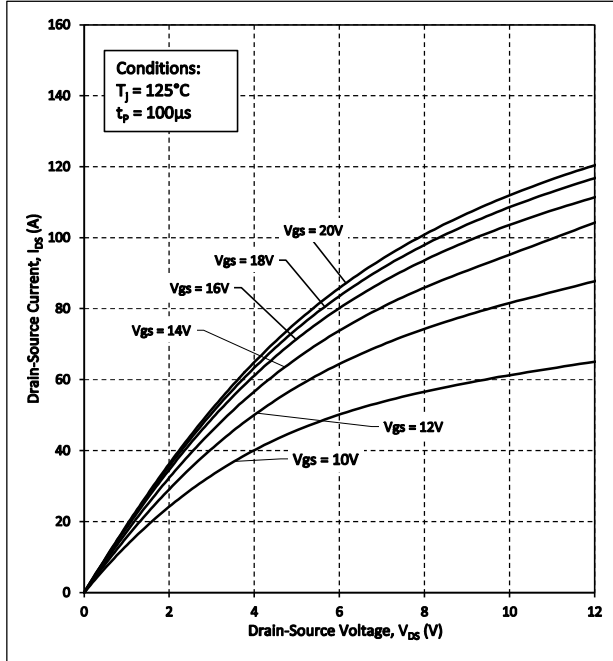

Figure 3. Output Characteristics $T_j = 125^\circ\text{C}$

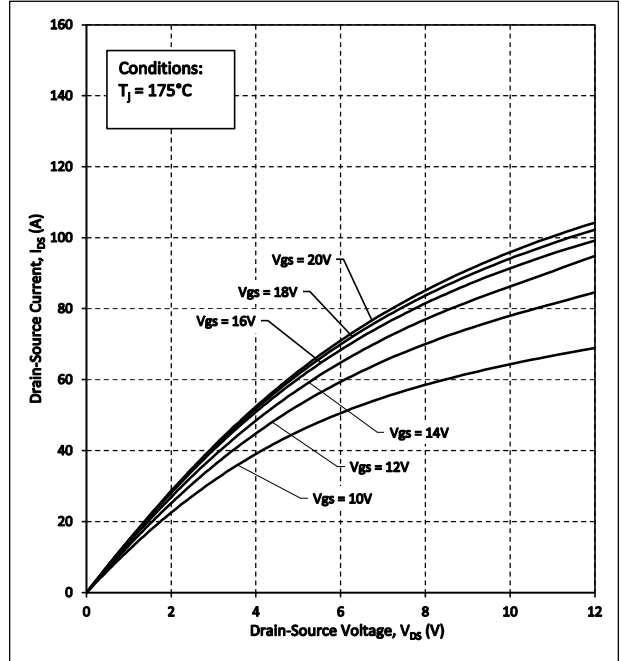

Figure 4. Output Characteristics $T_j = 175^\circ\text{C}$

1200V SiC MOSFET

GP2T040A120U

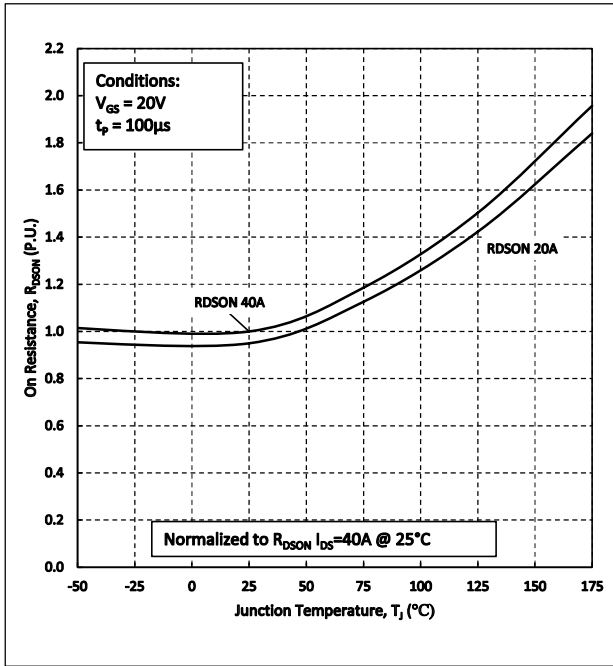

Figure 5. Normalized On-Resistance vs. Temperature

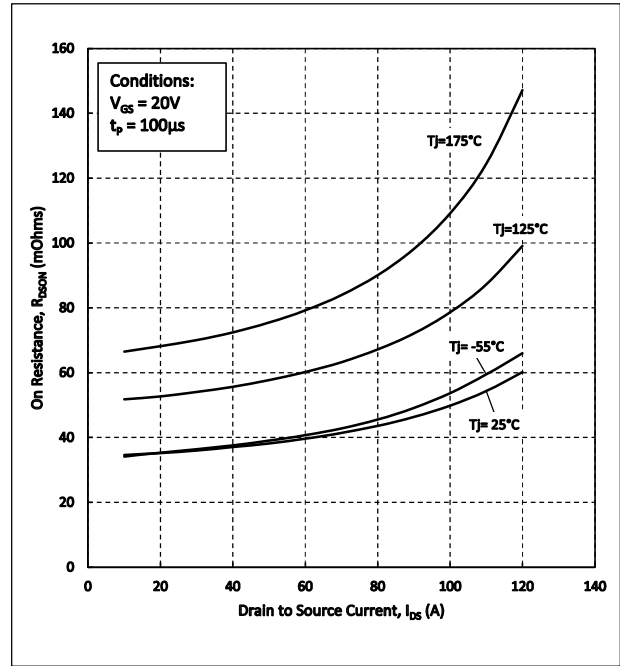

Figure 6. On-Resistance vs. Drain Current For Various Temperature

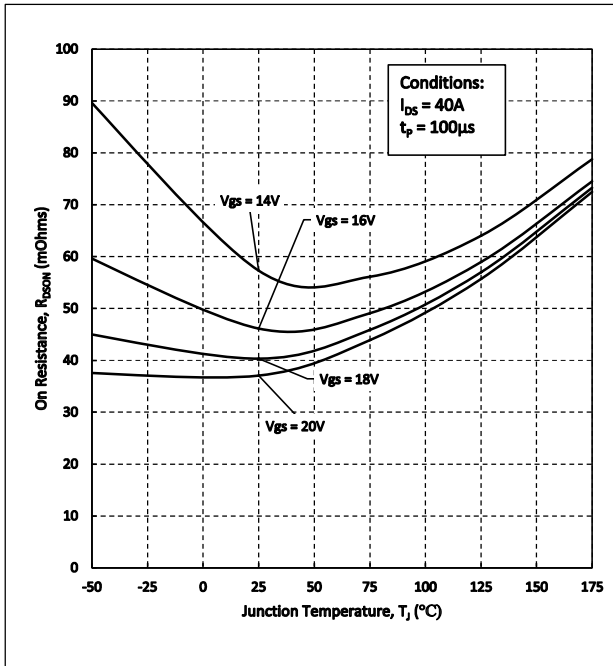

Figure 7. On-Resistance vs. Temperature For Various Gate Voltages

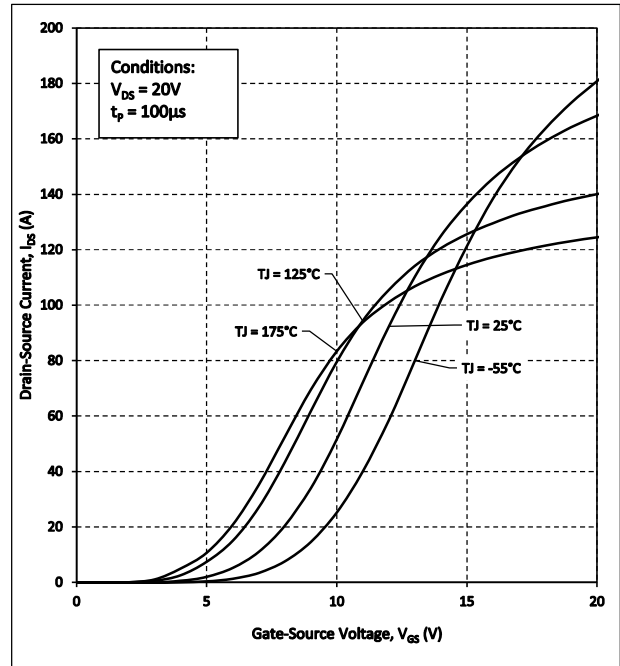

Figure 8. Transfer Characteristic for Various Junction Temperatures

1200V SiC MOSFET

GP2T040A120U

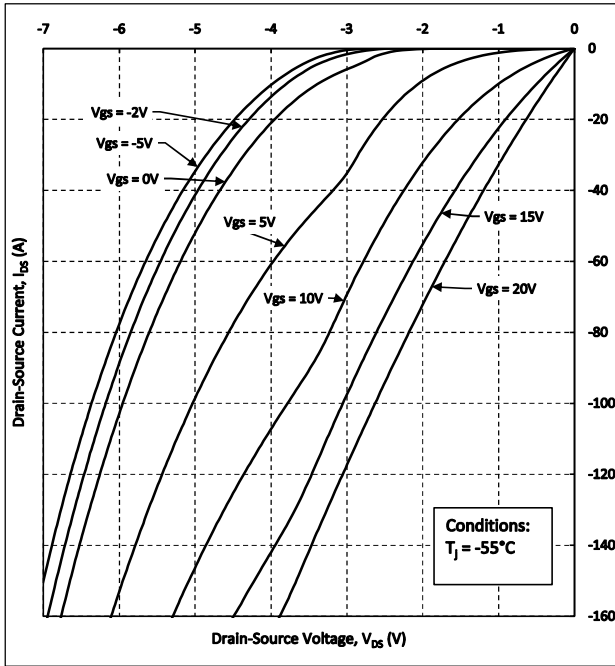

Figure 9. Body Diode Characteristics at $T_j = -55^\circ\text{C}$

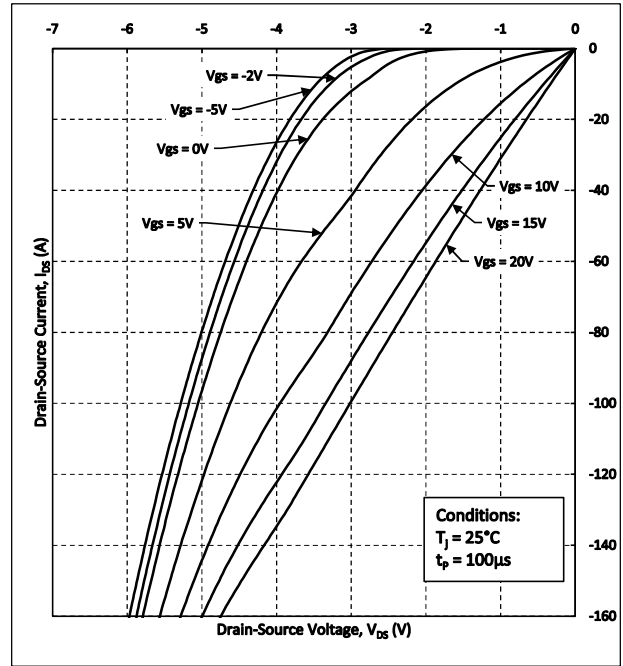

Figure 10. Body Diode Characteristics at $T_j = 25^\circ\text{C}$

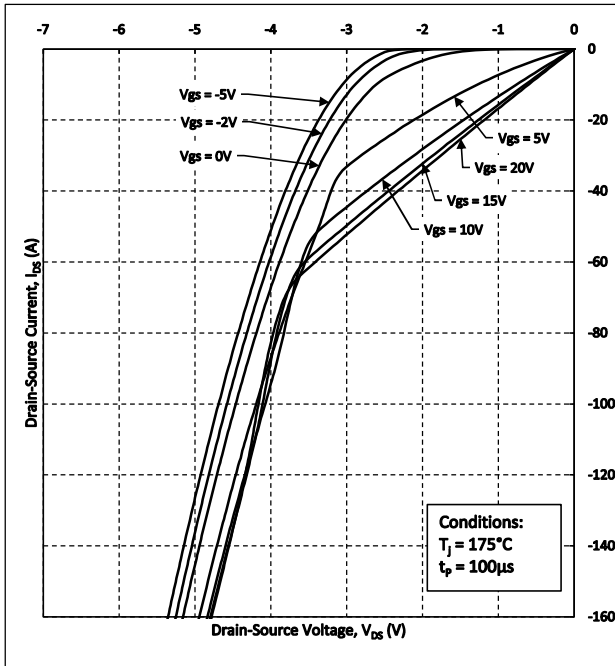

Figure 11. Body Diode Characteristics at $T_j = 175^\circ\text{C}$

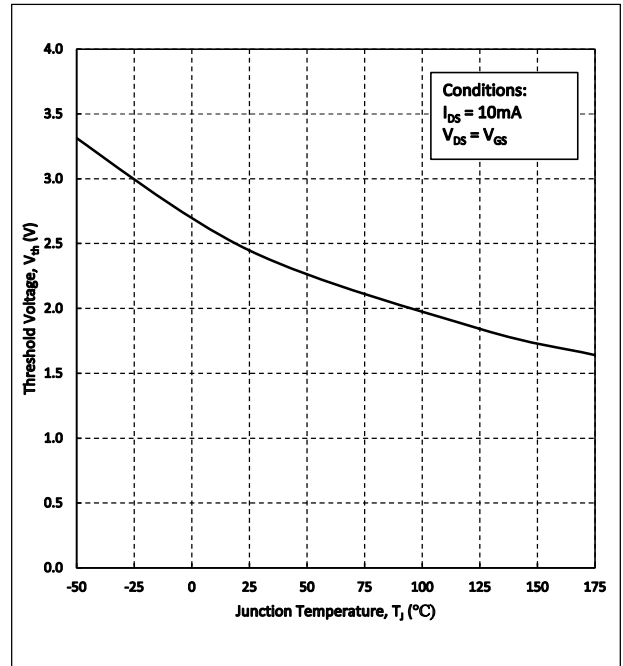

Figure 12. Threshold Voltage vs. Temperature

1200V SiC MOSFET

GP2T040A120U

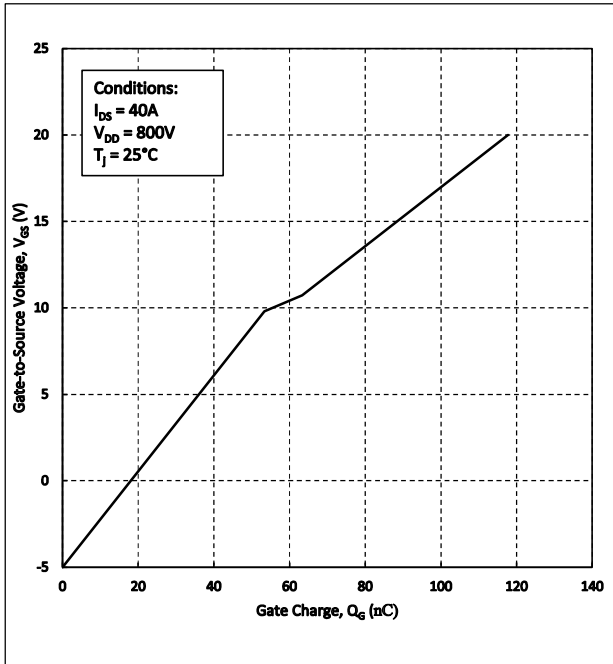

Figure 13. Gate Charge Characteristics

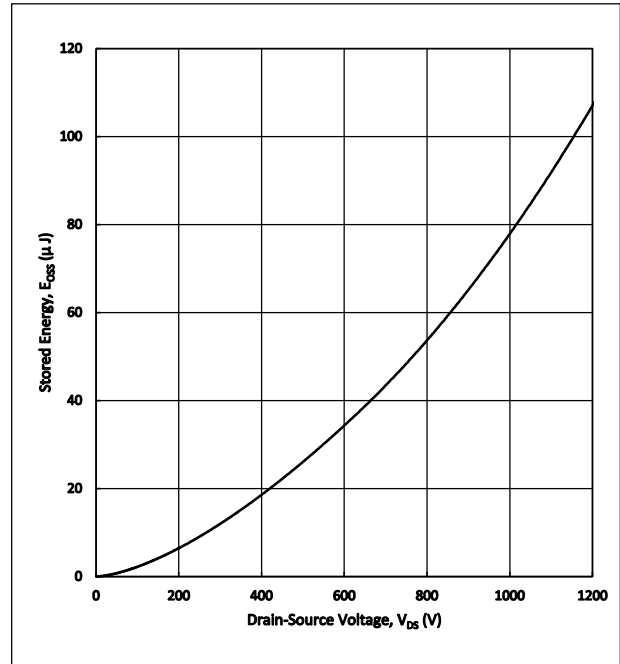

Figure 14. Output Capacitor Stored Energy

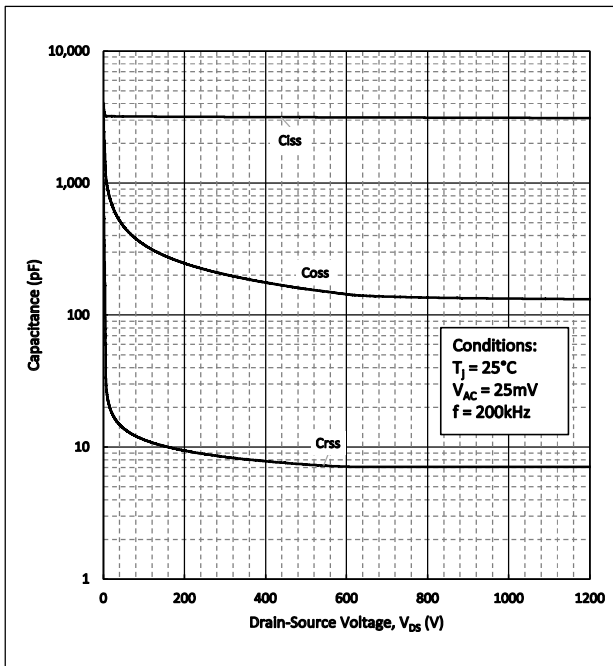

Figure 15. Capacitance vs Drain-Source Voltage

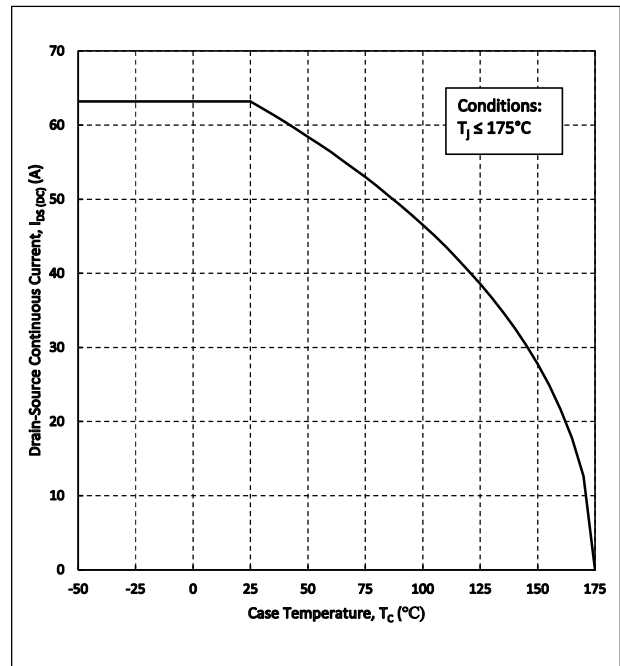

Figure 16. Continuous Drain Current Derating vs. Case Temperature

1200V SiC MOSFET

GP2T040A120U

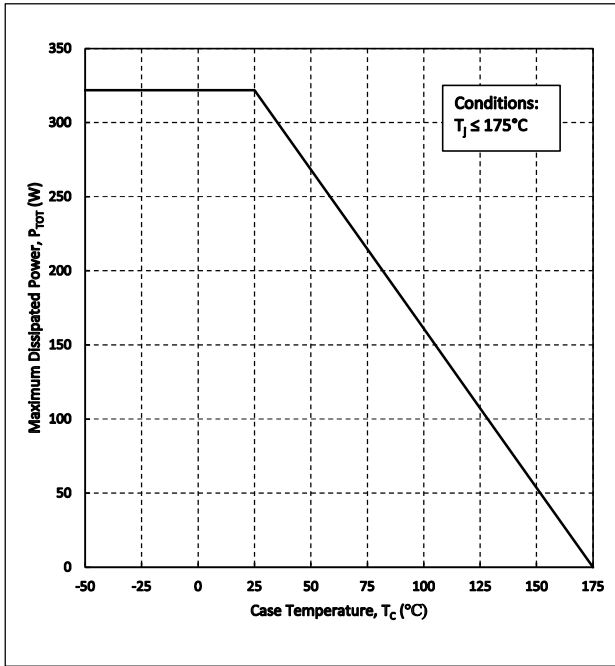

Figure 17. Maximum Power Dissipation Derating vs Case Temperature

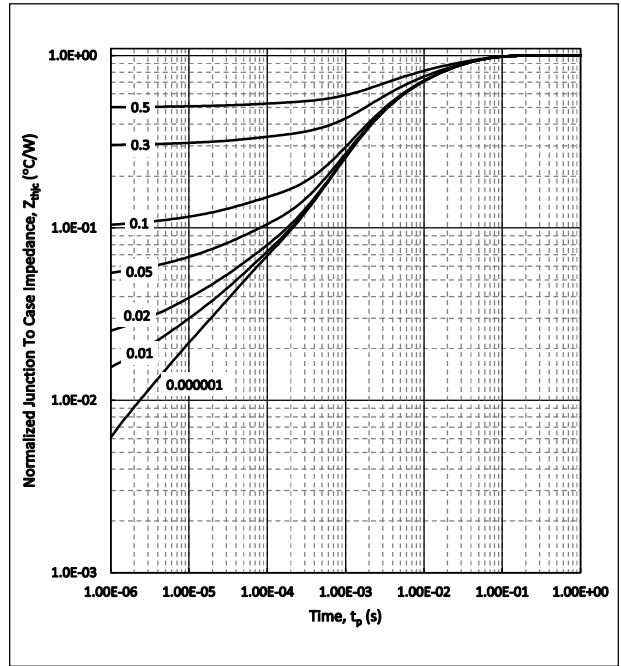

Figure 18. Transient Thermal impedance (Junction to Case)

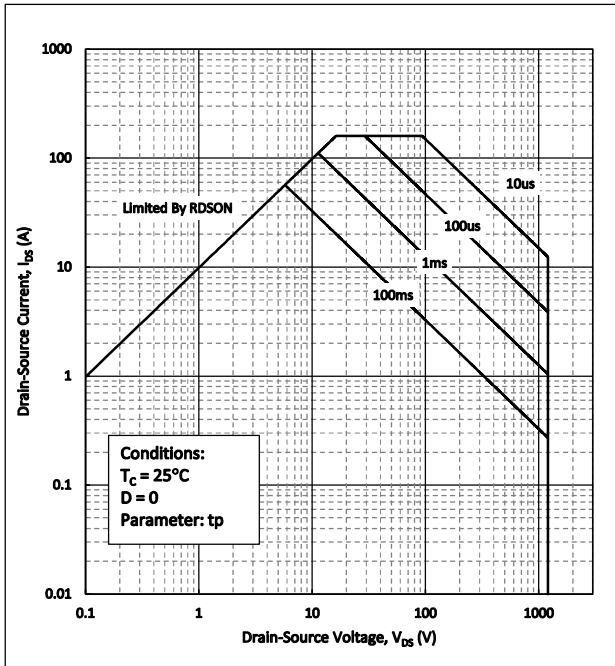

Figure 19. Safe Operating Area

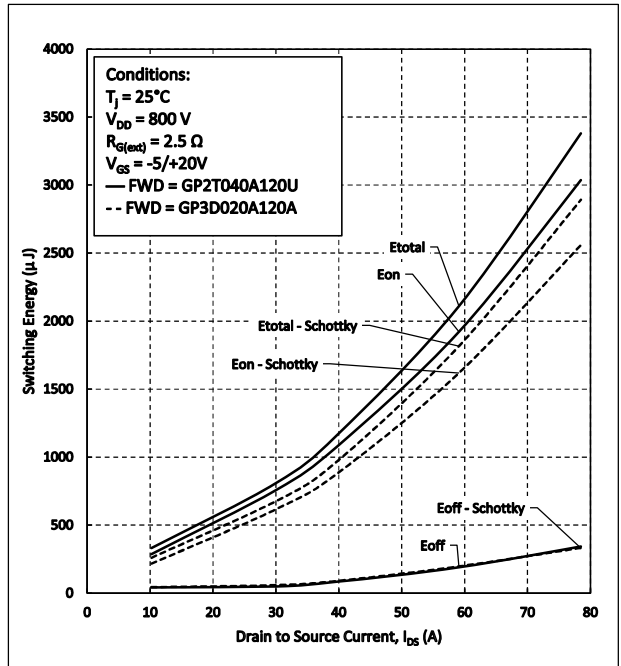

Figure 20. Clamped Inductive Switching Energy vs. Drain Current

1200V SiC MOSFET

GP2T040A120U

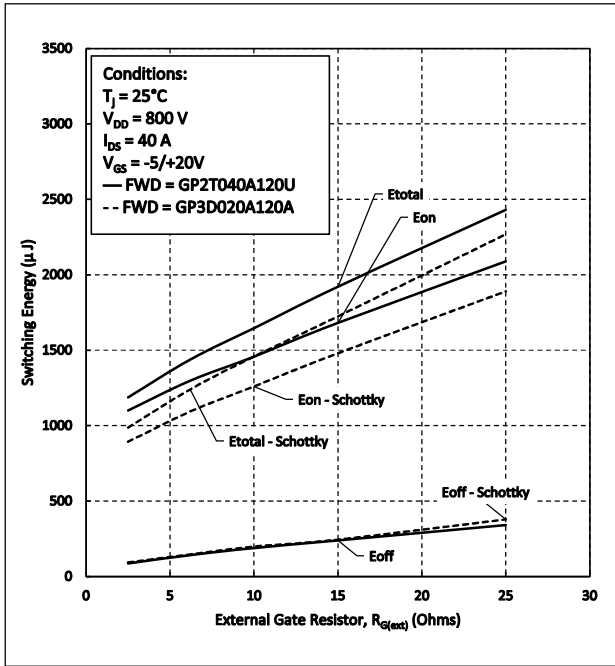

Figure 21. Clamped Inductive Switching Energy vs. $R_{G(ext)}$

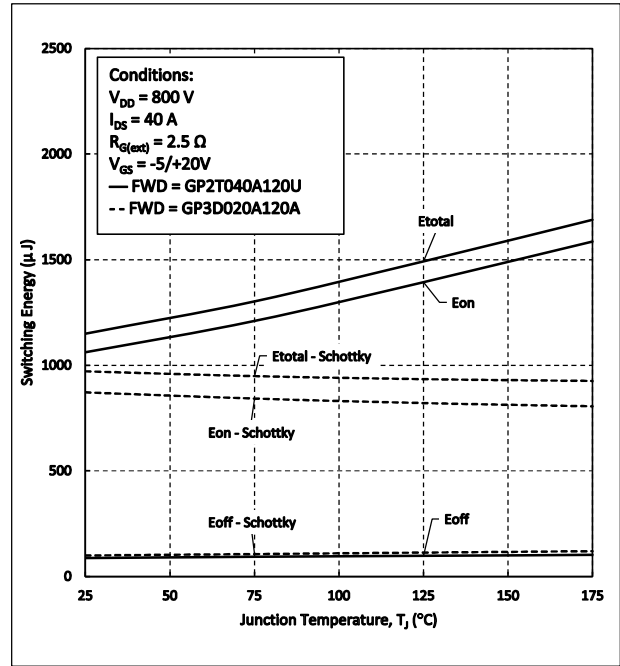

Figure 22. Clamped Inductive Switching Energy vs. Temperature

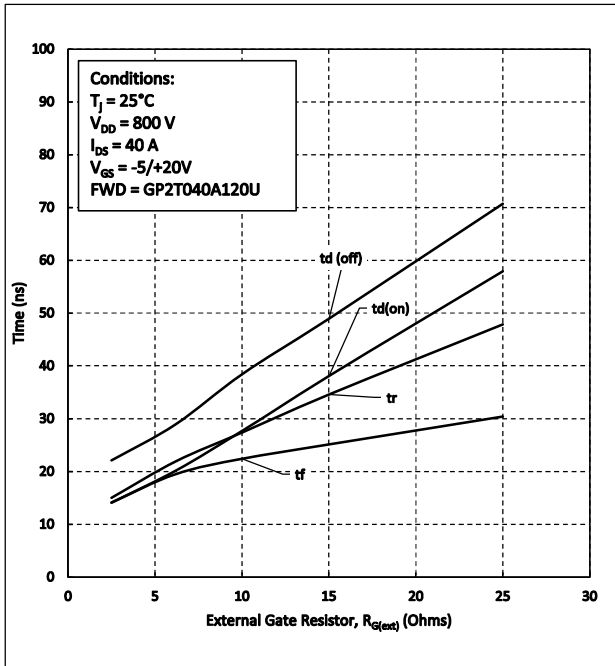

Figure 23. Switching Times vs $R_{G(ext)}$

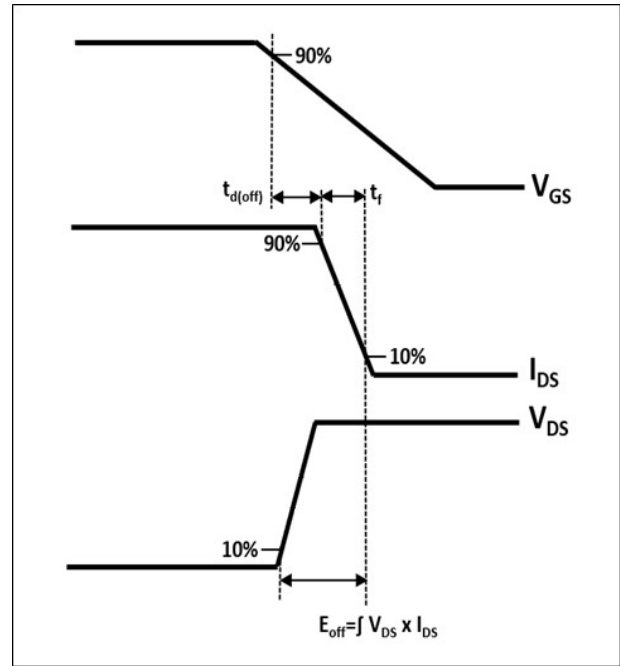

Figure 24. Turn-off Transient Definitions

1200V SiC MOSFET

GP2T040A120U

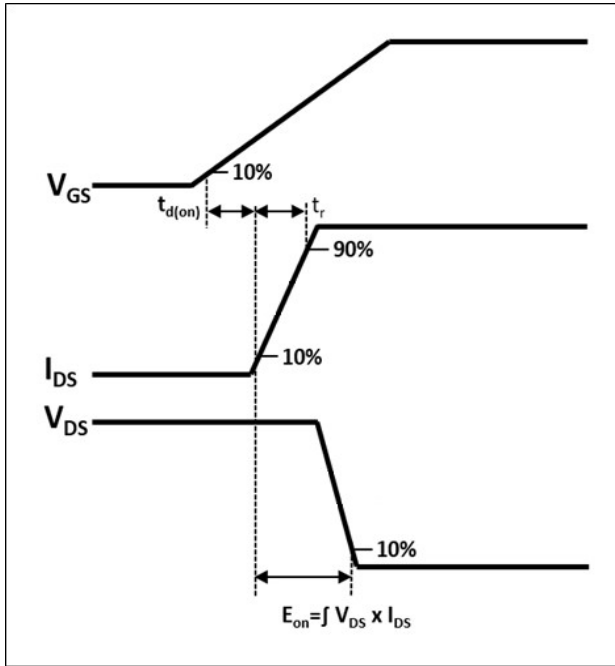

Figure 25. Turn-on Transient Definitions

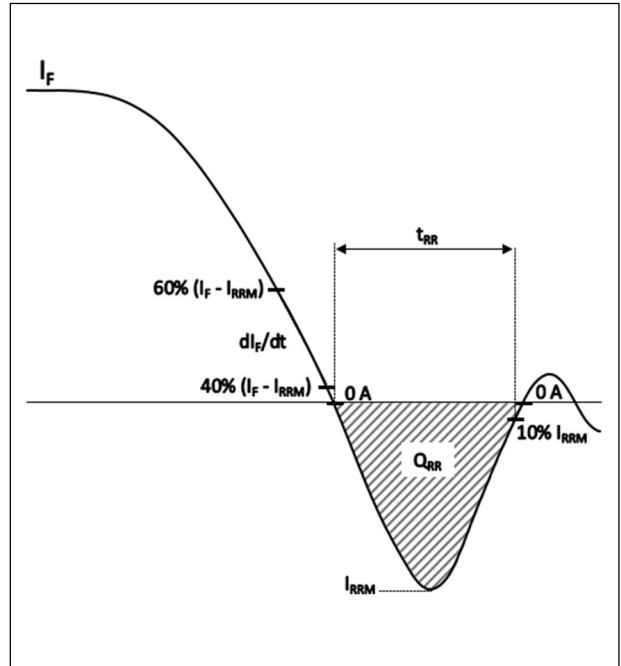
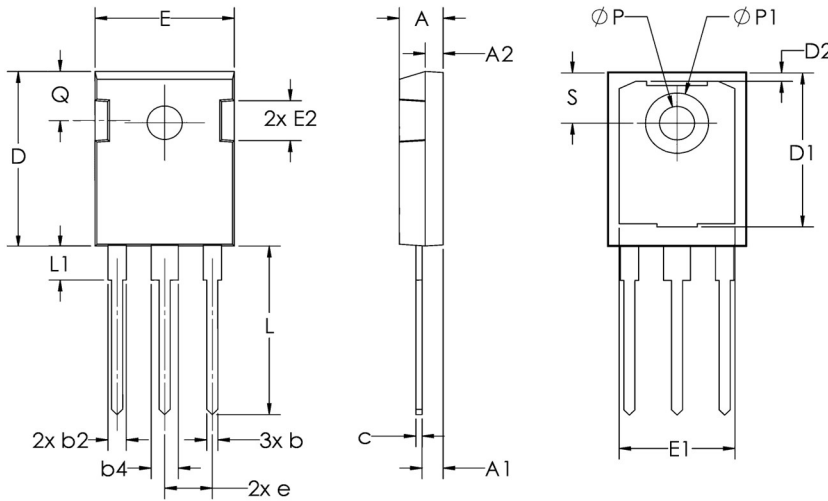

Figure 26. Reverse Recovery Definitions

Package Dimensions TO-247-3L



Sym	Millimeters		Inches	
	Min	Max	Min	Max
A	4.70	5.31	0.185	0.209
A1	2.21	2.59	0.087	0.102
A2	1.50	2.49	0.059	0.098
b	0.99	1.40	0.039	0.055
b2	1.65	2.39	0.065	0.094
b4	2.59	3.43	0.102	0.135
c	0.38	0.89	0.015	0.035
D	20.80	21.46	0.819	0.845
D1	13.08	17.65	0.515	0.695
D2	0.51	1.35	0.020	0.053
E	15.49	16.26	0.610	0.640
E1	13.46	14.16	0.530	0.557
E2	3.43	5.49	0.135	0.216
e	5.44 BSC		0.214 BSC	
L	19.81	20.32	0.780	0.800
L1	4.10	4.50	0.161	0.177
ØP	3.56	3.66	0.140	0.144
ØP1	7.06	7.39	0.278	0.291
Q	5.39	6.20	0.212	0.244
S	6.04	6.30	0.238	0.248

Notes

RoHS Compliance

The levels of RoHS restricted materials in this product are below the maximum concentration values (also referred to as the threshold limits) permitted for such substances, or are used in an exempted application, in accordance with EU Directive 2011/65/EC (RoHS2), as implemented March, 2013. RoHS Declarations for this product can be obtained from the Product Documentation sections of www.SemiQ.com.

REACH Compliance

REACH substances of high concern (SVHC) information is available for this product. Since the European Chemicals Agency (ECHA) has published notice of their intent to frequently revise the SVHC listing for the foreseeable future, please contact our office at SemiQ Headquarters in Lake Forest, California to insure you get the most up-to-date REACH SVHC Declaration. REACH banned substance information (REACH Article 67) is also available upon request.

SemiQ Inc., reserves the right to make changes to the product specifications and data in this document without notice. SemiQ products are sold pursuant to SemiQ's terms and conditions of sale in place at the time of order acknowledgement.

This product has not been designed or tested for use in, and is not intended for use in, applications implanted into the human body nor in applications in which failure of the product could lead to death, personal injury or property damage, including but not limited to equipment used in the operation of nuclear facilities, life-support machines, cardiac defibrillators or similar emergency medical equipment, aircraft navigation or communication or control systems, or air traffic control.

SemiQ makes no warranty, representation or guarantee regarding the suitability of its products for any particular purpose, nor does SemiQ assume any liability arising out of the application or use of any product or circuit, and specifically disclaims any and all liability, including without limitation special, consequential or incidental damages. Buyer is responsible for its products and applications using SemiQ products.

To obtain additional technical information or to place an order for this product, please contact us. The information in this datasheet is provided by SemiQ. SemiQ reserves the right to make changes, corrections, modifications, and improvements of datasheet without notice.