











Connected Industrial Sensor Solution | CISS

The Robust Acceleration, Vibration & Condition Detector

ART NO | 0273.600.044

The CISS is a multi-sensor device detecting acceleration and vibration as well as environmental conditions. The robust housing and compact size makes it perfectly suitable for industrial retrofit applications such as condition monitoring and predictive maintenance. Configuring the device enables the customer to address a broad variety of use cases by interpreting the sensor data by smart algorithms.

BUILT-IN SENSORS

							
Accelerometer	Temperature sensor	Humidity sensor	Light sensor	Gyroscope	Magnetometer	Pressure sensor	Acoustic sensor

SCOPE OF DELIVERY

- ▶ CISS device
- ▶ USB cable (2m)
- ▶ Fasteners (2 screws, 2 washers, and 2 magnetic bases)
- ▶ Quick Start Guide



OPERATING CONDITIONS

Reference	Range
Operating temperature range	-20 °C ... +80 °C
Humidity range	10% rH ... 100 % rH (non condensing)
Pressure range	300 hPa... 1100 hPa
Supply voltage	Standard USB Power

TARGET MARKETS

European Union Countries: AT, BE, BG, CY, CZ, DE, DK, EE, ES, FI, FR, GR, HR, HU, IE, IT, LT, LU, LV, MT, NL, PL, PT, RO, SE, SI, SK

And: AU, CH, CN, CO, GB, IN, IS, JP, KE, KR, LI, MY, NO, SG, TR, US, VN

Further on request

MEASUREMENT RANGE, ACCURACY, RESOLUTION

Sensor	Measurement Range	Accuracy ¹	Resolution
Acceleration	± 2, 4, 8, 16 g (14 bit resolution)	± 50 mg	1mg (± 2, 4, 8, 16g)
Gyroscope	± 2000 °/s	± 1 °/s	1 °/s
Magnetometer	± 1300 µT (X, Y-Axis); ± 2500 µT (Z-Axis)	0.06 x M ± 25µT	1.0 µT
Temperature	-20 °C ... +80 °C	max. ±2 °C + 3% T °C	0.1 °C
Humidity	20 – 90% (non-condensing)	max. ±7% at +20 °C; max. ±10% at -20 °C	0.01 % rH
Pressure	300 - 1100 hPa	± 1.5 hPa	0.01 hPa
Light	0 ... 2112800 Lux	± 15 %	1 Lux

SAMPLING RATES

Sensorw	Sampling rate	Hints
Acceleration	≤ 100 Hz	▶ Special mode Accelerometer: 2kHz streaming over USB (other sensors are deactivated)
Gyroscope	≤ 100 Hz	
Magnetometer	≤ 100 Hz	▶ BLE sampling rate depends on the quality of the BLE connection; Acoustic sensor data can only be transferred via BLE
Temperature	≤ 1 Hz	
Humidity	≤ 1 Hz	
Pressure	≤ 1 Hz	
Light	≤ 1 Hz	
Acoustic	≤ 1 Hz	



BOSCH

Invented for life

DEVICE SPECIFICATION & MAIN COMPONENTS

Reference	Information
Weight	CISS device: 34 g; cable: 60 g; fastening set (2 magnets, 2 screws, 2 washers): 19 g
Power supply	Standard USB Power
Bluetooth frequency band	2400 – 2483.5 MHz
Enclosure protection class	IP54
Microcontroller	32-Bit microcontroller (ARM Cortex M3), 1MB Flash, 128 kB RAM
Memory capacity	2 MB

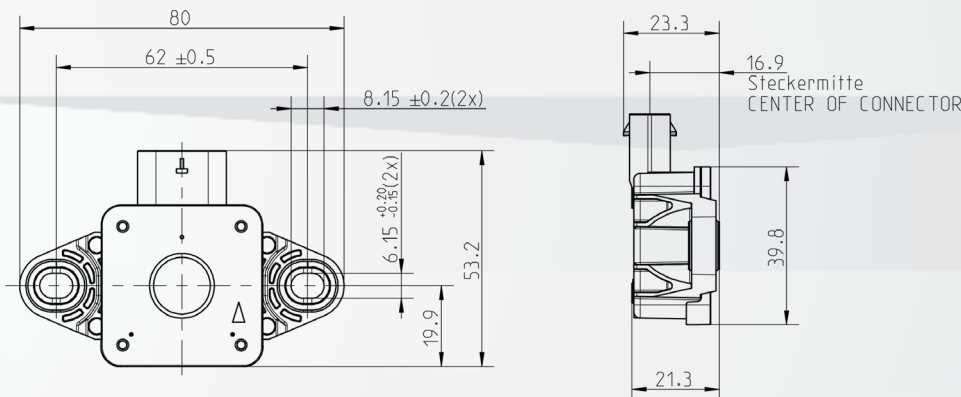

COMMUNICATION INTERFACE

Wireless / Wired

Bluetooth low energy 4.0

USB 2.0

USER INTERFACE

Virtual CISS App

Free smartphone demo application for configuration, read out and visualization

Further available to Download

Example Python Script

Windows Driver

Firmware Updates



GET IN CONTACT WITH US!

E-Mail: support@bosch-connectivity.com

Website: www.bosch-connectivity.com/CISS



Technical data subject to modification without notice.

© Bosch Connected Devices and Solutions GmbH 2020. All rights reserved, also regarding and disposal, exploitation, reproduction, editing, distribution, as well as in the event of application for industrial property rights. July, 08, 2020