

电源产品规格书

Power supply product specification

产品名称: 120W—LED 驱动条形电源

Product Name: 120W—LED Strip Power Supply

产品型号: AD-EL-120/2401200-B

Product Item: AD-EL-120/2401200-B

Shanghai Edge Light Industry Co.,LTD.

TEL:+86-21-64412288

FAX:+86-21-64412266

E-mail: info@edgelight.com



1、产品简介 Product Introductions

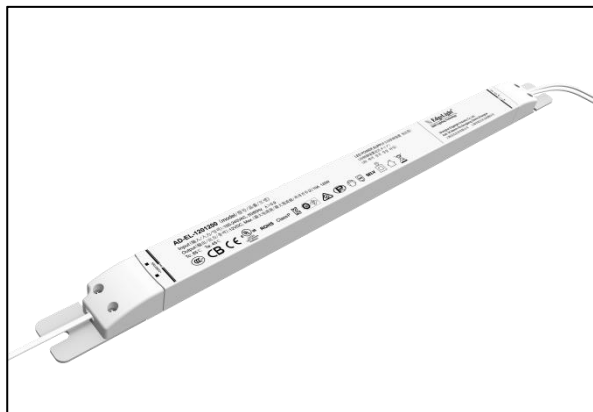

AD-EL-1201200-B

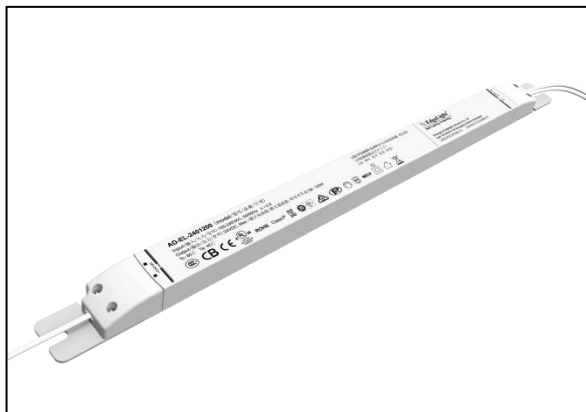

AD-EL-2401200-B

- 电气类型：隔离电源

Electrical type: Isolated power supply

- 功能说明：全电压（半电压）无频闪

Function description: Full voltage (half voltage) without stroboscopic

- 产品特性：SELV 全电压范围内工作，高 PF 值、高性能，高效率，可以连接我司 three-in-one 调光控制
器构成 pwm/0-10v/resistor 调光电源

Product features: SELV working in full voltage range, high PF value, high performance, high efficiency, can be connected to our three-in-one dimming controller to form pwm/0-10v/resistor dimming power supply

- 应用领域：LED 照明领域

Application area: LED lighting field

- 质保：参见产品寿命曲线

Warranty: To refer product life curve

- 认证：

Certification:            

2、电气规格 Electrical specifications

指标 Index	型号全称 Full name of model	AD-EL-1201200-B	AD-EL-2401200-B
输出特性 Output characteristic	输出电压 Output voltage	12V	24V
	输出电流 Output current	10A	5A
	纹波电压+噪音 (峰峰值) Ripple voltage + noise(peak-to-peak)	392mV (Vp-p)	404mV (Vp-p)
	电压精度 Voltage accuracy	±2%	±2%
	启动时间 (最大值) Start time (maximum)	< 240ms	< 300ms
	温度漂移 Temperature drift	±0.03%/°C (0-60°C)	±0.03%/°C (0-60°C)
	输出线性调整率 Output linear adjustment rate	±3%	±2%
	负载调整率 Load regulation rate	±2%	±2%
	保持时间 Preserve time	200ms	200ms
	输入特性 Input characteristics	输入电压 Input voltage	100VAC~240VAC
输入频率 Input frequency		50HZ/60HZ	50HZ/60HZ
输入电流 (最大值) Input current (maximum)		1.4A	1.4A
漏电流 Leakage current		0.8mA	0.8mA

	总谐波 Total harmonic	< 30%	< 30%
	功率因数 Power factor	> 0.9	> 0.9
	效率 Efficiency	91%	92%
	浪涌电流 Surge current	冷启动 40A @230Vac Cold start 40A @230Vac	
	空载功耗/待机功耗 No-load power consumption / standby power consumption	1.5W	1.5W
保护特性 Protection characteristics	过流保护 Over current protection	15A	7.5A
	短路保护 Short circuit protection	有 yes	有 yes
环境描述 Environmental description	工作温度 Operating temperature	Tcase = -20°C-50°C	
	工作湿度 Working humidity	20-95%RH, 无冷凝	
	存储温度-湿度 Storage temperature-humidity	-20°C-50°C 10-95%RH	
	大气压强 Atmospheric pressure	86-106KPa	
安全及规范 Safety and regulation	认证 Certification	CE、CB、UL-8750+Class P	
	耐压 Pressure resistant	I/P-O/P:3KVAC	
	绝缘阻抗 Insulation resistance	I/P-O/P, I/P-FG,O/P-FG:100MΩ/500Vdc/70%RH	

	电磁兼容干扰 Electromagnetic compatibility interference	符合 EN55015、EN61000-3-2、EN61000-3-3, EN61547 标准要求 Meets EN55015, EN61000-3-2, EN61000-3-3, EN61547 requirements	
	电磁兼容抗干扰 Electromagnetic compatibility anti-jamming	EN61000-3-2, EN61000-3-3, EN61547 标准要求 EN61000-3-2, EN61000-3-3, EN61547 standard requirements	
其他 others	包装 Package	净重量约 261g,包装: 330g*60pcs,19.8kg The net weight is about 261g, packaging: 330g*60pcs, 19.8kg	净重量 261g,包装: 330g*60pcs,19.8kg Net weight 261g, packaging: 330g*60pcs, 19.8kg
	尺寸 size	417*30*25mm	
	IP 等级说明 IP Level description	IP20	
	质保说明 Warranty description	≥2 年, 参见寿命曲线 ≥ 2 years, refer to life curve	≥2 年, 参见寿命曲线 ≥ 2 years, refer to life curve
	测试设备 Test Equipment	LCR METER: TH2830, fluke 数字万用表, 电子负载: PEL-3041, 交流源: 远方 PPS1010、功率分析仪: Ainuo, 数字示波器: SDS3034E, 传导分析仪: 远方 LS-3、FFT3030, 接地电阻测试仪: MS2520C 型, 耐压测试仪: TH9320, 烤箱, 电脑监控老化测试系统。 LCR METER: TH2830, fluke digital multimeter, electronic load: PEL-3041, AC source: remote PPS1010, power analyzer: Ainuo, digital oscilloscope: SDS3034E, conduction analyzer: remote LS-3, FFT3030, ground resistance tester: MS2520C Type, withstand voltage tester: TH9320, oven, computer monitoring aging test system.	
测试说明 Test instruction	纹波电压测试方法: 示波器探头设置 AC, 带宽设置 20M, 在输出端并接 10uF 电解电容/100nF 贴片电容。除温升测试项目外, 其余测试温度均在 25°C, 230Vac 条件下。 Ripple voltage test method: The oscilloscope probe is set to AC, the bandwidth is set to 20M, and 10uF electrolytic capacitor/100nF chip capacitor is connected at the output end. Except for the temperature rise test project, the rest of the test temperature is at 25°C, 230 Vac.		

3、产品寿命 Product life span

在一个密闭空间内，当环境温度达到 30°C, 40°C, 50°C, 60°C, 70°C时，计算产品使用寿命

In a confined space, when the ambient temperature reaches 30 ° C, 40 ° C, 50 ° C, 60 ° C, 70 ° C, Calculate product life

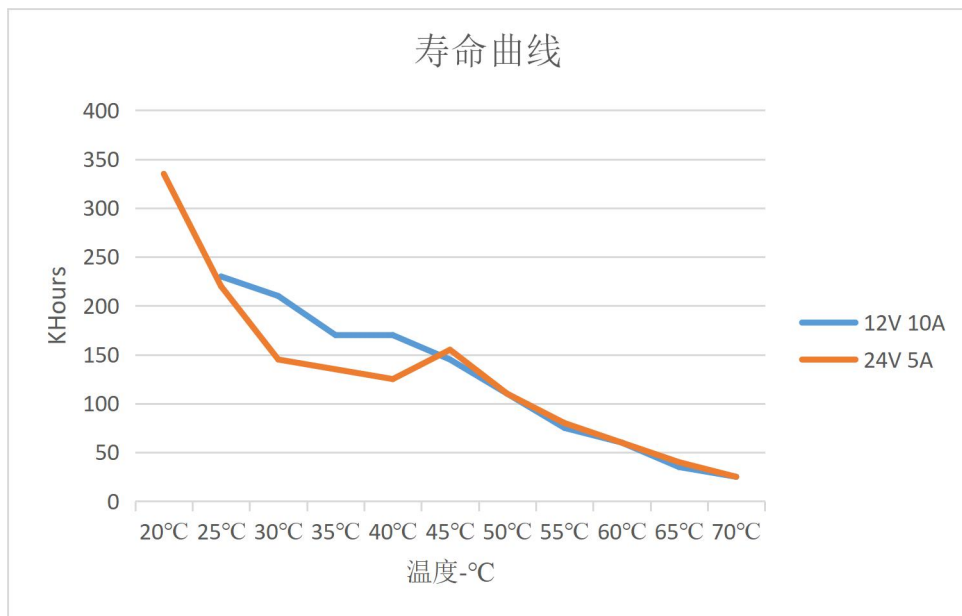

4、输出负载 VS 环境温度

Output load VS ambient temperature

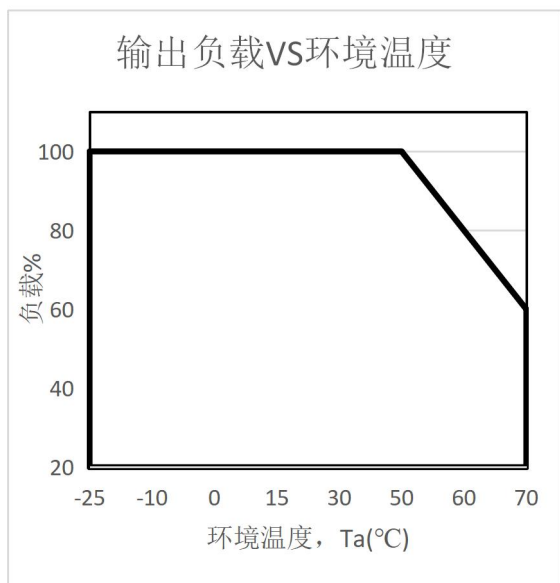

5、静态特性曲线

Static characteristic curve

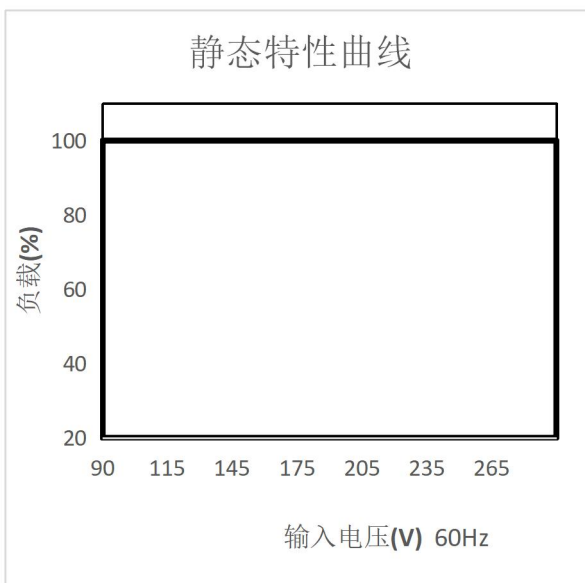

6、功率因素特性曲线

Power factor characteristic curve

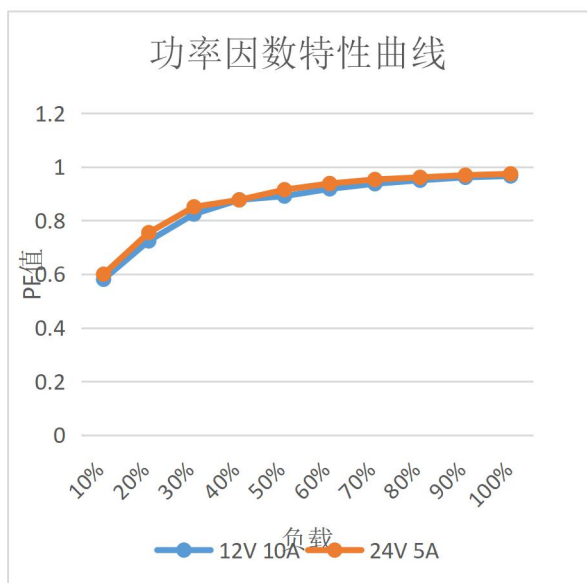

7、总谐波失真特性曲线

Total harmonic distortion characteristic curve

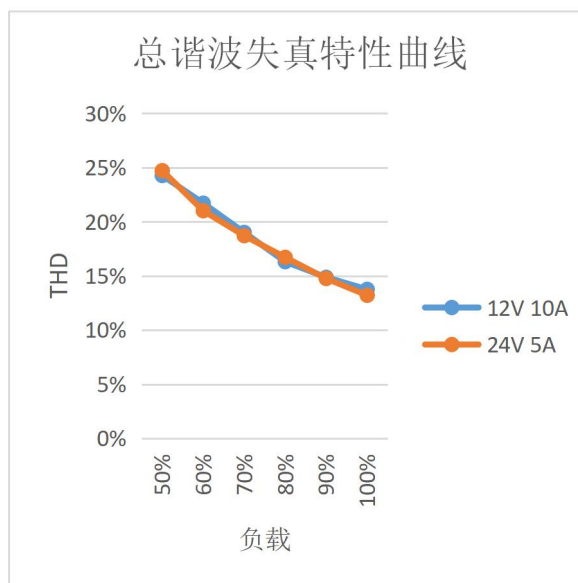

8、效率 VS 负载

Efficiency vs load

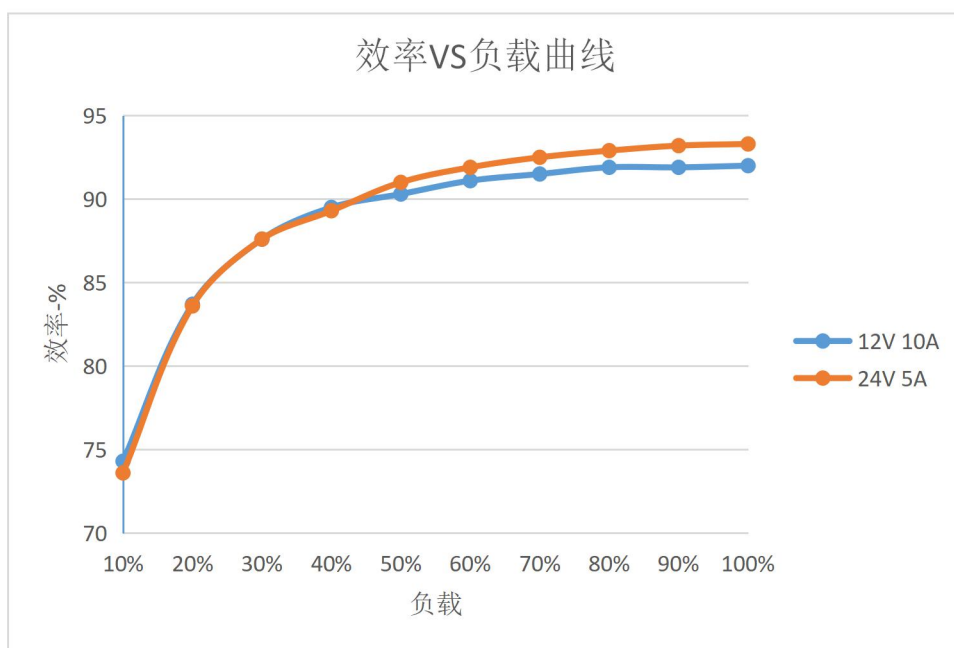

9、结合调光器使用连接图

Use the connection diagram with the dimmer

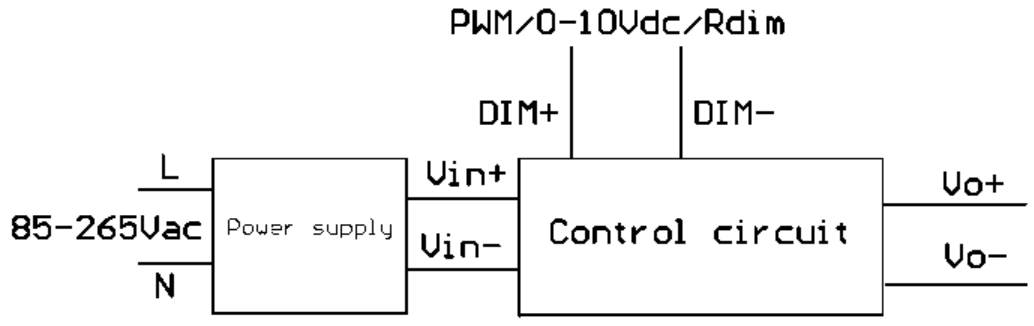

三合一调光功能:

在 DIM+和 DIM-间连接一个电阻或连接 0-10V 直流电压或 PWM 信号，即可调整输出恒电流的数值。
Vo+和 Vo-之间直接连接 12V 或者 24V 的 LED 灯条或灯带。

Three-in-one dimming function:

The output constant current value can be adjusted by connecting a resistor or connecting a 0-10V DC voltage or PWM signal between DIM+ and DIM-.
A 12V or 24V LED strip or strip is directly connected between Vo+ and Vo-.

实物图连接如下:

The material is connected in the picture as follows:



调光功能说明:

Dimming function description:

1.0-10V 调光: 调光范围 0%-100%

0-10V light modulator: light modulator range 0%-100%

调光电压 Dimming voltage	0V	1V	2V	3V	4V	5V	6V	7V	8V	9V	10V	OPEN
额定电流百分比 Rated current percentage	关断	12.5%	17%	30%	40%	49%	61%	73%	80%	83%	91%	95%-105%

2.电阻调光: 调光范围 10%-100%, 电阻阻值范围: 2KΩ-20kΩ

Resistance dimming: Dimming range 10%-100%, resistance range: 2KΩ-20kΩ

调光电阻阻值 Light modulator resistance	2kΩ	4kΩ	6kΩ	8kΩ	10kΩ	12kΩ	14kΩ	16kΩ	18kΩ	20kΩ	OPEN
额定电流百分比 Rated current percentage	6%	17%	26%	37%	46%	57%	68%	79%	95%	99.5%	95%-105%

3.PWM 调光: 调光范围 10%-100%, 采用幅值为 10V, 频率为 500Hz-5KHz 的 PWM 信号调节

PWM dimming: dimming range 10%-100%, PWM signal adjustment with amplitude of 10V and frequency of 500Hz-5KHz

PWM 信号占空比 PWM signal duty cycle	10%	20%	30%	40%	50%	60%	70%	80%	90%	100%	OPEN
额定电流百分比 Rated current percentage	5%	17%	30%	40%	50%	60%	70%	80%	90%	100%	95%-105%



8、外观尺寸 Exterior dimension

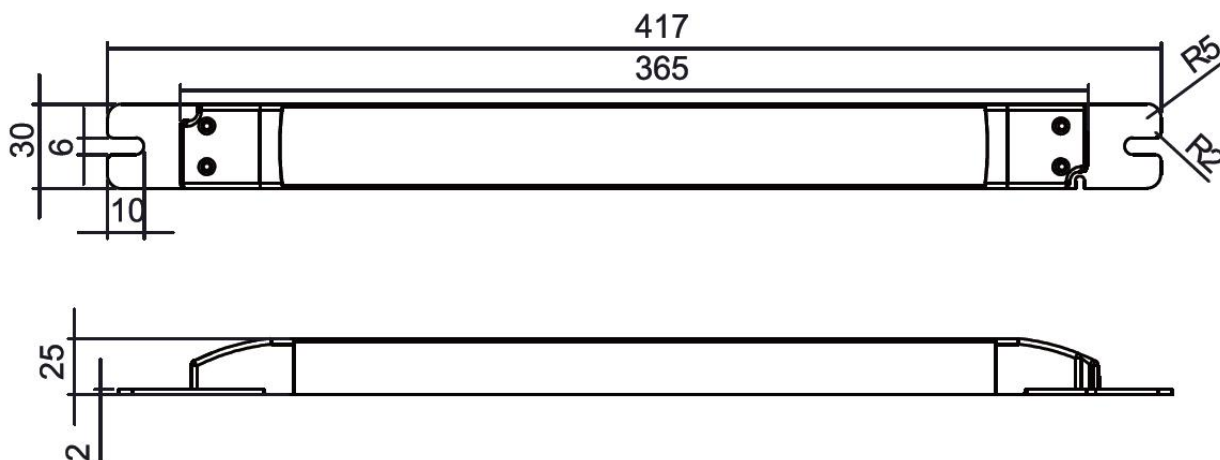

9、铭牌 Label

<p>AD-EL-1201200 (model/型号/品番/모델) Input (输入/入力/입력): 100-240VAC, 50/60Hz $\lambda > 0.9$ Output (输出/出力/출력): 12VDC, Max. (最大电流值/最大電流値/최대전류값) 10A 120W Tc: 85°C Ta: 45°C</p>	<p>LED POWER SUPPLY (LED控制装置 恒压型/ LED制御装置定圧タイプ/ LED 제어 장치 정압 타입)</p>	<p>EdgeLight Shift Lighting Technology™</p> <p>Shanghai Edgelight Industry Co., Ltd. Add: 55 Beimin Rd. Songjiang District, Shanghai 上海边光实业有限公司 上海市松江区北闵路55号</p>
<p>AD-EL-2401200 (model/型号/品番/모델) Input (输入/入力/입력): 100-240VAC, 50/60Hz $\lambda > 0.9$ Output (输出/出力/출력): 24VDC, Max. (最大电流值/最大電流値/최대전류값) 5A 120W Tc: 85°C Ta: 45°C</p>	<p>LED POWER SUPPLY (LED控制装置 恒压型/ LED制御装置定圧タイプ/ LED 제어 장치 정압 타입)</p>	<p>EdgeLight Shift Lighting Technology™</p> <p>Shanghai Edgelight Industry Co., Ltd. Add: 55 Beimin Rd. Songjiang District, Shanghai 上海边光实业有限公司 上海市松江区北闵路55号</p>