

## Features

- Low  $R_{DS(on)}$
- Ultra-low  $Q_G$  For High Efficiency
- Logic Level
- Light Weight – 0.068 grams
- New Compact Hermetic Package
- Source Sense Pin
- Total Dose
  - Rated to 300 krad
- Single Event
  - SEE immunity for LET of 83.7 MeV/mg/cm<sup>2</sup> with  $V_{DS}$  up to 100% of rated Breakdown
- Low Dose Rate at 100 mRad/sec
  - Maintains Pre-Rad specification
- Neutron
  - Maintains Pre-Rad specification for up to  $1 \times 10^{15}$  Neutrons/cm<sup>2</sup>

## Applications

- Satellite and Avionics
- Deep Space Probes
- High Speed Rad Hard DC-DC Conversion
- Rad Hard Motor Controllers

## Thermal Characteristics

Symbol	Parameter-Conditions	Value	Units
$R_{\theta JA}$	Thermal Resistance Junction to Ambient (Note 3)	90	°C/W
$R_{\theta JC}$	Thermal Resistance Junction to Case	14	



## FBG20N04A

**Rad Hard eGaN<sup>®</sup> 200 V, 4 A,  
130 mΩ Surface Mount (FSMD-A)**

## Description

EPC Space FSMD-A series of eGaN<sup>®</sup> power switching HEMTs have been specifically designed for critical applications in the high reliability or commercial satellite space environments. These devices have exceptionally high electron mobility and a low temperature coefficient resulting in very low  $R_{DS(on)}$  values. The lateral structure of the die provides for very low gate charge ( $Q_G$ ) and extremely fast switching times. These features enable faster power supply switching frequencies resulting in higher power densities, higher efficiencies and more compact packaging.

## I/O Pin Assignment (Bottom View)

Pin	Symbol	Description
1	G	Gate
2	D	Drain
3	SS	Source Sense
4	S	Source



## Absolute Maximum Rating ( $T_C = 25^\circ\text{C}$ unless otherwise noted)

Symbol	Parameter-Conditions	Value	Units
$V_{DS}$	Drain to Source Voltage (Note 1)	200	V
$I_D$	Continuous Drain Current $I_D$ @ $V_{GS} = 5\text{ V}$ , $T_C = 25^\circ\text{C}$ , $R_{\theta JA} < 26^\circ\text{C/W}$	4	A
$I_{DM}$	Single-Pulse Drain Current $t_{pulse} \leq 270\ \mu\text{s}$	16	
$V_{GS}$	Gate to Source Voltage (Note 2)	+6 / -4	V
$T_J, T_{STG}$	Operating and Storage Junction Temperature Range	-55 to +150	°C
$T_{sol}$	Package Mounting Surface Temperature	260	
ESD	ESD Class	$\Delta A$	

**Electrical Characteristics** ( $T_C = 25^\circ\text{C}$  unless otherwise noted. Typical (TYP) values are for reference only.)

Parameter	Symbol	Test Conditions	MIN	TYP	MAX	Units	
Maximum Drain to Source Voltage	$V_{DSMAX}$	$V_G = 0\text{ V}$	-	-	200	V	
Drain to Source Leakage	$I_{DSS}$	$V_{DS} = 200\text{ V}$ $V_{GS} = 0\text{ V}$	$T_C = 25^\circ\text{C}$	-	26	50	$\mu\text{A}$
			$T_C = 125^\circ\text{C}$	-		100	
Gate to Source Forward Leakage	$I_{GSS}$	$V_{GS} = 5\text{ V}$	$T_C = 25^\circ\text{C}$	-	100	500	
Gate to Source Reverse Leakage	$I_{GSS}$	$V_{GS} = -4\text{ V}$	$T_C = 25^\circ\text{C}$		-5	-50	
Gate to Source Threshold Voltage	$V_{GS(th)}$	$V_{DS} = V_{GS}, I_D = 1\text{ mA}$	$T_C = 25^\circ\text{C}$	0.8	1.2	2.8	V
Gate to Source Threshold Voltage Temperature Coefficient	$\Delta V_{GS(th)}/\Delta T$	$V_{DS} = V_{GS}, I_D = 1\text{ mA}$	$-55^\circ\text{C} < T_A < 150^\circ\text{C}$	-	2.4	-	$\text{mV}/^\circ\text{C}$
Drain to Source Resistance (Note 4)	$R_{DS(on)}$	$I_D = 4\text{ A}, V_{GS} = 5\text{ V}$	$T_C = 25^\circ\text{C}$	-	68	130	$\text{m}\Omega$
Source to Drain Forward Voltage (Note 5)	$V_{SD}$	$I_S = 0.5\text{ A}, V_G = 0\text{ V}$	$T_C = 25^\circ\text{C}$		1.75		V

**Dynamic Characteristics** ( $T_C = 25^\circ\text{C}$  unless otherwise noted. Typical (TYP) values are for reference only.)

Parameter	Symbol	Test Conditions	MIN	TYP	MAX	Units
Input Capacitance	$C_{ISS}$	$f = 1\text{ MHz}, V_{DS} = 100\text{ V}, V_{GS} = 0\text{ V}$ (Note 6)		106	150	$\text{pF}$
Output Capacitance	$C_{OSS}$			72	90	
Reverse transfer Capacitance	$C_{RSS}$			2	6	
Gate Resistance	$R_G$	$f = 1\text{ MHz}, V_{DS} = V_{GS} = 0\text{ V}$		0.6		$\Omega$
Total Gate Charge (Note 7)	$Q_G$	$I_D = 4\text{ A}, V_{GS} = 5\text{ V}, V_{DS} = 100\text{ V}$		1.6	3	$\text{nC}$
Gate to Drain Charge (Note 7)	$Q_{GD}$			0.2	1	
Gate to Source Charge (Note 7)	$Q_{GS}$			0.5	1.8	
Output Charge (Note 8)	$Q_{OSS}$	$V_{GS} = 0\text{ V}, V_{DS} = 100\text{ V}$		13		
Source to Drain Recovery Charge	$Q_{RR}$	$I_D = 4\text{ A}, V_{DS} = 100\text{ V}$		<1		

### Radiation Characteristics

EPC Space eGaN<sup>®</sup> HEMTs are tested according to MIL-STD-750 Method 1019 for total ionizing dose validation. Every manufacturing lot is tested for total ionizing dose of Gamma radiation with an in-situ bias for (i)  $V_{GS} = 5\text{ V}$ , (ii)  $V_{DS} = V_{GS} = 0\text{ V}$  and (iii)  $V_{DS} = 80\% B_{VDSS}$ .

**Electrical Characteristics up to 300 krad** ( $T_C = 25^\circ\text{C}$  unless otherwise noted. Typical (TYP) values are for reference only.)

Parameter	Symbol	Test Conditions	MIN	TYP	MAX	Units
Maximum Drain to Source Voltage	$V_{DSMAX}$	$V_{GS} = 0\text{ V}$	-	-	200	V
Gate to Source Threshold Voltage	$V_{GS(th)}$	$V_{DS} = V_{GS}, I_D = 1\text{ mA}$	0.8	1.0	2.8	
Drain to Source Leakage	$I_{DSS}$	$V_{DS} = 200\text{ V}, V_{GS} = 0\text{ V}$	-	26	290	$\mu\text{A}$
Gate to Source Forward Leakage	$I_{GSS}$	$V_{GS} = 5\text{ V}$	-	100	500	
Gate to Source Reverse Leakage	$I_{GSS}$	$V_{GS} = -4\text{ V}$	-	-5	-50	
Drain to Source Resistance (Note 4)	$R_{DS(on)}$	$I_D = 4\text{ A}, V_{GS} = 5\text{ V}$	-	68	130	$\text{m}\Omega$

### Typical Single Event Effect Safe Operating Area

Note : All Single Event Effect testing is performed on the K-500 Cyclotron at Texas A&M University

Test	Environment				$V_{DS}$ Voltage (V)	
	Ion	LET $\text{MeV/mg/cm}^2$	Range $\mu\text{m}$	Energy MeV	$V_{GS} = 0\text{ V}$	$V_{GS} = -4\text{ V}$
See SOA	Xe	50	131	1653	200	200
	Au	83.7	130	2482	175	175

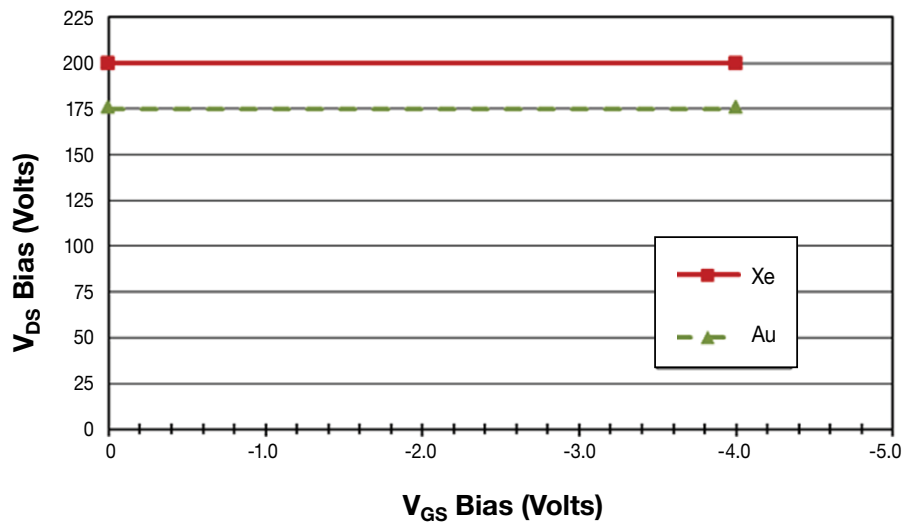

Figure 1. Typical Single Event Effect Safe Operating Area

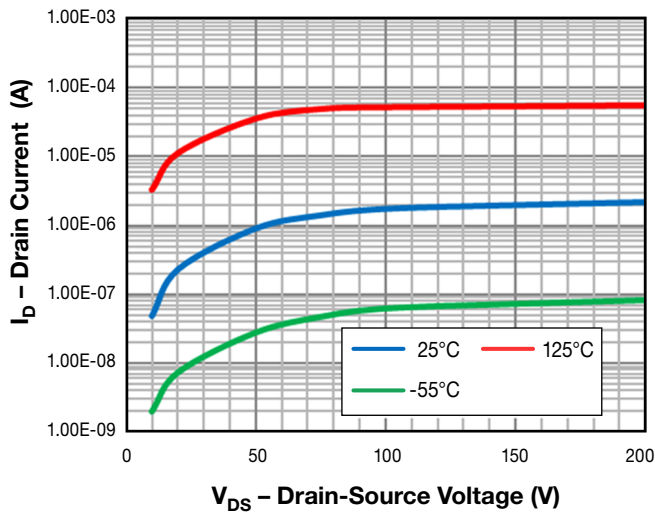

Figure 2. Typical Drain-Source Leakage Current vs. Ambient Temperature

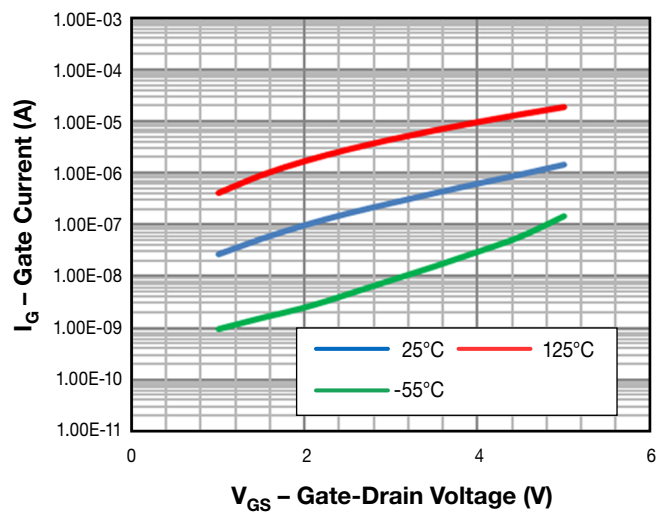

Figure 3. Gate-Source Leakage Current vs. Ambient Temperature

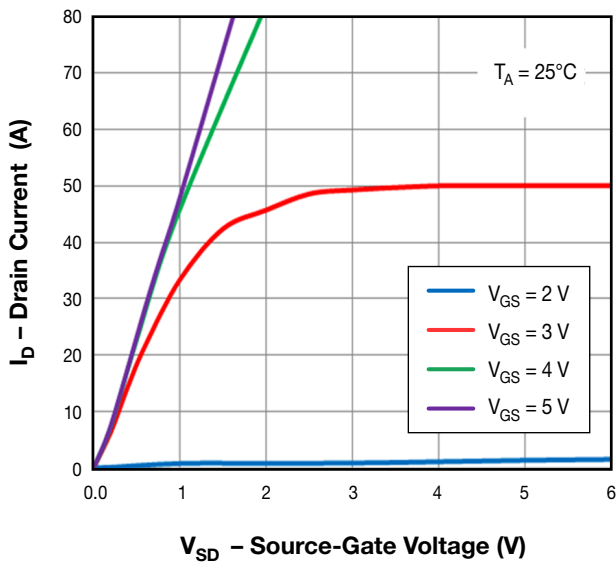

Figure 4. Typical Gate-Drain Transfer Characteristic

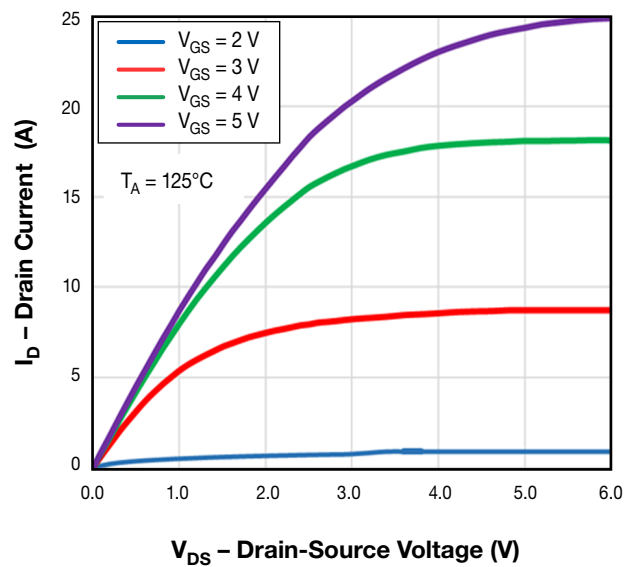

Figure 5. Typical Output Characteristics

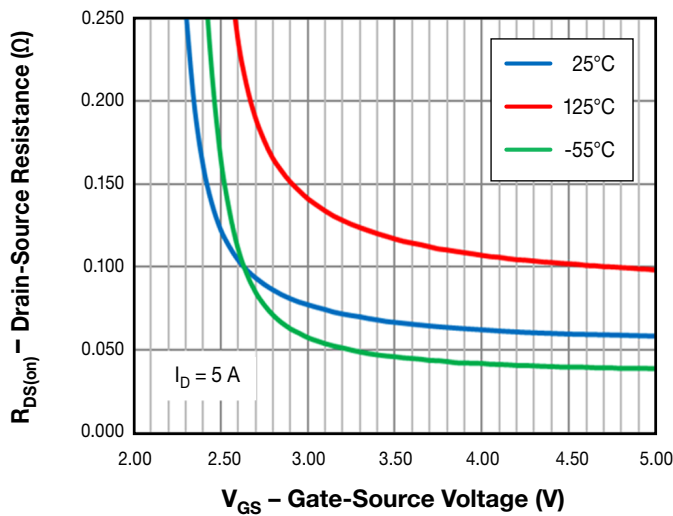

Figure 6. Typical Drain-Source ON Resistance vs. Gate-Source Voltage vs. Ambient Temperature

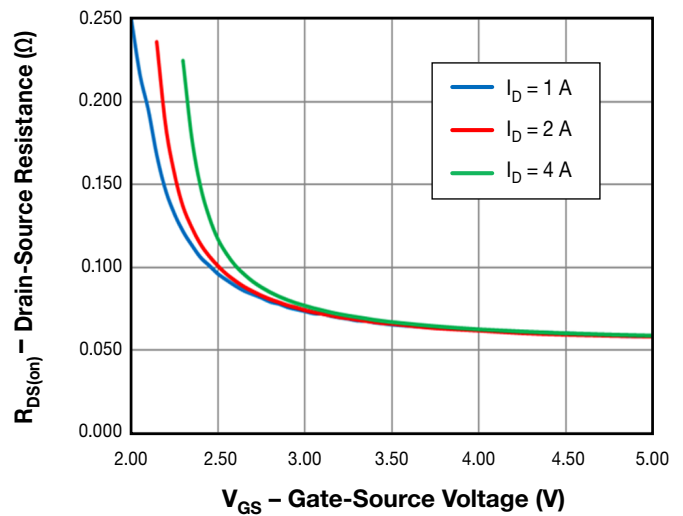

Figure 7. Typical Drain-Source ON Resistance vs. Gate-Source Voltage vs. Drain Current

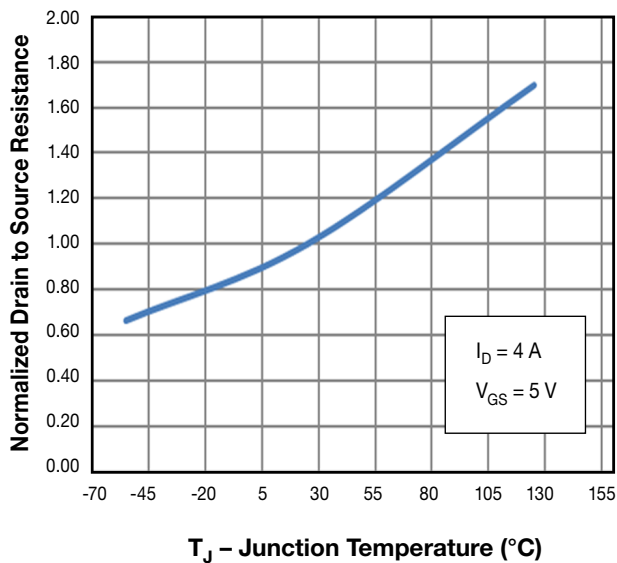

Figure 8. Typical Source-Drain Voltage vs. Temperature

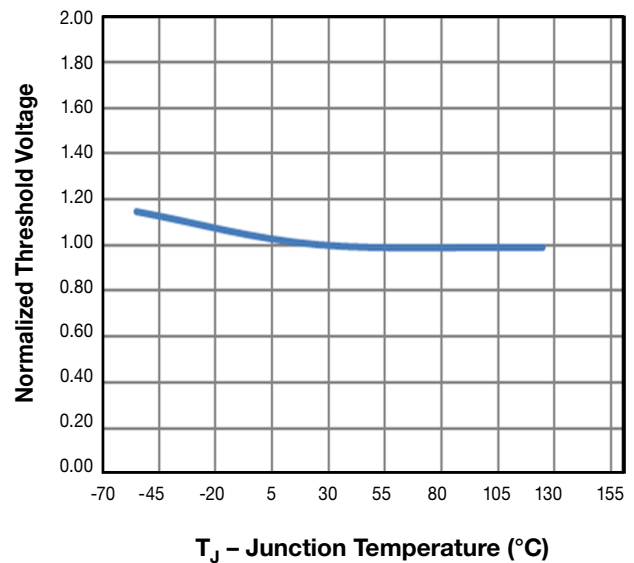

Figure 9. Normalized Drain-Source ON Resistance vs. Ambient Temperature

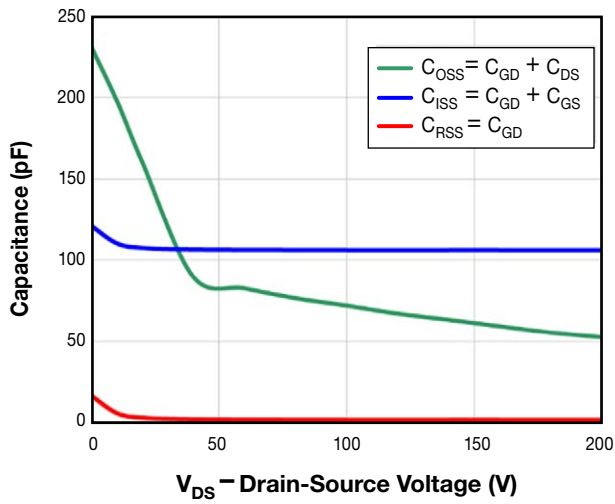

Figure 10. Typical Inter-Electrode Capacitance vs. Drain-Source Voltage

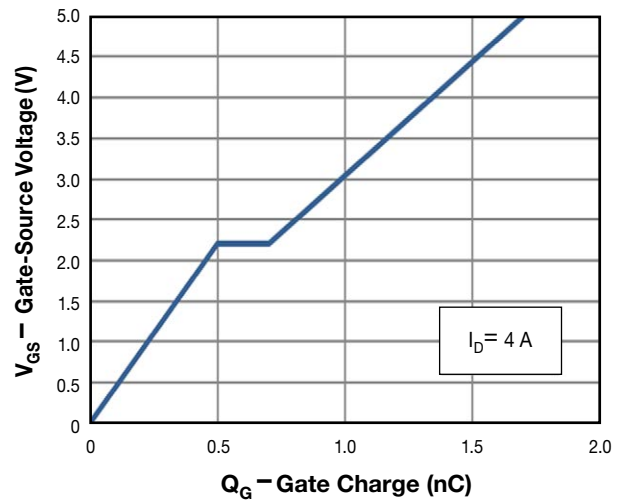

Figure 11. Typical Gate Charge vs. Gate to Source Voltage

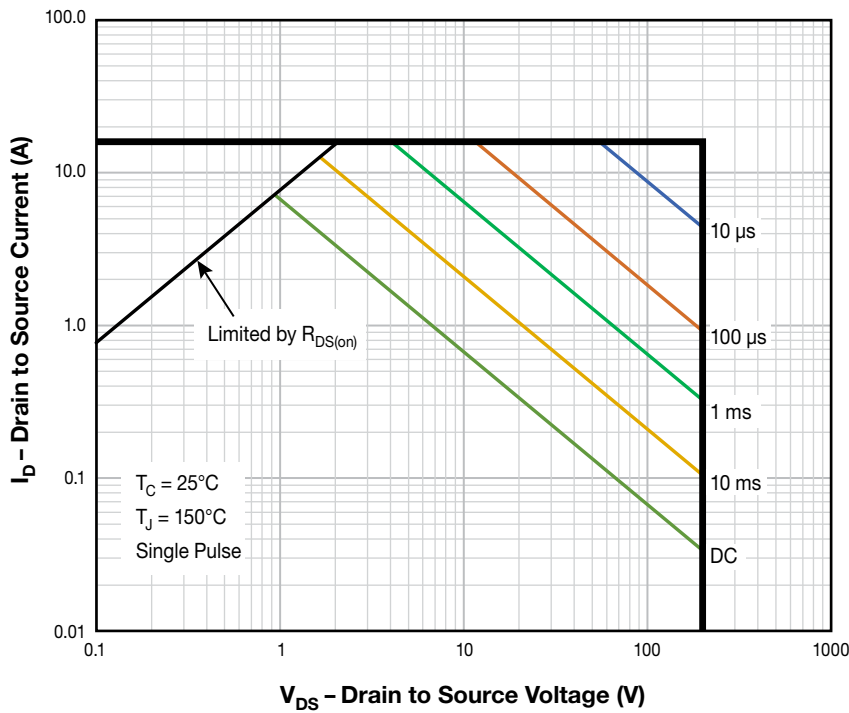

Figure 12. Safe Operating Area

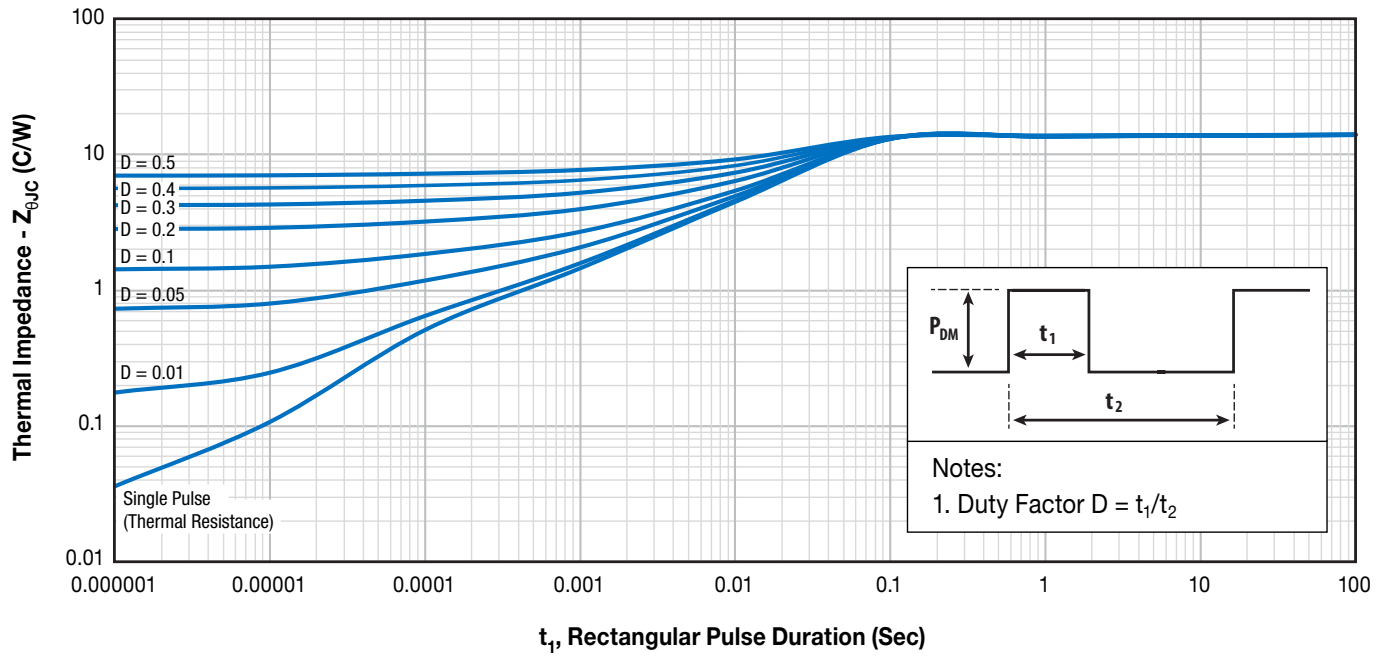

Figure 13. Transient Thermal Impedance, Junction to Case

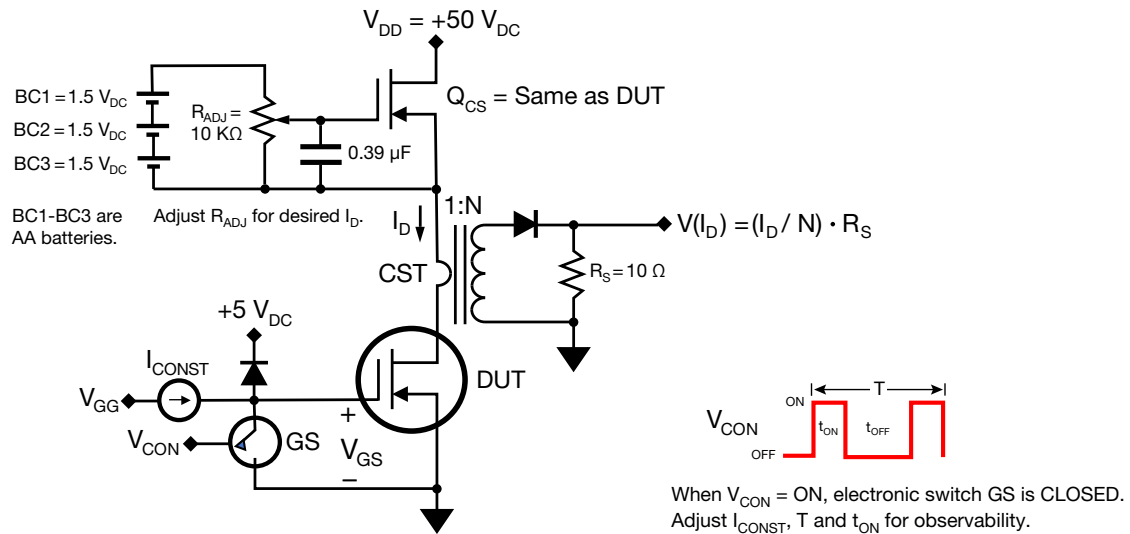

Figure 14. Charge Test Circuit

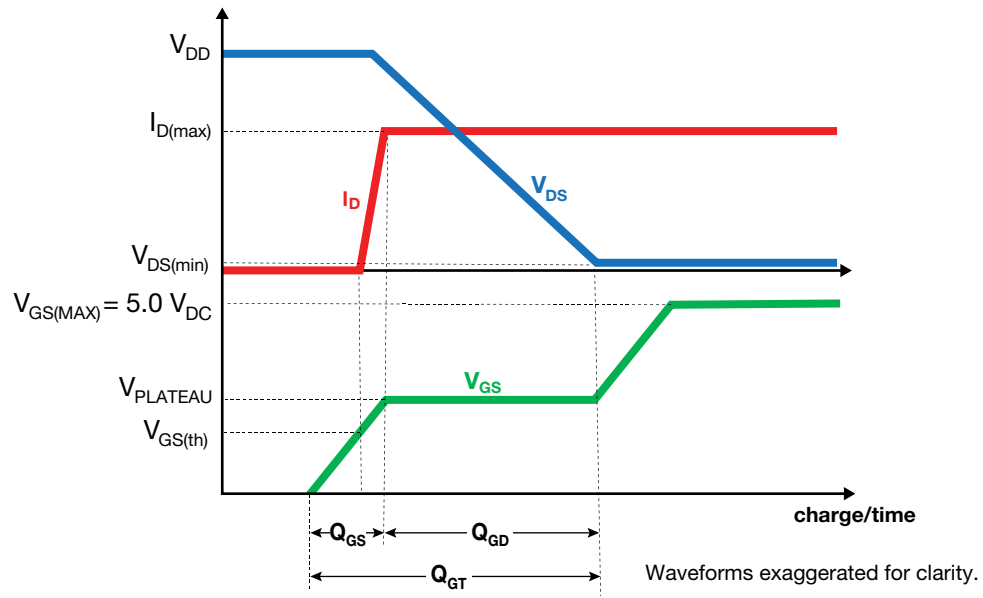
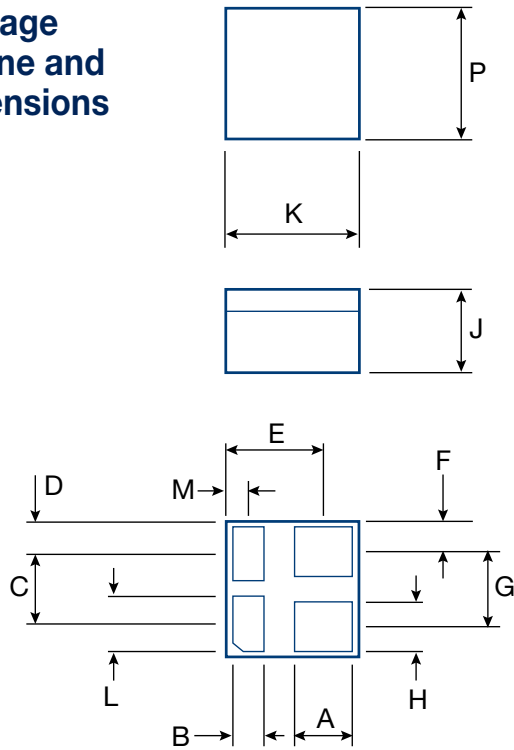

Figure 15. Typical Gate Charge Test Waveform



Package Outline and Dimensions



Symbol	Inches		Millimeters		Note
	MIN	MAX	MIN	MAX	
A	0.052	0.062	1.320	1.574	
B	0.027	0.037	0.685	0.939	
C	0.063	0.073	1.600	1.854	
D	0.026	0.036	0.660	0.914	
E	0.092	0.102	2.336	2.590	
F	0.024	0.034	0.609	0.863	
G	0.068	0.078	1.727	1.981	
H	0.042	0.052	1.066	1.320	
J	0.080	0.090	2.032	2.286	Ref. only
K	0.125	0.135	3.175	3.429	
L	0.048	0.058	1.219	1.473	
M	0.016	0.026	0.406	0.664	
P	0.125	0.135	3.175	3.429	

Standard Terminal Pad finish is a solder alloy of 63%Pb 37%Sn

Package Connections

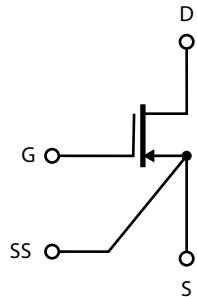

**NOTE:** SS pin is connected directly to source of internal die.

FSMD-A Footprint for Printed Circuit Board Design

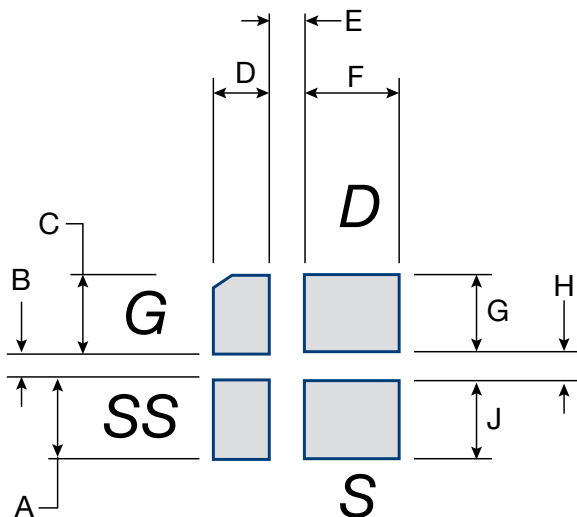

Symbol	Inches		Millimeters		Note
	MIN	MAX	MIN	MAX	
A	0.051	0.061	1.295	1.549	
B	0.010	0.020	0.254	0.508	
C	0.051	0.061	1.295	1.549	
D	0.033	0.043	0.838	1.092	
E	0.020	0.030	0.508	0.762	
F	0.058	0.068	1.473	1.727	
G	0.048	0.058	1.219	1.473	
H	0.015	0.025	0.381	0.635	
J	0.048	0.058	1.219	1.473	

## Notes

- Note 1. NEVER exceed the absolute maximum  $V_{DS}$  of the device otherwise permanent damage/destruction may result.
- Note 2. NEVER exceed the absolute maximum  $V_{GS}$  of the device otherwise permanent damage/destruction may result. We recommend use at no greater than +5 V as the HEMT is fully conducting at this point.
- Note 3.  $R_{\theta JA}$  measured with FSMD-A package mounted to double-sided PCB, 0.063" thickness with 1.0 square inches of copper area on the top (mounting side) and a flood etch (3 square inches) on the bottom side.
- Note 4. Measured using four wire (Kelvin) sensing and pulse measurement techniques. Measurement pulse width is 80  $\mu$ s and duty cycle is 1%, maximum.
- Note 5. Operation of the device in the third quadrant region is not recommended.
- Note 6.  $C_{ISS} = C_{GS} + C_{GD}$  with  $C_{DS}$  shorted.  $C_{OSS} = C_{DS} + C_{GD}$ .  $C_{RSS} = C_{GD}$ .
- Note 7. The gate charge parameters are measured using the circuit shown in Figure 11. Qs and associated components BT1, P1 and C1 form a high speed current source that serves as the test load for the DUT. A constant gate current ( $I_{const}$ ) of 1.5-3 mA is provided to the Gate of the DUT during the time that the ground switch ( $G_S$ ) is OFF ( $t_{off}$ ). The DUT is switched ON and OFF using ground-sensed switch GS. The gate current is adjusted to yield the desired charge per unit time ( $I_{const} \cdot \text{time per division}$ ) on the measuring oscilloscope. The GS pulse drive ON time ( $t_{on}$ ) is adjusted for the desired observability of the gate-source voltage ( $V_{GS}$ ) waveform. The maximum duty cycle of the ground switch ( $t_{off}/t_{on}$ ) should be set to 1% maximum. Please note that all gate-related signals are referenced to the "Source Sense" pin on the package. At all times during the measurement, the maximum gate-source voltage is clamped to 5  $V_{DC}$ .
- Note 8. Guaranteed by design/device construction. Not tested.

### EPC Space Part Number Information

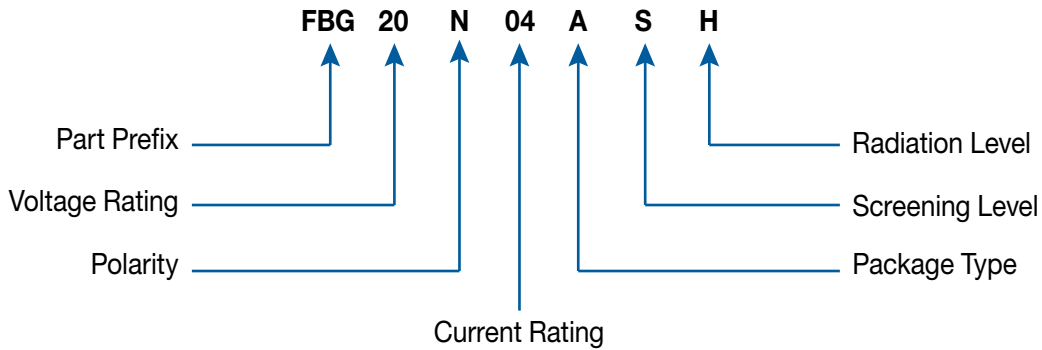

### Ordering Information Availability

Screening Options	Rad Assurance Options
1 character	1 character
C = Developmental Unit S = Space Level <sup>1</sup>	H = 1000 krad, LET = 84

Part Number	Screening Level	Shipping
FBG20N04A*C	Developmental Units	Waffle trays
FBG20N04A*S	Space Level	

<sup>1</sup> Screening and qualification consistent to an equivalent MIL-PRF-19500 specification.

FBG20N04AC devices are intended for engineering development purposes only and are NOT intended to be used as flight units.

EPC Space Rad Hard HEMT are not sensitive to Total Ionizing Dose as such the H level covers the R,F,G radiation levels.

EPC Space Product Marking Information

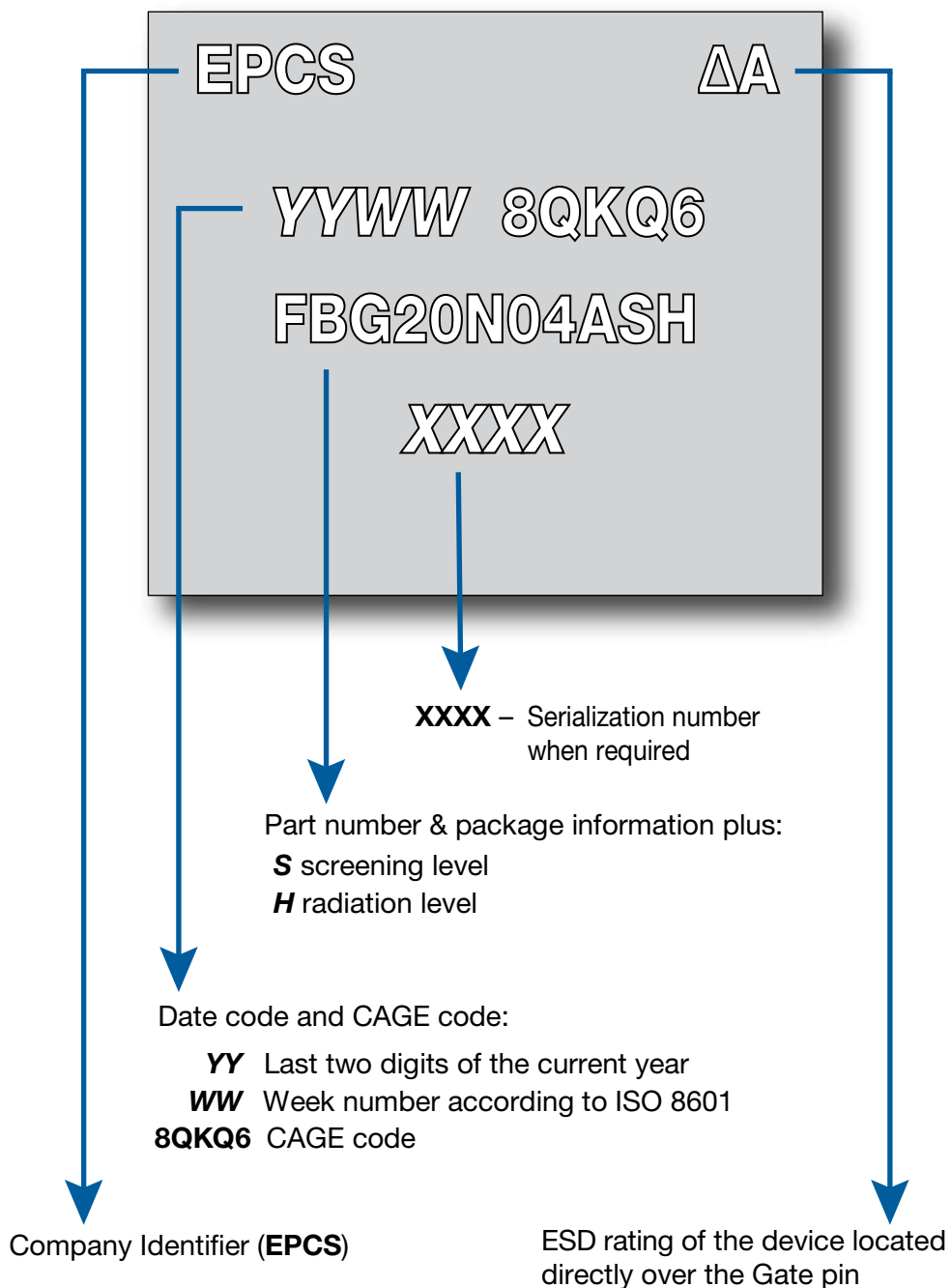

## Screening Flow Equivalent to a MIL-PRF-19500 General Specification

EPC SPACE Qual Flow Equivalent to a MIL-PRF-19500 Specification					
Operation	Test	Test Methods Per Mil STD 750	Sample Size	Space Level	COT
<b>Pre-Assembly</b>	Probe Testing	EPC SPACE Internal	100%	✓	✓
	Visual inspection	EPC SPACE Internal	100%	✓	✓
<b>Post-Assembly</b>	Die Shear	2,017	5	✓	✓
	X-Ray	2076	5	✓	✓
<b>Screening</b>	Serrialization		100%	✓	
	Electricals	3411,3413,3421,3404	100%	✓	✓
	Temp Cycling	1051	100%	✓	
	Constant Acceleration	2006	100%	✓	
	PIND	2052	100%	✓	
	Initial Electricals (Read and Record)	3411,3413,3421,3404	100%	✓	
	HTGB	1042 Condition B	100%	✓	
	Interim Electricals (Read and Record)	3411,3413,3421,3404	100%	✓	
	HTRB	1042 Condition A 240 Hours	100%	✓	
	Final Electricals (Read and Record)	3411,3413,3421,3404	100%	✓	
	Final Electricals (High and Low Temperatures)	3411,3413,3421,3404	100%	✓	
	Deltas	Per Procurement Specification	100%	✓	
	Percent Defective Allowable	Per Procurement Specification	100%	✓	
	Dynamic RDSON	EPC SPACE Internal	100%	✓	
	OutLiers Removal	EPC SPACE Internal	100%	✓	
	X-RAY	2076	100%	✓	
	Tinning		100%	✓	
	Hermetic Seal, Fine & Gross Leak	1071	100%	✓	
	Final Electricals	3411,3413,3421,3404	100%	✓	
	<b>Group A Inspection (Conformance)</b>	A-2 DC Static Tests at 25°C	3411,3413,3421,3404	116	✓
A-3 High & Low Temp DC Static Tests		3411,3413,3421,3404	116	✓	
A-7 Gate Charges		3471 Condition B	45	✓	
A-7 Capacitance		3473	45	✓	
<b>Group B Inspection (Conformance)</b>	B-1, B-2, B-3, B-4, B-5	Sample base equivalent to a MIL-PRF-19500 flow or as required by procurement speciffication			
<b>Group C Inspection (Conformance)</b>	C-1, C-2, C-3, C-4, C-6, C-7	Sample base performed yearly per package style equivalent to a MIL-PRF-19500 flow or as required by procurement specification			
<b>Group D Inspection (Conformance)</b>	TID	1019	15	✓	
	SEE	1080	5	✓	
<b>Group E Inspection (Qualification Inspection)</b>	E-1, E-2, E-5, E-6 E-7	Performed during product introduction or a major process change equivalent to a MIL-PRF-19500 flow or as required by procurement specification			
	E8 Switching				

## Disclaimers

ALL PRODUCT, PRODUCT SPECIFICATIONS AND DATA ARE SUBJECT TO CHANGE WITHOUT NOTICE TO IMPROVE RELIABILITY, FUNCTION OR DESIGN OR OTHERWISE. EPC Space Corporation, its affiliates, agents, employees, and all persons acting on its or their behalf (collectively, “EPC Space”), disclaim any and all liability for any errors, inaccuracies or incompleteness contained in any datasheet or in any other disclosure relating to any product. EPC Space makes no warranty, representation or guarantee regarding the suitability of the products for any particular purpose. To the maximum extent permitted by applicable law, EPC Space disclaims (i) any and all liability arising out of the application or use of any product, (ii) any and all liability, including without limitation special, consequential or incidental damages, and (iii) any and all implied warranties, including warranties of fitness for particular purpose, non-infringement and merchantability. Statements regarding the suitability of products for certain types of applications are based on EPC Space market knowledge of typical requirements that are often placed on similar technologies in generic applications. Product specifications do not expand or otherwise modify EPC Space terms and conditions of purchase, including but not limited to the warranty expressed therein. Except as expressly indicated in writing, EPC Space products are not designed for use in medical, life-saving, or life-sustaining applications or for any other application in which the failure of the EPC Space product could result in personal injury or death. Customers using EPC Space products not expressly indicated for use in such applications do so at their own risk. Please contact authorized EPC Space personnel to obtain written terms and conditions regarding products designed for such applications. No license, express or implied, by estoppel or otherwise, to any intellectual property rights is granted by this document or by any conduct of EPC Space. Product names and markings noted herein may be trademarks of their respective owners.

### Export Administration Regulations (EAR)

The products described in this datasheet could be subjected to the Export Administration Regulations (EAR). They may require an approved export license prior to export from the United States. An export includes release of product or disclosure of technology to a foreign national inside or outside the United States.

### International Traffic in Arms Regulations (ITAR)

The products described in this datasheet could be subjected to the International in Arms Regulations (ITAR). They require an approved export license prior to export from the United States. An export includes release of product or disclosure of technology to a foreign national inside or outside the United States.

### Patents

EPC Corporation and EPC Space hold numerous worldwide patents. Any that apply to the product(s) listed in this document are identified by markings on the product(s) or on internal components of the product(s) in accordance with local patent laws.

*eGaN® is a registered trademark of Efficient Power Conversion Corporation, Inc. Data and specification subject to change without notice.*

## Revisions

Datasheet Revision	Product Status
REV P#	Proposal/development
REV Q#	Characterization and Qualification
M-700-005-E	Production Released

Information subject to change without notice.

Revised September 2022