

ADVANCE IR >>

TSCAN-750

Temperature Scanning Entry System User Manual

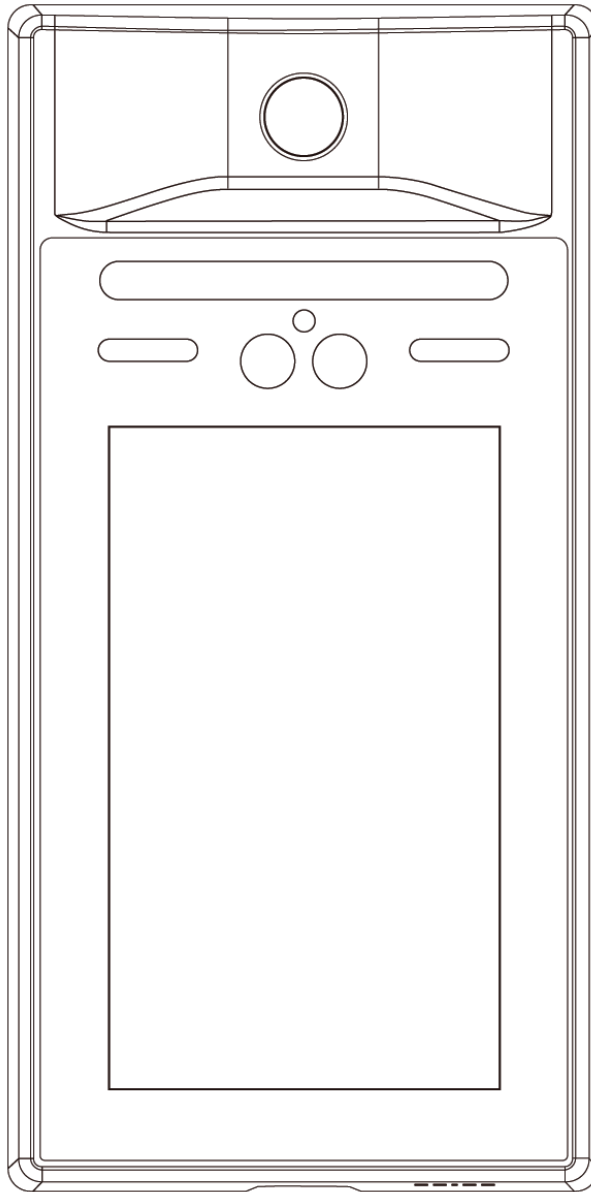

Please read this manual before powering the unit on.
Important safety information inside.

Table of Contents

Introduction	3
Box Contents	4
Product Appearance & Interface Instruction	4
Wiring Instruction	5
Access Control and Attendance:	
Company Mode	6
Operation Process	6
Add Device and Import Information	6
Network Settings	7
Operate Code Settings	8
Data Sync	8
Menu Items	9
Homepage	9
Sync Data	9
Register Face	9
Access	10
Settings	10
Network Settings	11
Operate Code Setting	11
Parameter Settings	11
White Light	11
Voice Broadcast	11
Similarity Threshold	11
Mask Detection	12
Access Control Settings	12
Online Update	12
About	12
Help	12
Language Settings	12
Restore Factory Settings	12
Temperature Scanning Notes	12
Education Mode	13
Operation Process	13
Add Device and Import Information	13
Network Settings	14
Operate Code Settings	14
Data Sync	14
Menu Items	15
Homepage	16
Sync Data	16
Register Face	16
Access	16
Settings	16
Network Settings	17
Operate Code Setting	17
Parameter Settings	17
Access Control Settings	18
Online Update	18
About	18
Help	18
Language Settings	18
Restore Factory Settings	18
Quick Screen Mode	19
Operation Process	19
Add Device	19
Settings	20
Network Settings	20
Measuring Modes	20
Parameter Settings	20
Access Control Settings	20
Online Update	20
About	21
Help	21
Language Settings	21
Restore Factory Settings	21
Technical Specifications	22
Installation Instructions	23-24

Introduction

TSCAN-750 Temperature Scanning Entry System supports three usage modes and is equipped with different platform software for more powerful functions.

1. Company Mode - Combined facial recognition and temperature measurement for employee access control and attendance management. Equipped with web interface to view historical statistics.
2. Education Mode - Combined facial recognition and temperature measurement for student/staff access control and attendance management. Equipped with web interface to view historical statistics.
3. Quick Screening Mode – Allows entry based on temperature reading without facial recognition. Temperature and entry statistics available via mobile app.

Notice:

- To ensure the normal operation of the temperature measurement module, the device needs to be warmed up for more than 2 hours after it is powered on.
- During installation and use, all electrical safety regulations of the country and region of use must be strictly observed.
- When wiring, installing, and disassembling, please be sure to disconnect the power supply. Do not perform any of these operations with electricity.
- If the device emits smoke, produces unusual odors, or makes noises, immediately turn off the power and unplug it; contact the dealer or service center.
- If the equipment is not working properly, please contact customer service. Do not disassemble or modify the equipment in any way. (The company does not assume any responsibility for problems caused by unauthorized modification or maintenance.)
- Do not drop objects on the device or vibrate the device vigorously. Keep the device away from magnetic interference.
- Avoid installing the device where the surface vibrates or is vulnerable to shock.
- Avoid installing the device at the air outlet of the air conditioner or in a place with large airflow fluctuations.
- Avoid placing the device in direct sunlight, poorly ventilated locations, or near heat sources.
- Ensure that the equipment is installed vertically.
- Do not use the device in high temperature, low temperature or high humidity environments.
- Biometric products cannot be 100% suitable for any anti-counterfeiting environment. High security level places, please use combination authentication.
- Do not touch the temperature probe with your fingers or blow air on the probe.
- Please make sure no hair, sweat, or hat covers your forehead while measuring temperature.
- If the forehead is cold, allow enough time for the forehead to reach room temperature before taking temperature measurement. Examples: After washing the face, applying ice, or entering the room from outside in winter conditions.
- Do not aim the lens of the device at strong light objects, such as the sun, incandescent lamps, etc.; otherwise, it will cause lens damage.

Box Contents

- TSCAN-750 Unit
- 1 Power Adapter
- 4 International Adapters: 1x Type A, 1x Type C, 1x Type G, 1x Type O No Ground
- 4 Cables: 1 x 2 pin, 1 x 6 pin, 1 x 7 pin, and 1 x 11 pin
- 1 Port Cover
- 1 Wall Mount Kit:
 - 1 Wall Mount Plate
 - 4 Wall Plugs
 - 4 KA 4x25 Screws
 - 4 KM 4x10 Screws
 - 4 Hex Screws
 - 4 Hex Nuts
 - 8 Flat Washers
 - 1 1/4-20 3/8" Phillips Screw

Product Appearance

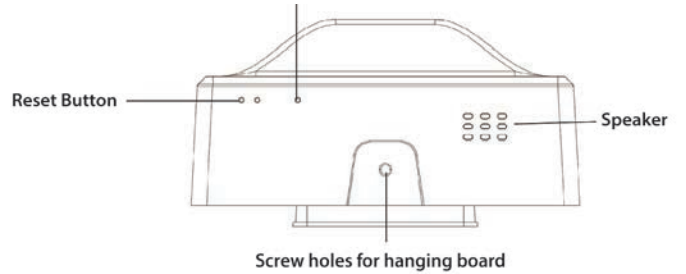
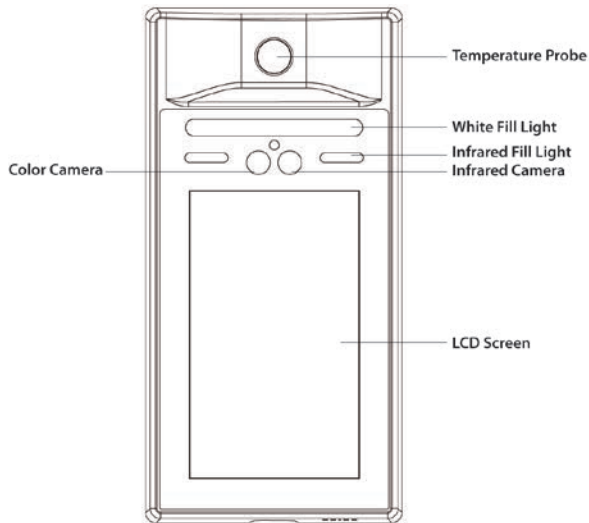

Interface Instruction

1 6-Pin Door Button, Door Sensor, and Alarm Interface

1	2	3	4	5	6
5V	GND	NC	Open Button	Door Sensor	Alarm

2 11-Pin Reserved IO

1	2	3	4	5	6	7	8	9	10	11
	PWRON	IO7	GND	3.3V	IO6	IO5	IO4	IO3	IO2	IO1

3 7-Pin 12V Power Supply, Relay Interface

1	2	3	4	5	6	7
COM	NO	NC	GND	GND	12V	12V

4 Ethernet Port

5 2-Pin 485 Interface

1	2
485A	485B

6 Tamper Key

7 Micro USB Port

8 USB-A Port

9 12V Power Adapter Socket

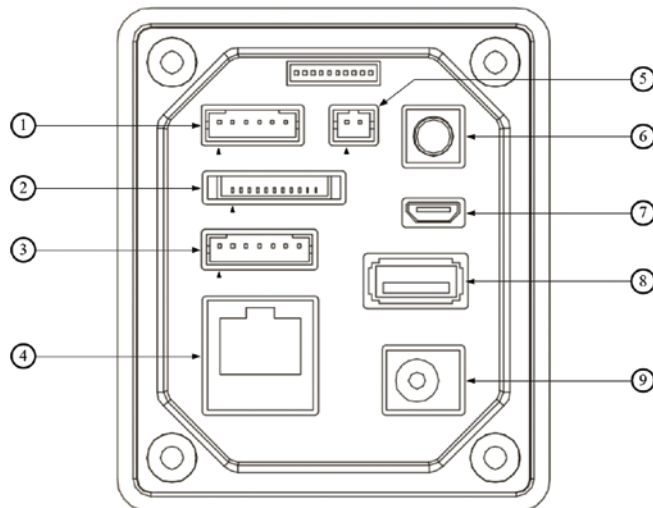

Wiring Instruction

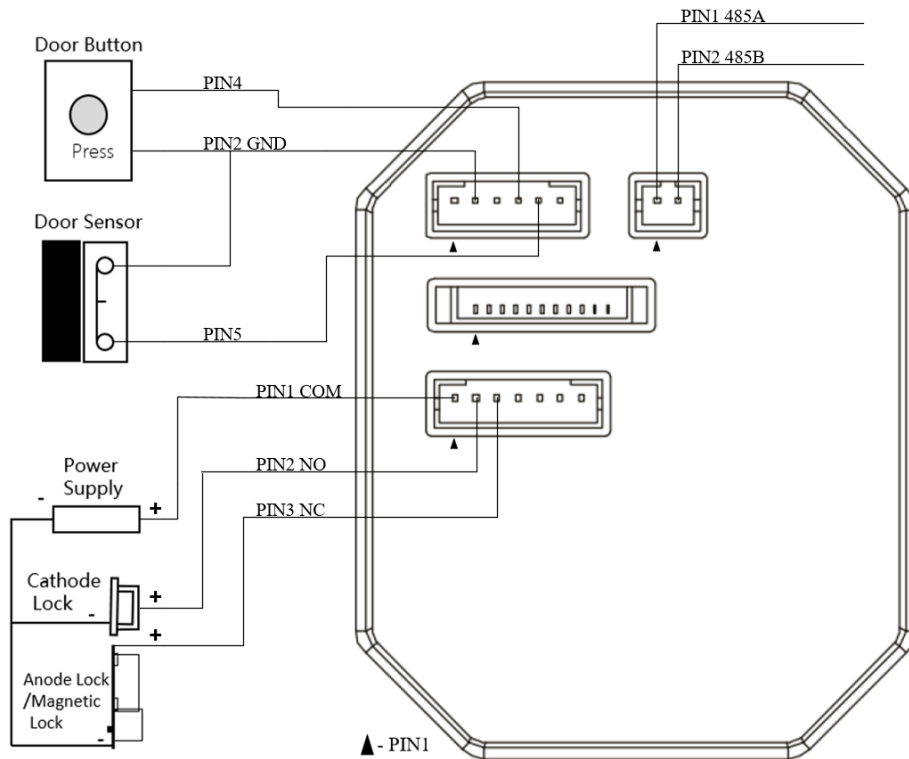

Bypass Wiring for Access Control Installations

For Access Control installations using the Normally Closed relay to make/break the supply voltage to the magnetic door lock, a bypass switch/relay is recommended to maintain secure access to the building. In the event Connector 3 7-Pin 12V Power Supply, Relay Interface is disconnected from the TSCAN-750, the bypass switch/relay provides a solution to maintain secure building access control.

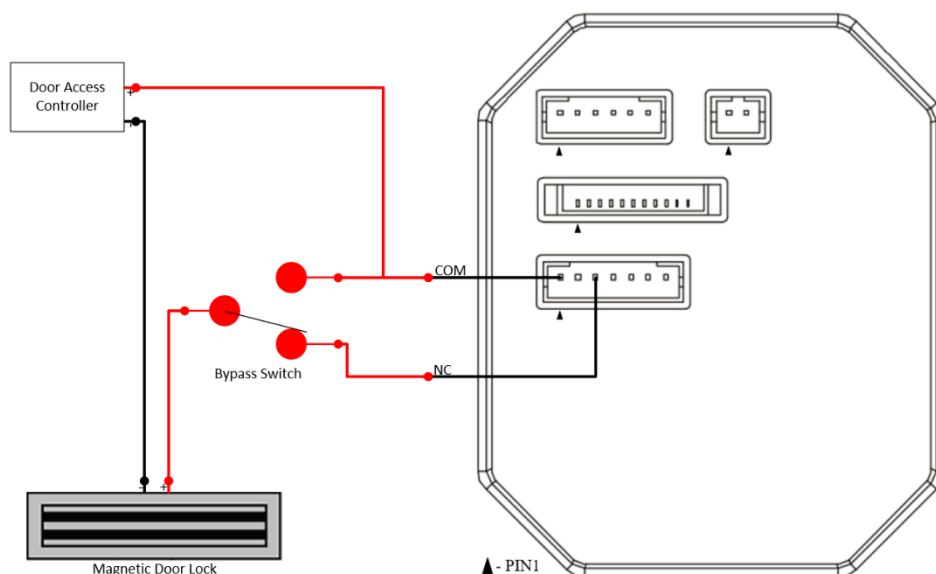

Access Control and Attendance - Company Mode

Operation Process

To access Company Mode, click the following button.



Add Device and Import Information

Login to the Attendance & Access Control Management Platform Software.

Enter the device management interface to add the device. The device ID number must be consistent with the main interface on the device.

Import employee information, employee face photos, and configure this device as an attendance device for employees.

For details of operation, please refer to the instructions of the management platform software.

The Attendance & Access Control Management Platform Software for Company should be deployed on a local workstation within your network environment.

Once installed, the TSCAN-750 must be updated with the web address of the Management Platform Software.
<http://<servername>:30091>

Users can also deploy according to their needs.

Company Mode (cont.)

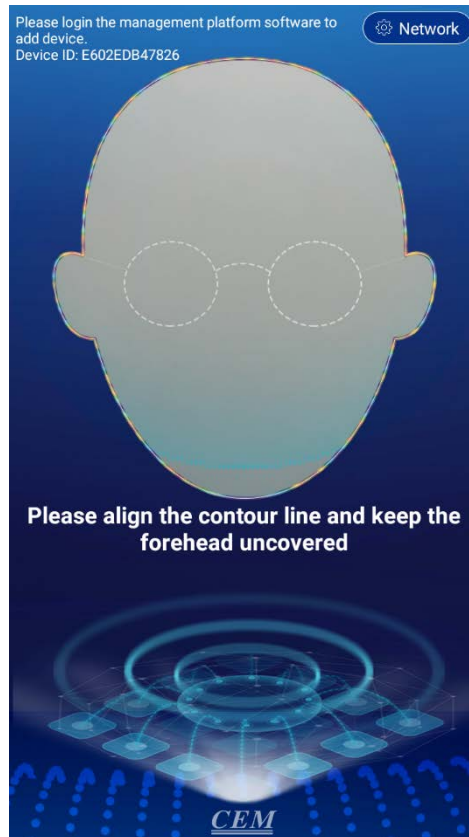

Network Settings



Select the button in the upper right corner to set the service domain name settings for “Domain Name Settings” and “Network Settings.”

The address defaults to the company’s service platform access address. This address should be changed to the local server or workstation on which you installed the Attendance & Access Control Management Platform Software.

Configure the device to connect to the network. You can choose WIFI or Ethernet. If the device is successfully added through the management platform software and the device is successfully connected to the network, a menu icon  will appear in the upper left corner of the main interface of the device.



Company Mode (cont.)

Operate Code Settings

Click  and enter an operate code of your choosing. The initial code that you enter into this field will serve as the Operate Code used to access the Settings Menu going forward. For example, if you enter 1234 as your initial Operate Code, then you will need to use 1234 as your code each time you enter the Settings Menu.

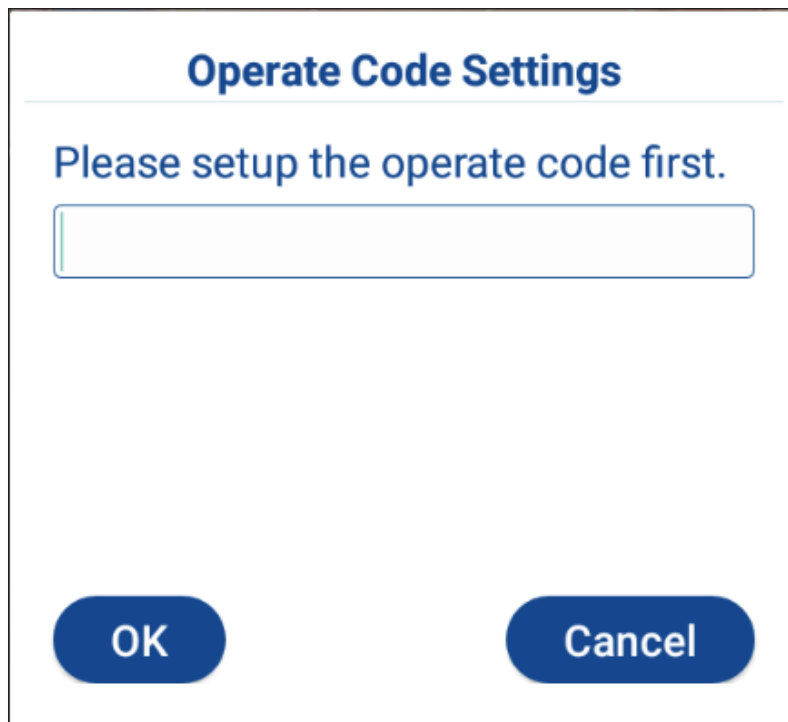

The image shows a dialog box titled "Operate Code Settings". Inside the dialog, there is a message that says "Please setup the operate code first." Below the message is a rectangular input field for entering the code. At the bottom of the dialog, there are two buttons: "OK" on the left and "Cancel" on the right.

Data Sync

After the operation code is set, data synchronization will start automatically.

The number on the left shows the number of faces that have been synchronized, and the number on the right shows the number of faces to be synchronized.

After the synchronization is complete, you can start face recognition temperature measurement access control attendance.

Note: If there are many faces in one synchronization, the synchronization time will take longer, please be patient.

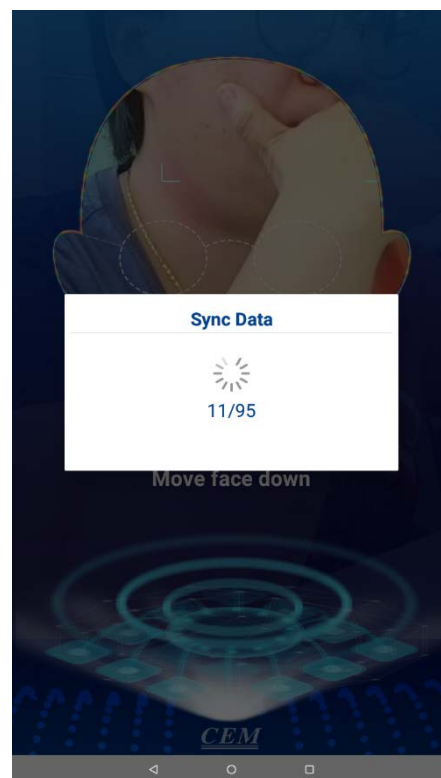

Company Mode (cont.)

Menu Items

The Menu icon  is hidden on the homepage. To display the icon, you must double-tap the screen.

After clicking the menu icon, the interface for entering the operate code is displayed. Enter the operate code, and once verified, the menu item page is displayed.

Homepage

Click to return to the scanning homepage.

Sync Last Data

The device only syncs the last modified or added user data and face photos.

Sync All Data

The device will clear the local cached data, and re-sync all user data and face photos. Depending on the number of users registered in the Access Control & Attendance Management Platform Software, this can take an extended period of time.

Register Face

Through the Access Control & Attendance Management Platform Software, after entering the employee information, you can choose to register the face on the device.

If the face photos entered into Access Control & Attendance Management Platform Software are unqualified and the employee cannot perform face recognition, they can also choose to register faces on the device.

You can enter the Name / ID and perform a search. After finding the corresponding employee information, choose to register the face or re-register to enter the face.

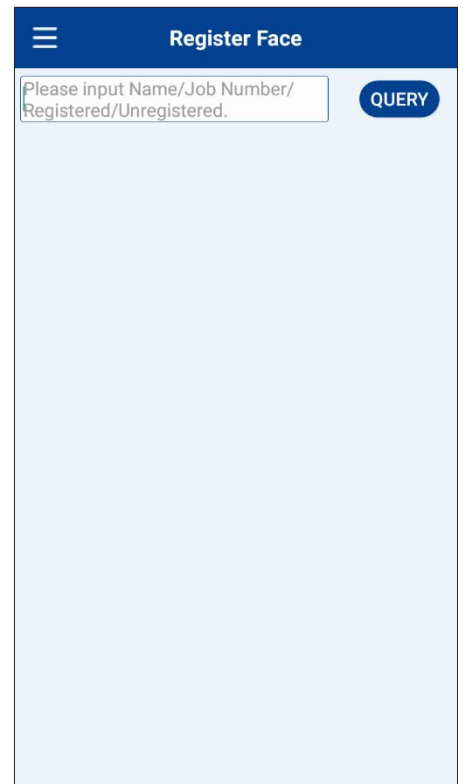
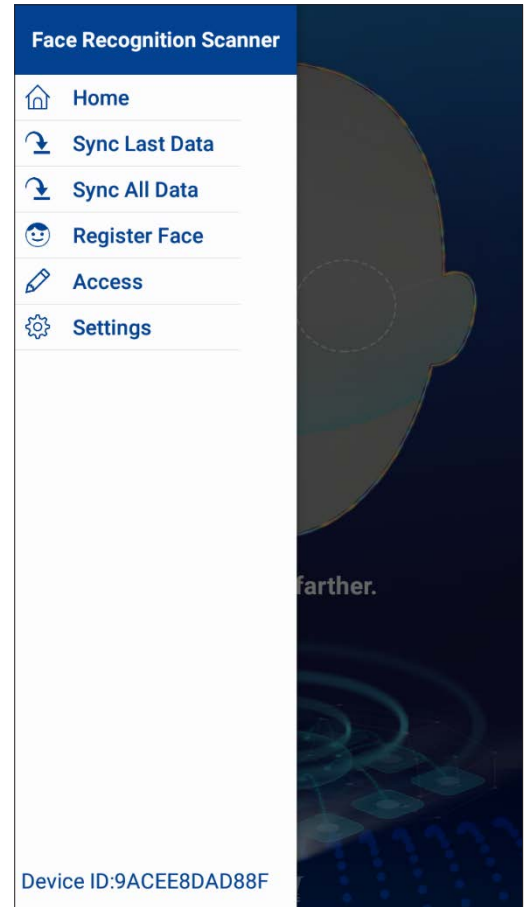

Company Mode (cont.)

Access

If the face cannot be recognized, you can choose Access to verify.

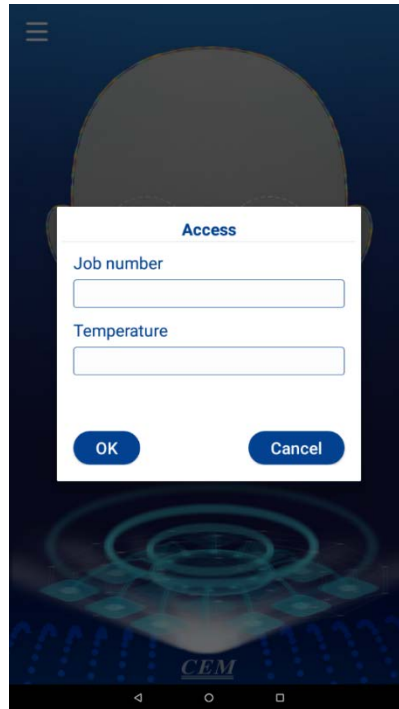

Settings

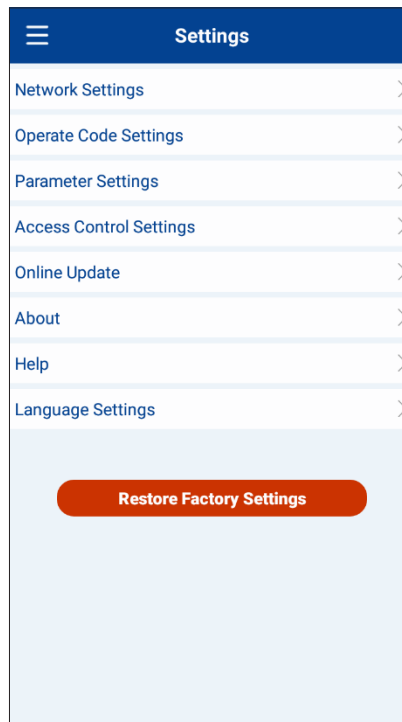

Company Mode (cont.)

Network Settings

Set up device networking.

Operate Code Setting

Modifying the operation code requires that the device is in the online state.

It can be viewed in the software/device management of the access control and attendance management platform to prevent forgetting the operation code.

Parameter Settings

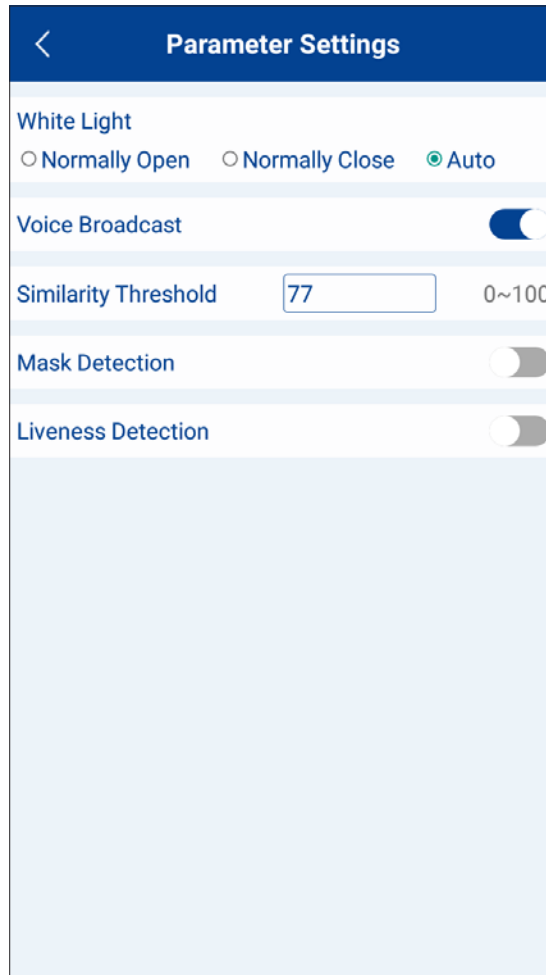

White Light

The white light can be set to normally open / normally closed / auto. When set to automatic, it will automatically adjust on/off according to whether there is face detection or not.

Voice Broadcast

Control the opening and closing of voice announcements.

Similarity Threshold

The threshold adjustment will affect the pass rate and false detection rate of face recognition.

If the face similarity threshold is set higher, the comparison will be stricter and the pass rate will be relatively reduced.

If the mask recognition threshold is set higher, it may lead to an unrecognizable scan. If the threshold is set lower, the false detection rate will increase. For example, if the original person is not entered and the threshold is set lower, it may be identified as an employee in the photo library that is similar to the person.

Company Mode (cont.)

Mask Detection

When mask detection is enabled, only those wearing masks can pass. If someone is detected not wearing a mask, an alarm will be issued and they will not be able to pass.

When the liveness detection is enabled, the live detection infrared fill light will be performed after recognition. It can be set to normally open / normally closed / auto. When set to automatic, it will automatically adjust on/off according to whether there is face detection. Only pass the liveness detection to enter.

Access Control Settings

The action time of the door lock can be set to specify long it will automatically close after the door is opened.

Door sensor type can be selected according to the actual installed door sensor type, either normally open / normally closed.

Door magnetic alarm - If the door is not opened or closed normally, the alarm will be triggered.

Online Update

Online upgrade requires that the device be connected to an external network.

Click Online Upgrade to automatically detect whether the software has a version update. If there is a version update, it will automatically update the latest version of the software.

About

Check device software version information.

Help

View instructions.

Language Settings

Change the system language.

Restore Factory Settings

Proceed with caution - If you choose to restore the factory settings, the device will clear all data and restore to the state of initial use.

Temperature Scanning Notes

Pay attention to the following points during time and attendance of face recognition temperature measurement:

- Please align the full face with the outline of the face on the homepage.
- Adjust facial position according to the prompt below the outline on the screen.
- The forehead must not be covered by hair, clothing, jewelry, etc., which could prevent a clear temperature reading.

Access Control and Attendance - Education Mode

Operation Process

To access Education Mode, click the following button.



Add Device and Import Information

Login to the Attendance & Access Control Management Platform Software.

Enter the device management interface to add the device. The device ID number must be consistent with the main interface on the device.

Create the campus, grade, and class. Import student and teacher information, student and teacher face photos, and configure this device as an attendance device for class.

For details of operation, please refer to the instructions of the management platform software.

The Attendance & Access Control Management Platform Software for Company should be deployed on a local server or workstation within your network environment.

Once installed, the TSCAN-750 must be updated with the web address of the Management Platform Software.
<http://<servername>:30091>

Users can also deploy according to their needs.

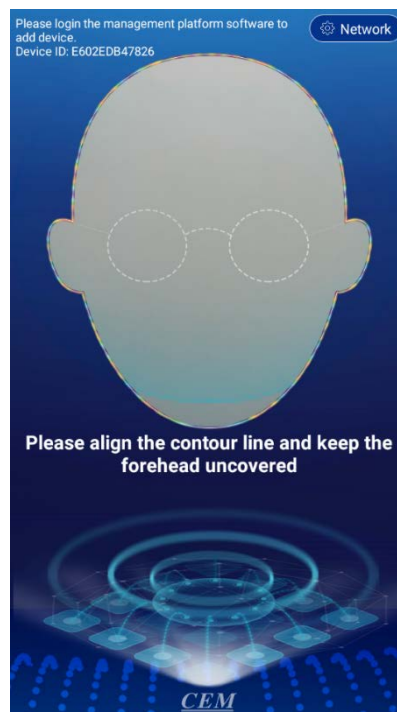

Education Mode (cont.)

Network Settings



Select the button in the upper right corner to set the service domain name settings for “Domain Name Settings” and “Network Settings.”

The address defaults to the service platform access address. This address should be changed to the local server or workstation on which you installed the Attendance & Access Control Management Platform Software.

Configure the device to connect to the network. You can choose WIFI or Ethernet. If the device is successfully added through the management platform software and the device is successfully connected to the network, a menu icon will appear in the upper left corner of the main interface.



Operate Code Settings

Click  and enter the operate code. (The first time you enter this screen, and enter a code, that becomes the code moving forward, for all future use.)

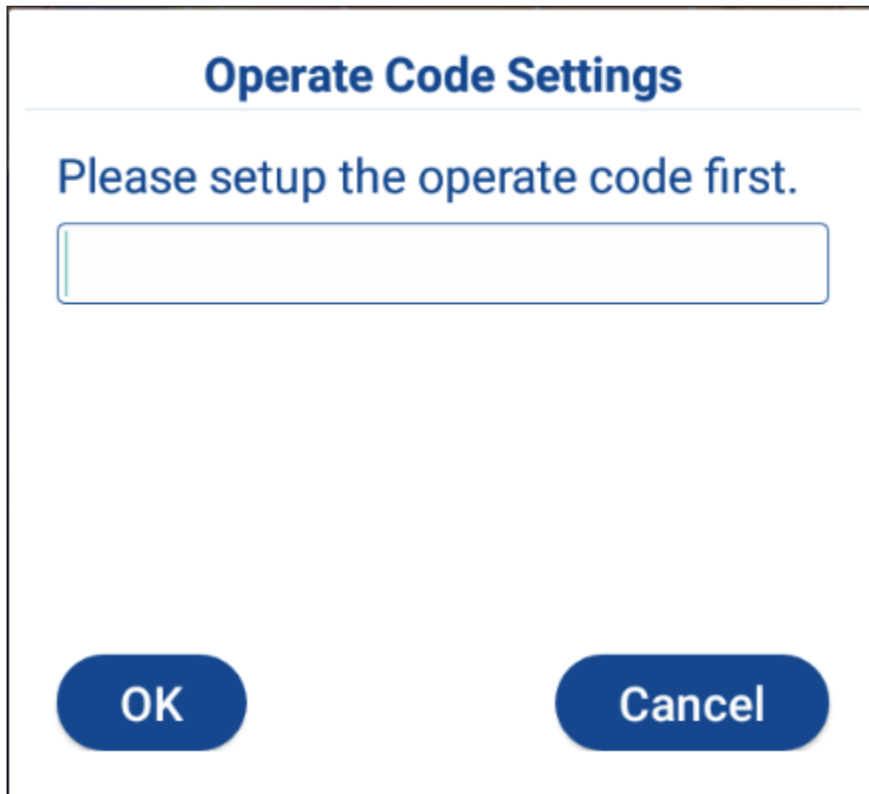

Data Sync

After the operate code is set, data synchronization will start automatically.

The number on the left shows the number of faces that have been synchronized, and the number on the right shows the number of faces to be synchronized.

After the synchronization is complete, you can start face recognition temperature measurement access control attendance.

Education Mode (cont.)

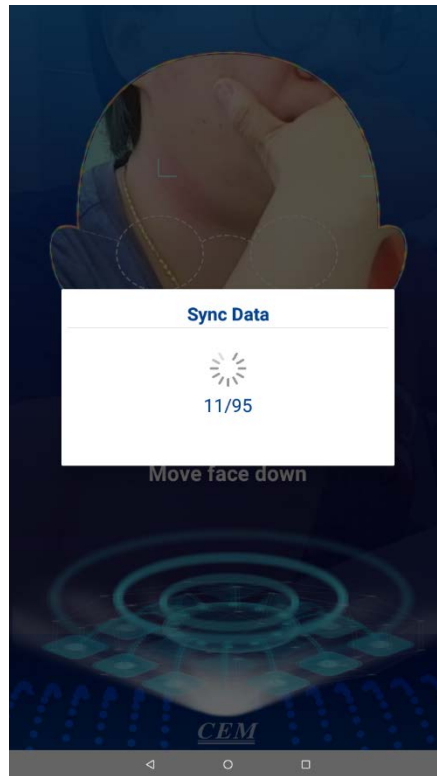

Note: If there are many faces in one synchronization, the synchronization time will take longer. Please be patient.

Menu Items

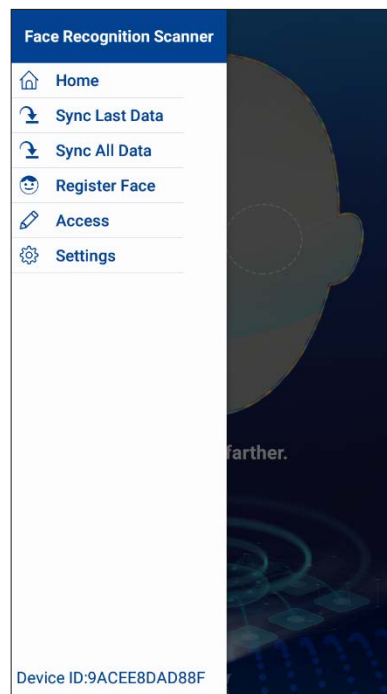

The Menu icon  is hidden on the homepage. To display it, you must double-tap the screen.

After clicking the menu icon, the interface for entering the operate code is displayed.

After the operate code is successfully verified, the menu item is displayed.

Education Mode (cont.)

Homepage

Click to return to the homepage.

Sync Last Data

The device only syncs the last modified or added user data and face photos.

Sync All Data

The device will clear the local cached data, and re-sync all user data and face photos. Please be patient, as this process may take an extended period of time.

Register Face

Through the Access Control & Attendance Management Platform Software, after entering the student information, you can choose to register the student's face on the device.

If the face photos entered into Access Control & Attendance Management Platform Software are unqualified and the students cannot perform face recognition, they can also choose to register faces on the device.

You can enter the Name/Class/Phone Number and conduct a search. After finding the corresponding student information, choose to register the face or re-register to enter the face.

Access

If the face cannot be recognized, you can choose Access to verify.

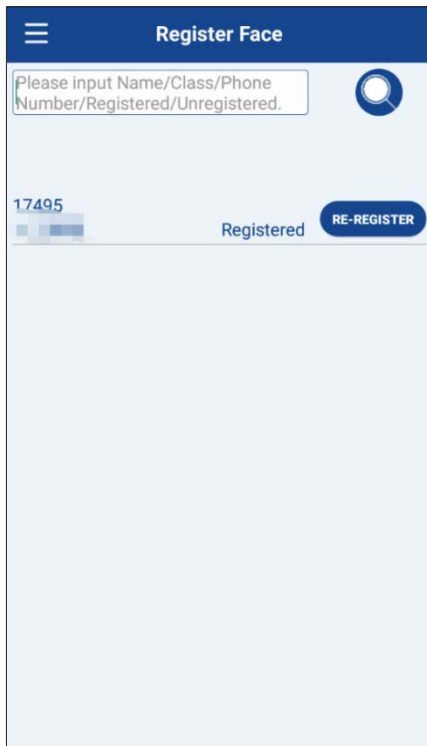
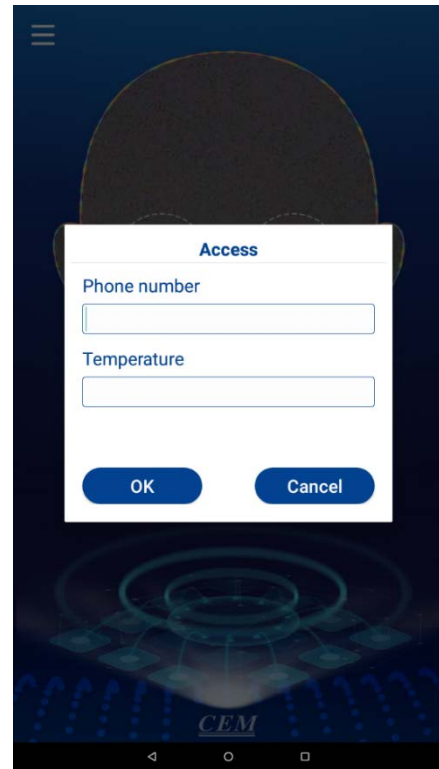

Settings

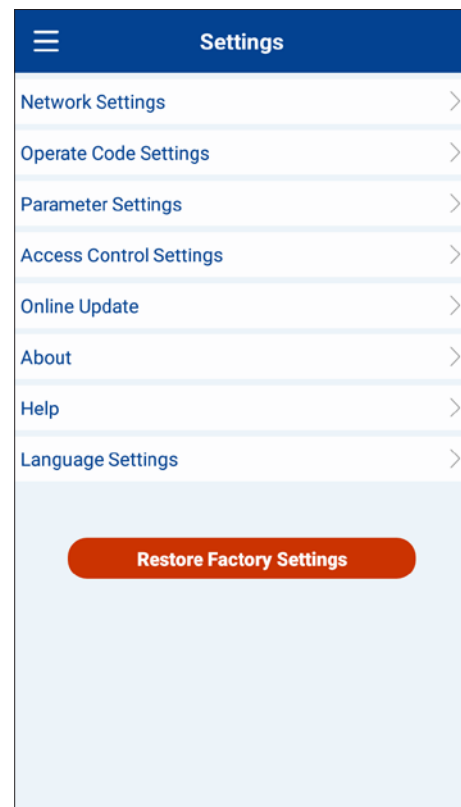

Education Mode (cont.)

Network Settings

Set up device networking.

Operate Code Setting

Modifying the operation code requires that the device is in the online state.

It can be viewed in the software / device management of the access control and attendance management platform to prevent forgetting the operation code.

Parameter Settings

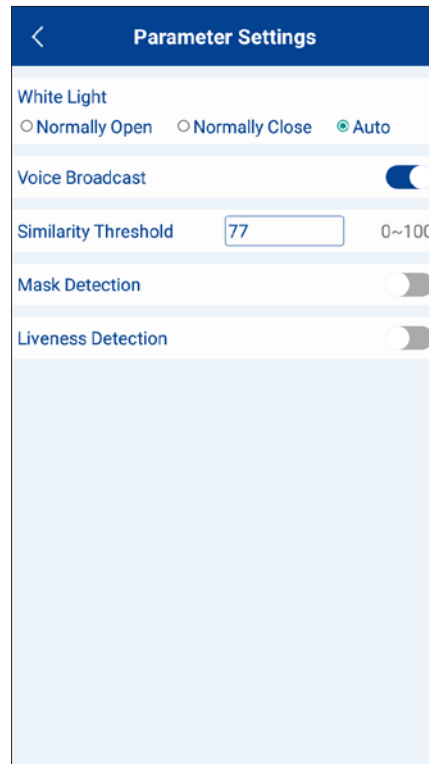

White Light

The white light can be set to normally open / normally closed / auto. When set to automatic, it will automatically adjust on/off according to whether there is face detection or not.

Voice Broadcast

Control the opening and closing of voice announcements.

Similarity Threshold

The threshold adjustment will affect the pass rate and false detection rate of face recognition.

If the face similarity threshold is set higher, the comparison will be stricter and the pass rate will be relatively reduced.

If the mask recognition threshold is set higher, it may lead to an unrecognizable scan. If the threshold is set lower, the false detection rate will increase. For example, if the original person is not entered and the threshold is set lower, it may be identified as another individual in the photo library that is similar to the person.

Mask Detection

When mask detection is enabled, only those wearing masks can pass. If someone is detected not wearing a mask, an alarm will be issued and they will not be able to pass.

When the liveness detection is enabled, the live detection infrared fill light will be performed after recognition. It can be set to normally open / normally closed / auto. When set to automatic, it will automatically adjust on/off according to whether there is face detection. Only pass the liveness detection to enter.

Education Mode (cont.)

Access Control Settings

The action time of the door lock can be set to specify long it will automatically close after the door is opened.

Door sensor type can be selected according to the actual installed door sensor type, either normally open / normally closed.

Door magnetic alarm - If the door is not opened or closed normally, the alarm will be triggered.

Online Update

Online upgrade requires that the device be connected to an external network.

Click Online Upgrade to automatically detect whether the software has a version update. If there is a version update, it will automatically update the latest version of the software.

About

Check device software version information.

Help

View instructions.

Language Settings

Change the system language.

Restore Factory Settings

Proceed with Caution - If you choose to restore the factory settings, the device will clear all data and restore to the state of initial use.

Access Control and Attendance - Quick Screen Mode

Quick Screening Mode performs temperature screening only when face recognition is not required. This mode is equipped with Temperature Cloud APP to monitor abnormal data and snapshots.

Scan the QR code below to download the Temperature Cloud APP and bind the device to view the data.



Temperature Cloud APP

Operation Process

To access Quick Screening Mode, click the following button.

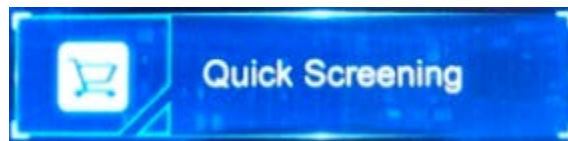

Add Device

Download the Temperature Cloud APP.

Add the device. Select “AI321” as the device type, and enter the device ID number, which must be the same as the ID number displayed on the device main interface.

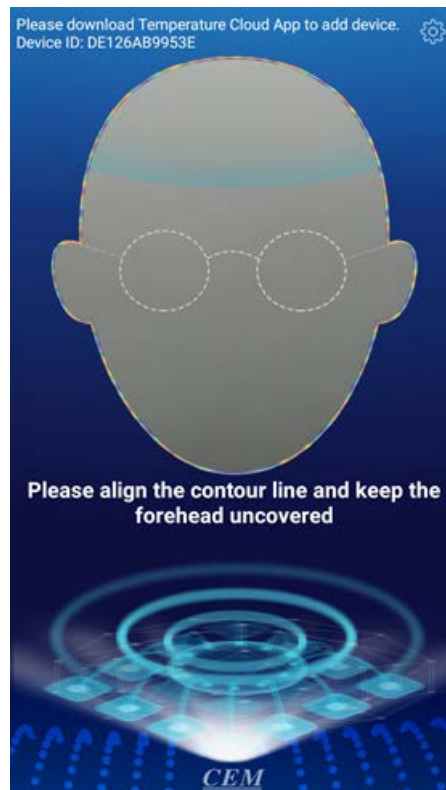

Quick Screen Mode (cont.)

Settings

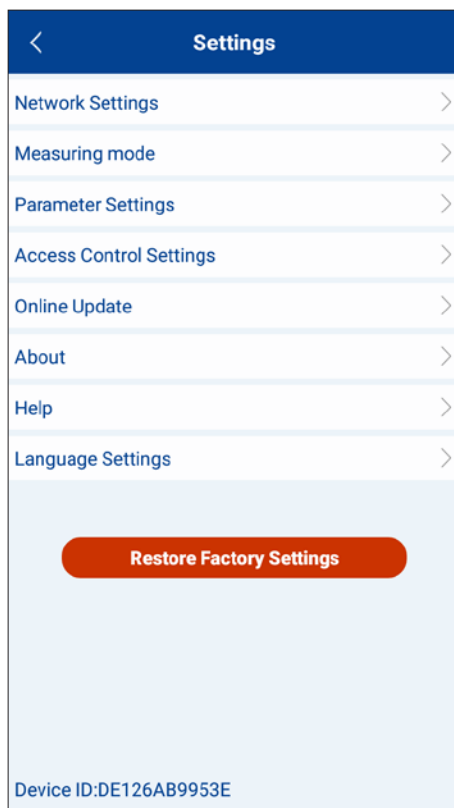

Select the main interface setting icon to enter the setting interface.

Network Settings

Configure device networking.

Measuring Modes

Two measuring modes are available:

Measuring Without Face Checking - Always display the temperature value without face detection, and broadcast the data within the temperature range of the human body.

Measuring After Face Checking - When a face is detected and the conditions are met, the temperature value will be displayed. The temperature range will be broadcast within the body temperature range.

Parameter Settings

White Light - The white light can be set to normally open / normally closed / auto. When set to automatic, it will automatically adjust on/off according to whether there is face detection or not.

Voice Broadcast - Control the opening and closing of voice announcements.

Access Control Settings

The action time of the door lock can be set to specify long it will automatically close after the door is opened.

Door sensor type can be selected according to the actual installed door sensor type, either normally open / normally closed.

Door magnetic alarm - If the door is not opened or closed normally, the alarm will be triggered.

Online Update

Online upgrade requires that the device be connected to an external network.

Quick Screen Mode (cont.)

Click Online Upgrade to automatically detect whether the software has a version update. If there is a version update, it will automatically update the latest version of the software.

About

Check device software version information.

Help

View instructions.

Language Settings

Change the system language.

Restore Factory Settings

Proceed with caution - If you choose to restore the factory settings, the device will clear all data and restore to the state of initial use.

Technical Specifications

Temperature measurement module parameters	
Measurement range	32°C~45°C/ 89.6°F~113°F
Measurement accuracy	±0.5°C/ ±0.9°F (at 25±2°C/ 77±3.6°F ambient temperature)
Measurement distance	8 in~20 in (20cm~50cm)
Measurement response	0.5s
Elevated temperature alarm point	99.1°F (37.3°C)
System hardware parameters	
Processor	ARM Cortex-A7 (Quad Core)
Operating system	Android 8.1
Memory size	1 GB
Storage size	16 GB
Camera Parameters	
Resolution	Color 200W (1920*1080), Infrared 130W (1280*960)
Imaging device	Color AR0230, Infrared AR0130
Lens	2.9mm
Recognition height	3 ft~6 ft (1m~2m)
Recognition distance	1 ft~4 ft (0.3m~1.2m)
Angle of view	Horizontal: 89° Vertical: 57° Diagonal: 98°
Face angle	±30°
Minimum illumination	Color ≥0.01LUX at F1.2, Infrared: ≥0.01LUX at F1.2
Signal to noise ratio	Color ≥4dB, Infrared: 44dB
Wide dynamic range	Color ≥105dB, Infrared: ≥83.5dB
Interface parameters	
Network interface	1 RJ45 (10/100 ethernet port)
USB interface	1 USB interface
Wireless connection	WiFi+BLE4.0
RS485 interface	1 RS485 interface
Relay interface	1 relay interface
Alarm door check button	1 fire alarm door check button
IO reserved	1 11pin terminal
Power supply	12V DC / 3A
Smart functions	
Face recognition capacity	50,000
Offline records	100,000
Recognition accuracy	99.83%
Live detection	Support binocular near infrared
Face detection	1080P @ 25fps, supports face detection tracking, optimization
Face recognition speed	Approx 200ms
Live detection speed	Approx 400ms
Basic parameters	
Screen size	7 in (178mm)
Product dimensions LxWxH	11 in x 5.4 in x 3 in (275 mm x 137 mm x 72.5 mm)
Operating humidity	10%~90%
Operating temperature	10°C~40°C / 50°F~140°F
Box Dimensions (L x W x H)	15.5 in x 9 in x 6 in (394 mm x 229 mm x 153 mm)
Box Weight	5.3 lbs (2.4 kg)

Installation Instructions

- For wall mounting, the TSCAN-750 is provided with a wall mount kit, which includes:
 - 1 Wall Mount Plate
 - 4 Wall Plugs
 - 4 KA 4x25 Screws
 - 4 KM 4x10 Screws
 - 4 Hex Screws
 - 4 Hex Nuts
 - 8 Flat Washers
 - 1 ¼-20 3/8” Phillips Screw
- For freestanding applications, most standard tripods/stands can be used with the TSCAN-750 by fixing the backplate to the stand using the existing holes and screws provided.
- Regardless of wall mount or freestanding installation, the TSCAN-750 is for indoor use only.

Box 86 for Wall-Mounted Installation

1. Install stickers on the wall, and make holes in the wall according to the height and position of the stickers to install Box 86.
2. Align the outlet of the hanging board with the center of Box 86. Punch four mounting holes on the wall according to the punching size diagram, and insert four wall plugs.
3. Use four KA 4*25 screws to fix the hanging board to the wall. Connect the cable of the external device to the cable, arrange the cables, and determine the cable outlet method.
4. Hook the device from top to bottom on the mounting plate, and make sure that the upper part of the hanging plate is inserted into the groove on the back of the device.
5. Fix the device and hanging plate from the bottom with a screw.

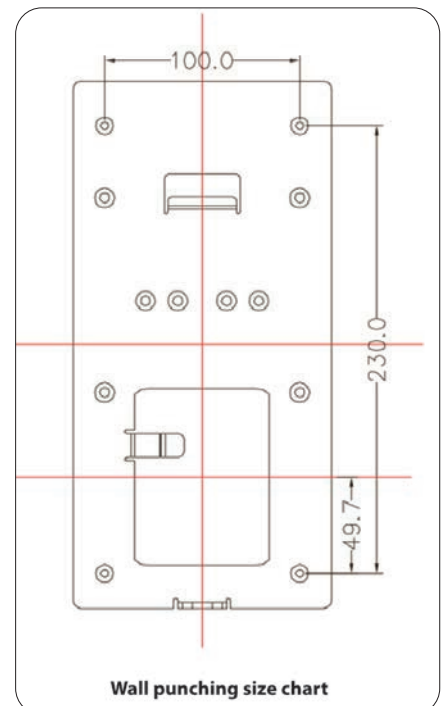
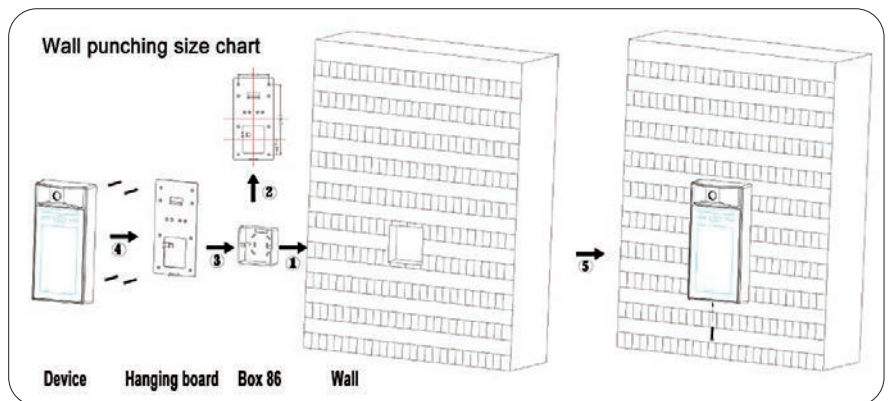

Installation Instructions (cont.)

Wall-Mounted Installation

1. Attach an installation sticker to the wall. Make holes in the wall according to the height and position of the sticker, insert a wall plug, and install four hex screws.
2. Fix the hanging board on the wall with four KM 4* 10 screws.
3. Hook the device from top to bottom on the hanging board, making sure that the upper part of the hanging board is inserted into the groove on the back.
4. Use a screw to fix the device and hanging plate from the bottom.

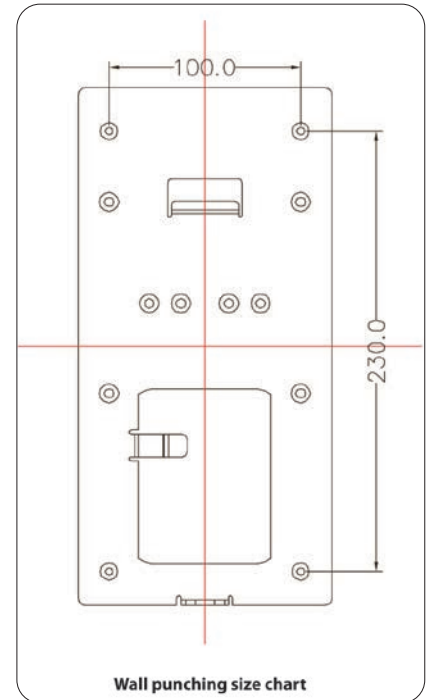
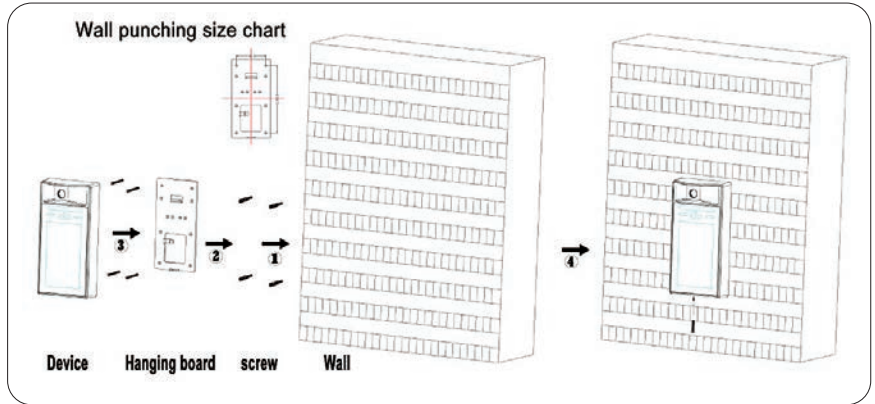

ADVANCE IR»»

967 Windfall Road
St. Marys, PA 15857 USA

AIR-INS5779C TSCAN-750 09/2020