

## SUMMARY

### # Wires

Low voltage 7



*Image is for illustrative purpose only*

Series 1B  
Termination type Male solder  
IP rating 50  
AWG wire size 30.00 - 26.00  
Cable Ø 3.10 - 4.20 mm  
Status active

### Download

[Request a quote](#)

## TECHNICAL DETAILS

### Mechanics

Shell Style/Model FG\*: Straight plug, cable collet  
Keying 1 key (alpha=0, plug: male contacts, receptacle: female contacts)  
Housing Material Brass (chrome plated [SAE AMS 2460]) shell and collet nut, nickel plated [SAE AMS QQ N 290] brass latch sleeve and mid pieces  
Weight 12.30 g

### Performance

Configuration 1B.512 : 2x SPE - 4 High Speed, Low Voltage (1000BASE-T1 (IEEE 802.3bp)) + 3 Ground contacts  
Insulator T: PTFE  
Rated Current

### Others

Endurance (Shell): 5000  
Temp (min / max): -55 °C / +250 °C  
Humidity (max): <=95% [at 60 deg C /140 F]

*LEMO products and services are provided "as is". LEMO makes no warranties or representations with regard to LEMO product & services or use of them, express, implied or statutory, including for accuracy, completeness, or security. The user is fully responsible for his products and applications using LEMO components.*

Vibration: 15 g [10 Hz - 2000 Hz]  
 Shock Resistance: 100 g [ 6 ms]  
 Climatical Category: 50/175/21  
 Shielding (min): 75 dB (10 MHz)  
 Shielding (min): 40 dB (1 GHz)  
 Salt Spray Corrosion: >1000 hr

## DRAWINGS

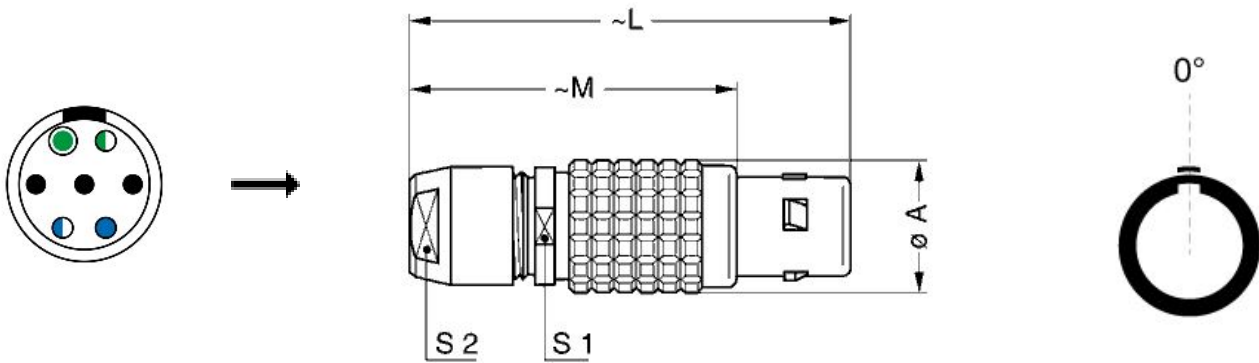

### Dimensions

	A	L	M	S1	S2
mm.	12	43	32	10	9
in.	0,47	1,69	1,26	0,39	0,35

## RECOMMENDED BY LEMO

### Tools

Spanner wrench: [DCD.1B.ZZZ.PA090](#)

Caps: [BFG.1B.100.PCSG](#)

*LEMO products and services are provided "as is". LEMO makes no warranties or representations with regard to LEMO product & services or use of them, express, implied or statutory, including for accuracy, completeness, or security. The user is fully responsible for his products and applications using LEMO components.*