

# E-SERIES RECOGNIZED

## Constant Voltage Electronic Phase-Dimmable LED Driver

P/N: E  

The E-Series Recognized is an electronic Class 2 dimmable LED driver with an extremely compact low-profile aluminum case, making it the perfect choice for under-cabinet lighting, kick/cove lighting, mirror lighting, and multiple other residential and commercial lighting applications. The driver features auto reset, over current and short circuit protection, as well as an efficiency of over 90% resulting in low operating case temperature. The product line is phase-dimmable down to 1% with leading edge TRIAC dimmers.



4.92" L x 2.20"W x 0.79"H



**Installation:** Wire leads

**Driver Type:** Class 2 Single Channel

**Dimming:** Phase-dimmable down to 1% with leading edge TRIAC Dimmer

**Input Voltage:** 120VAC, 50/60Hz

**Output Voltage:** 12VDC or 24VDC

**Environmental:** Wet location

**IP Rating:** IP67

**Listing:** UL Recognized

**Certifications:** UL8750 | CSA C22.2 No. 250 13-14

**Component Signage**

**Listing Certification:** UL 879 | CSA C22.2 No. 207-M89

**Warranty:** 5-Year

E-SERIES is also available in:

- ♦ E-SERIES UL LISTED
- ♦ EZJ-BOX
- ♦ JB-SERIES

Please refer to our website at [Magnitudeinc.com](http://Magnitudeinc.com) for more information.

**ORDERING GUIDE** Example: E20R12DC

E\_\_R\_\_DC

TYPE	MAX POWER	LISTING	OUTPUT
E — E-SERIES	20 — 20W	R — UL Recognized Enclosure	12DC — 12VDC
	40 — 40W		24DC — 24VDC
	60 — 60W		
	75 <sup>1</sup> — 75W		
	96 <sup>1</sup> — 96W		
	<sup>1</sup> 24VDC only		

DIMENSIONS	
LENGTH	4.92" (125.0mm)
WIDTH	2.20" (56.0mm)
HEIGHT	0.79" (20.0mm)

**ACTUAL SIZE OF DRIVER →**

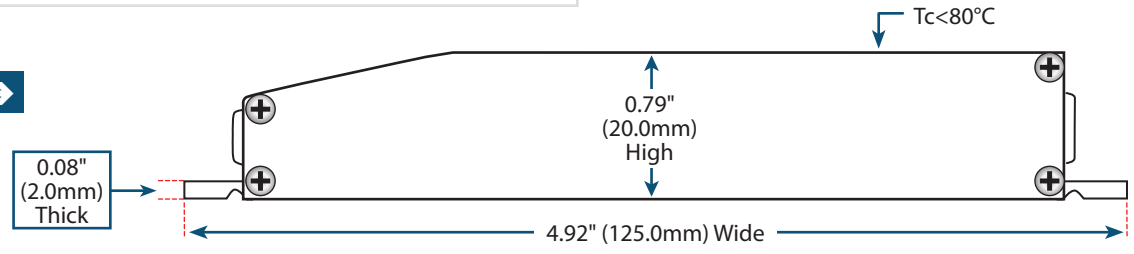

# E-SERIES RECOGNIZED

## Constant Voltage Electronic Phase-Dimmable LED Driver

### SPECIFICATIONS

INPUT	20W	40W	60W	75W	96W
Input Voltage Range	120VAC ± 10%	120VAC ± 10%	120VAC ± 10%	120VAC ± 10%	120VAC ± 10%
Input Frequency	50 / 60Hz	50 / 60Hz	50 / 60Hz	50 / 60Hz	50 / 60Hz
Input Current	0.20A@120VAC (12VDC) 0.20A@120VAC (24VDC)	0.41A@120VAC (12VDC) 0.41A@120VAC (24VDC)	0.61A@120VAC (12VDC) 0.61A@120VAC (24VDC)	0.72A@120VAC	0.85A@120VAC
Efficiency	> 90% (12VDC) > 90% (24VDC)	> 90% (12VDC) > 90% (24VDC)	> 90% (12VDC) > 90% (24VDC)	> 90%	> 90%
Power Factor	0.95	0.95	0.95	0.95	0.95
<b>OUTPUT</b>					
Max Load	20W	40W	60W	75W	96W
Output Voltage @ Max Load	12.0 VDC 24.0 VDC	12.0 VDC 24.0 VDC	12.0 VDC 24.0 VDC	24.0 VDC	24.0 VDC
Output Current @ Max Load	1.7A (12VDC) 0.90A (24VDC)	3.50A (12 VDC) 1.75A (24VDC)	5.00A (12VDC) 2.63A (24VDC)	3.3A	4.16A
<b>ENVIRONMENTAL</b>					
Max Ambient Temperature	-30°C - +40°C (-22°F - 104°F)				
<b>DIMMING</b>					
Minimum Dimming Level	1%	1%	1%	1%	1%
<b>PROTECTION</b>					
Circuit Breaker	Short circuit & over-voltage auto-reset				
<b>MECHANICAL HOUSING</b>					
Primary Leads	18AWG	18AWG	18AWG	18AWG	18AWG
Secondary Leads	14AWG	14AWG	14AWG	14AWG	14AWG
Length	4.92" (125.0mm)	4.92" (125.0mm)	4.92" (125.0mm)	4.92" (125.0mm)	4.92" (125.0mm)
Width	2.20" (56.0mm)	2.20" (56.0mm)	2.20" (56.0mm)	2.20" (56.0mm)	2.20" (56.0mm)
Height	0.79" (20.0mm)	0.79" (20.0mm)	0.79" (20.0mm)	0.79" (20.0mm)	0.79" (20.0mm)
Weight	9 oz. (255g)	9 oz. (255g)	9 oz. (255g)	9 oz. (255g)	9 oz. (255g)
Housing Material	Anodized Aluminum				
Housing Color	Blue				
Junction Box	No				
Mounting	One hole flange mount and one half-hole flange mount.				
<b>APPROVAL MARKINGS</b>					
Certificates/Approval Signs	UL8750 Class 2	UL8750 Class 2	UL8750 Class 2	UL8750 Class 2	UL8750 Class 2

# E-SERIES RECOGNIZED

## Constant Voltage Electronic Phase-Dimmable LED Driver

### MECHANICAL DIAGRAMS

TOP VIEW

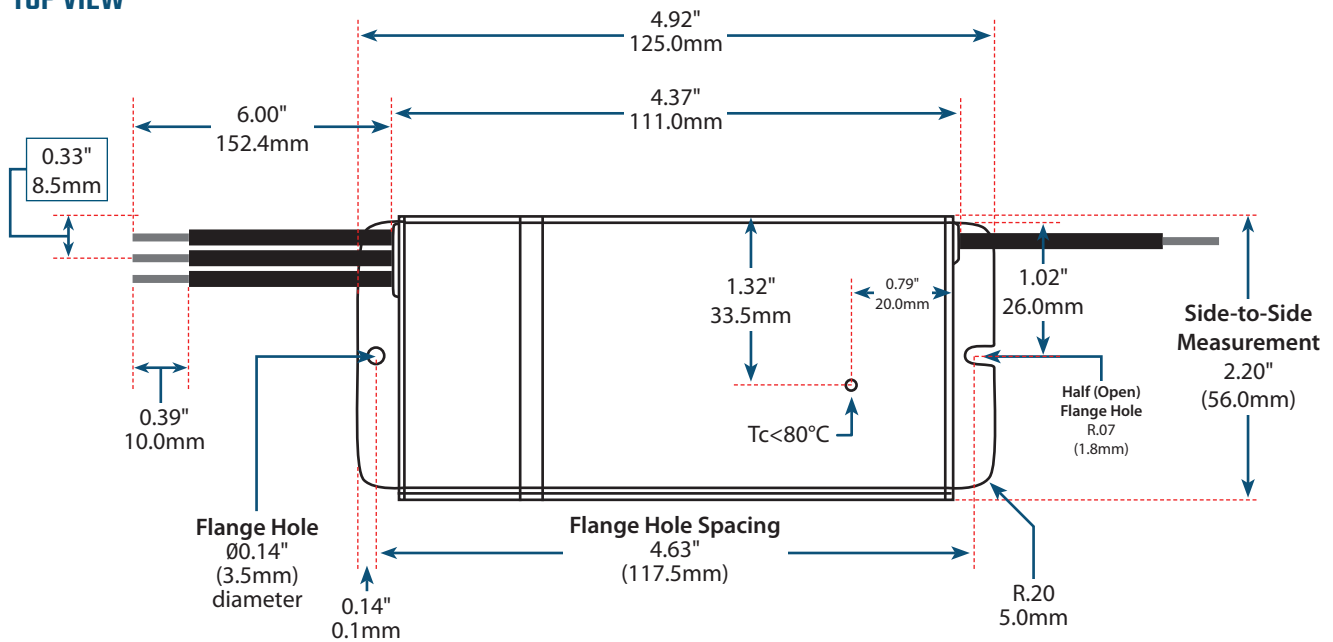

SIDE VIEW

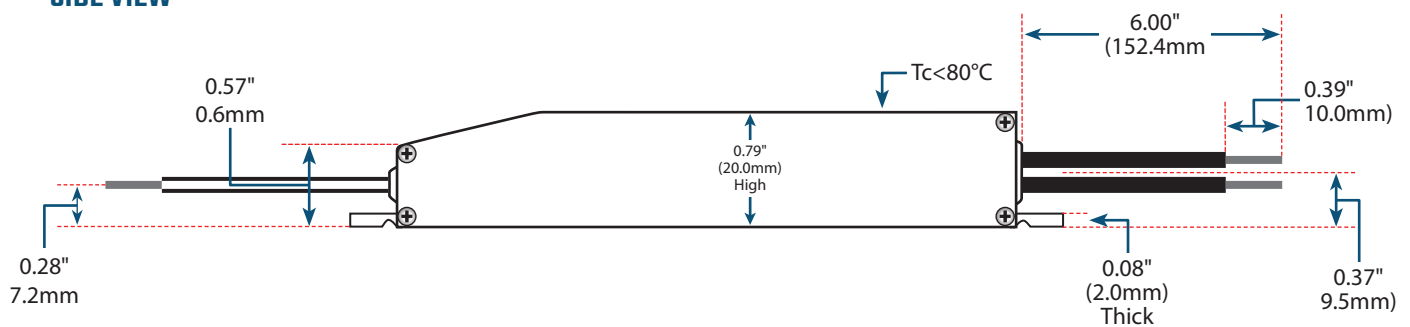

# E-SERIES RECOGNIZED

## Constant Voltage Electronic Phase-Dimmable LED Driver

**LOAD REGULATION**  
**20W & 40W**

**20W (12VDC)**

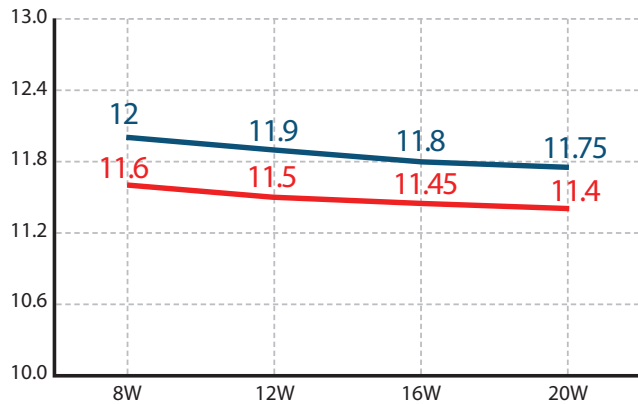

— Output Voltage vs. Load  
 — Output Voltage with a typical TRIAC Dimmer (on Max)

**20W (24VDC)**

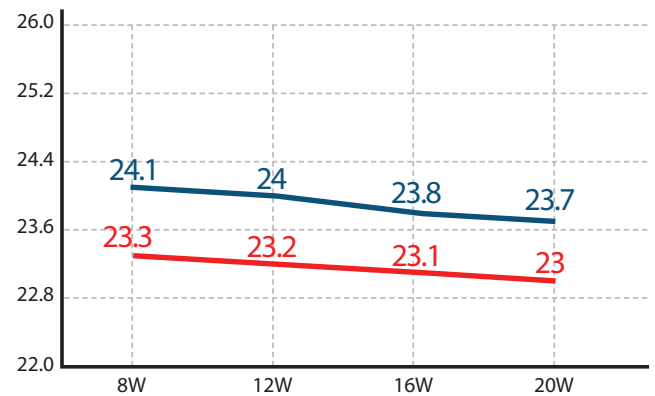

— Output Voltage vs. Load  
 — Output Voltage with a typical TRIAC Dimmer (on Max)

**40W (12VDC)**

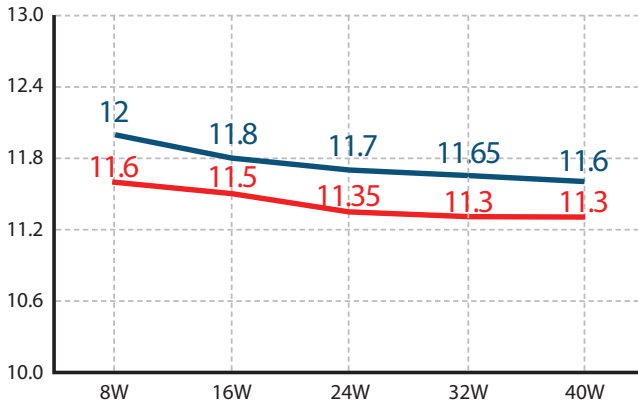

— Output Voltage vs. Load  
 — Output Voltage with a typical TRIAC Dimmer (on Max)

**40W (24VDC)**

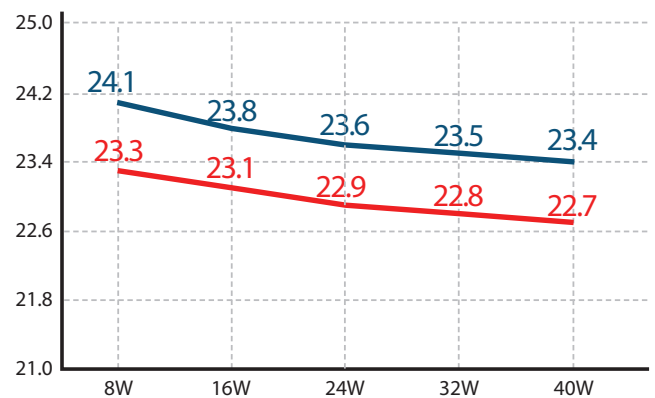

— Output Voltage vs. Load  
 — Output Voltage with a typical TRIAC Dimmer (on Max)

# E-SERIES RECOGNIZED

## Constant Voltage Electronic Phase-Dimmable LED Driver

**LOAD REGULATION**  
**60W, 75W & 96W**

**60W (12VDC)**

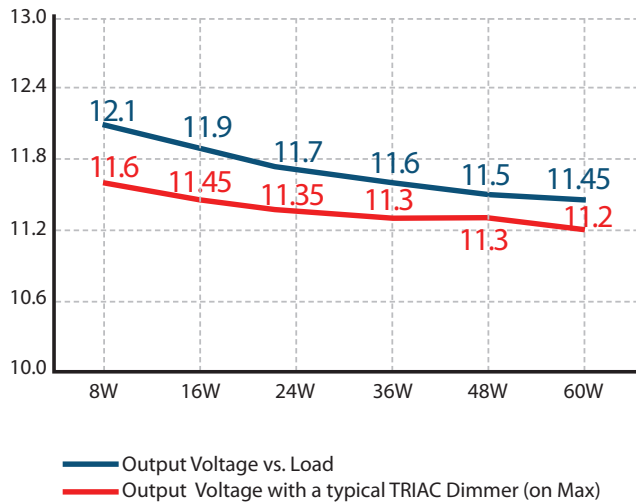

**60W (24VDC)**

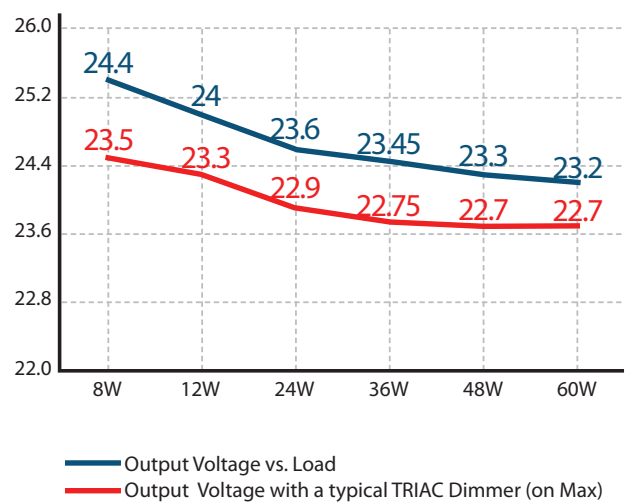

**75W (24VDC)**

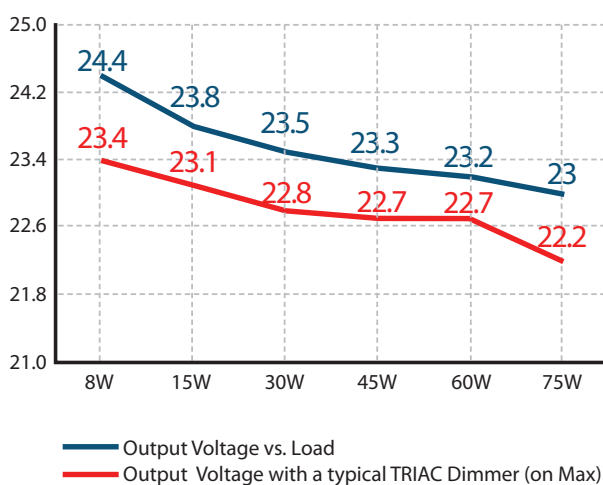

**96W (24VDC)**

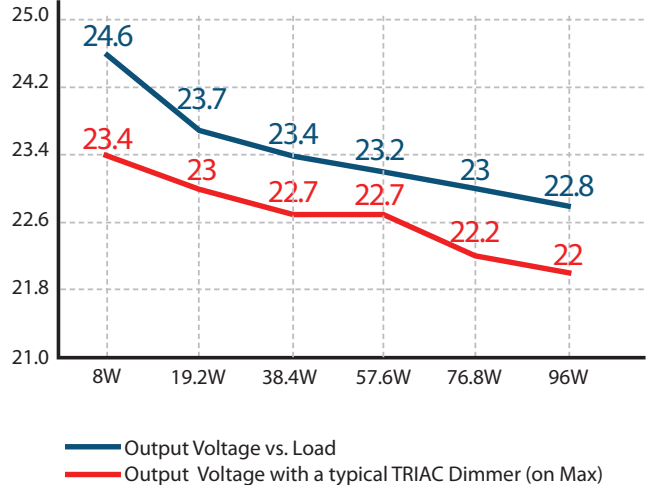

# E-SERIES RECOGNIZED

## Constant Voltage Electronic Phase-Dimmable LED Driver

↓ WIRING DIAGRAMS ↓

### 12VDC OUTPUT

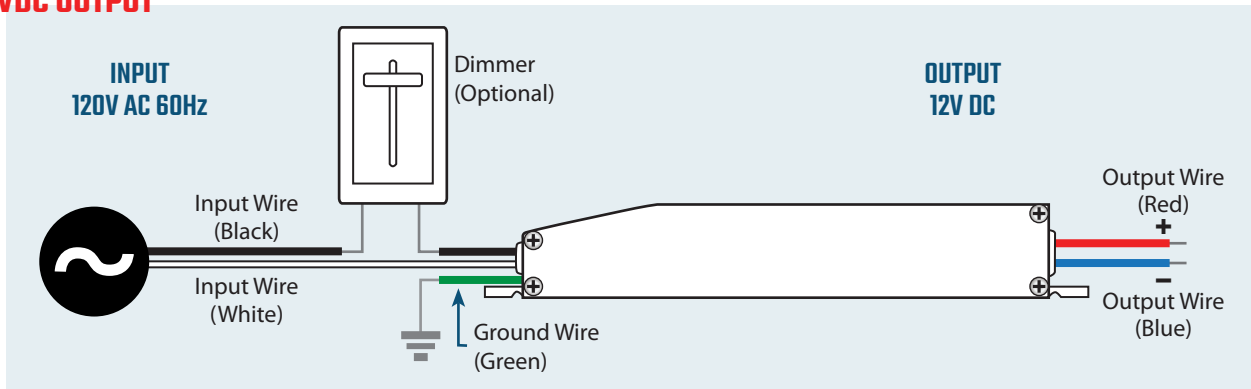

For smooth dimming, 8W minimum load is required.

### 24VDC OUTPUT

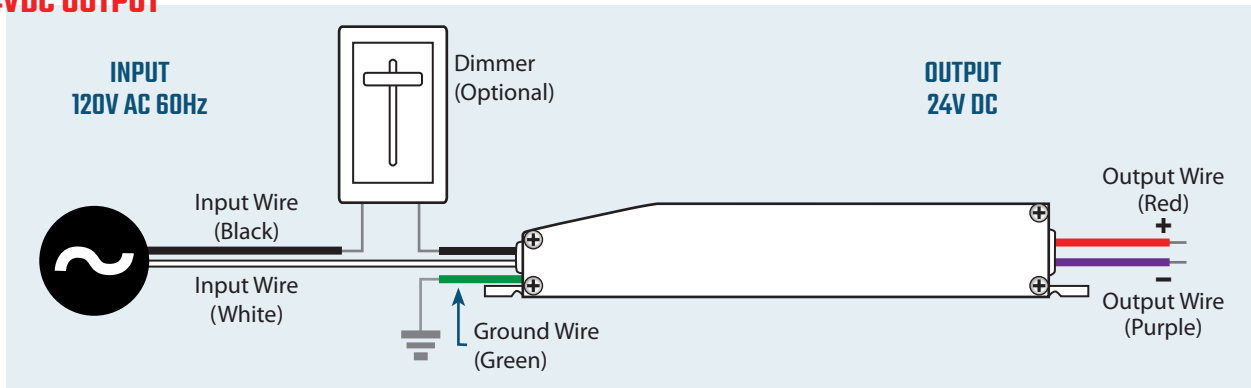

For smooth dimming, 8W minimum load is required.