

# CL1 Unipolar Current Regulator 5-20mA Temperature Compensated

May 2021

## Features

- Limits regulated current
- 5mA, 10mA, 15mA, 20mA versions
- Rejects 50Hz / 60Hz ripple
- Low pin count
- 250V maximum operating voltage
- Zero external components
- Can be paralleled for higher current

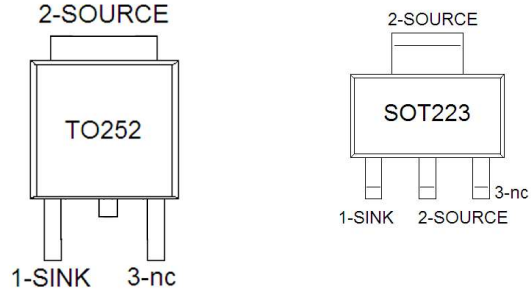

## Description

The CL1 product family are temperature compensated unipolar current regulators with versions available from 5mA to 20mA. It is designed to be used under a wide range of voltages, from 6V to 200V DC. The CL1 is primarily intended as a current limiting LED driver for serial LED applications in industrial lamp indicators, signage, accent and automotive lightning. Other applications include constant current source and sink.

The CL1 temperature coefficient is optimized from -40°C to 125°C. The CL1 will source or sink constant current. The CL1 will likely require a heat sink connected to the Source (pin 2).

## Absolute Maximum Ratings<sup>1</sup>

Maximum operating voltage <sup>2</sup> . . . . .	250V DC
Operating free air temperature range . . . . .	-40°C to 85°C
Storage Temperature . . . . .	-40°C to 85°C
ESD tolerance, human body model . . . . .	500V

Note 1: Stresses beyond “Absolute Maximum Ratings” may cause permanent damage to the device. These are stress ratings only, and functional operation of the device at these or any other conditions beyond those indicated under “Recommended Operating Conditions” is not implied. Exposure to absolute-maximum-rated conditions for extended period may impact device reliability.

Note 2: All voltages are with respect to Source.

## Recommended Operating Conditions

	Min	Max	Unit
Operating Voltage	6	200	V DC
Operating free air temperature	-40	85	°C
Operating chip temperature	-40	135	°C

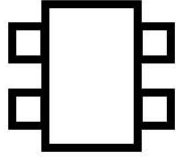

# CL1 Unipolar Current Regulator 5-20mA Temperature Compensated

May 2021

## Thermal Characteristics<sup>3</sup>

Ambient Temperature (25°C) unless otherwise specified

Parameter	Min	Typ	Max	Unit
SOT223 thermal resistance minimum copper layout		160		°C/Watt
SOT223 thermal resistance (0.60inch x 0.50inch)		88		°C/Watt
SOT223 thermal resistance (1.0inch x 1.0inch)		67		°C/Watt
TO252 thermal resistance minimum copper layout		110		°C/Watt
TO252 thermal resistance (0.60inch x 0.50inch)		75		°C/Watt
TO252 thermal resistance (1.0inch x 1.0inch)		50		°C/Watt

**Note 3:** Footprint copper layout size based on Package Heating Test Board (page 11)

## Terminal Definition

Terminal Name	Pin No.	Type	Description
Sink	1	HV Input	Sinks the load current
Source	2	VH Input	Usually Ground. Sources the load current.

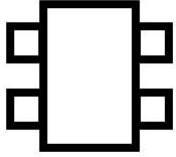

# CL1 Unipolar Current Regulator 5-20mA Temperature Compensated

May 2021

## Functional Block Diagram

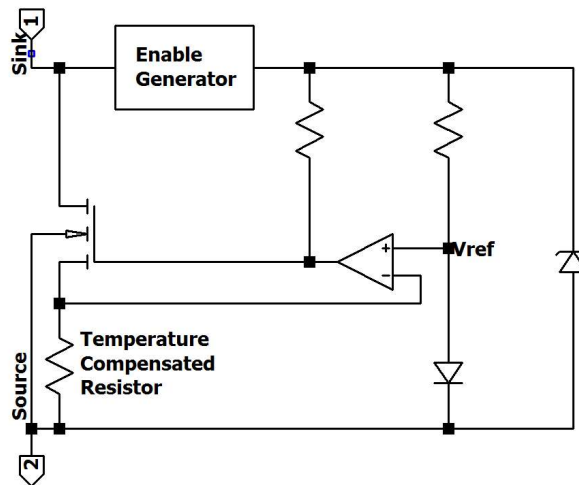

## Concept of Operation

This chip is powered by applying a voltage difference between Sink and Source terminal. As the voltage rises, the N-Channel MOSFET begins to conduct current between Sink and Source terminals. The temperature compensated source resistor senses this current and provides this feedback voltage to the non-inverting input of the operational amplifier. The operational amplifier compares the feedback voltage with the reference voltage provided by a p-n junction. The operational amplifier drives the gate of the N-channel MOSFET such that the feedback voltage and the reference voltage remain equal.

p-n junctions exhibit a negative temperature coefficient of approximately  $-2\text{mV}/^\circ\text{C}$ . The Source resistor is temperature compensated to match the temperature coefficient of the p-n junction. In this way, the regulated current flowing between Sink and Source will be (to a first order) independent of the chip junction temperature.

The power dissipated by the chip is given simply as  $I_{\text{lim}} * (V_{\text{Sink}} - V_{\text{Source}})$ . The chip will likely require a heat sink mechanically connected to the Source terminal (pin 2).

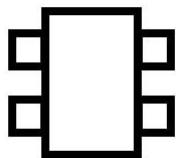

# CL1 Unipolar Current Regulator 5-20mA Temperature Compensated

May 2021

## Electrical Characteristics

$V_{\text{Sink}} - V_{\text{Source}} = 20\text{V}$ , Temp = 25°C unless otherwise specified

### 20mA nominal device

Parameter	Min	Typ	Max	Unit
Regulated Current ( $I_{\text{lim}}$ ) at 25°C	18.5	21.2	24.0	mA
Regulated Current ( $I_{\text{lim}}$ ) at -40°C		19.1		mA
Regulated Current ( $I_{\text{lim}}$ ) at +85°C		21.6		mA
Absolute Temperature Coefficient		24		$\mu\text{A} / ^\circ\text{C}$
Minimum Operating Voltage (limits current to 90% of $I_{\text{lim}}$ )	3.5	4.7	6.0	V
Voltage Coefficient 10V to 200V (pulse 10mSec)		1.0	2.0	mA / 100V
Stabilization time to 10% of final value		2.0		$\mu\text{Sec}$
Transient response 10% to 90%		300		nSec

### 15mA nominal device

Parameter	Min	Typ	Max	Unit
Regulated Current ( $I_{\text{lim}}$ ) at 25°C	13.9	15.9	18.0	mA
Regulated Current ( $I_{\text{lim}}$ ) at -40°C		14.3		mA
Regulated Current ( $I_{\text{lim}}$ ) at +85°C		16.2		mA
Absolute Temperature Coefficient		18		$\mu\text{A} / ^\circ\text{C}$
Minimum Operating Voltage (limits current to 90% of $I_{\text{lim}}$ )	3.0	4.2	5.5	V
Voltage Coefficient 20V to 250V (pulse 10mSec)		0.75	1.5	mA / 100V
Stabilization time to 10% of final value		2.0		$\mu\text{Sec}$
Transient response 10% to 90%		300		nSec

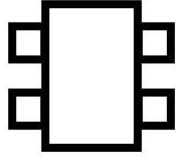

# CL1 Unipolar Current Regulator 5-20mA Temperature Compensated

May 2021

## Electrical Characteristics (cont.)

$V_{\text{Sink}} - V_{\text{Source}} = 20\text{V}$ , Temp = 25°C unless otherwise specified

### 10mA nominal device

Parameter	Min	Typ	Max	Unit
Regulated Current ( $I_{\text{lim}}$ ) at 25°C	9.3	10.6	12	mA
Regulated Current ( $I_{\text{lim}}$ ) at -40°C		9.5		mA
Regulated Current ( $I_{\text{lim}}$ ) at +85°C		10.8		mA
Absolute Temperature Coefficient		12		$\mu\text{A} / ^\circ\text{C}$
Minimum Operating Voltage (limits current to 90% of $I_{\text{lim}}$ )	2.5	3.7	5.0	V
Voltage Coefficient 20V to 250V (pulse 10mSec)		0.5	1.0	mA / 100V
Stabilization time to 10% of final value		2.0		$\mu\text{Sec}$
Transient response 10% to 90%		300		nSec

### 5mA nominal device

Parameter	Min	Typ	Max	Unit
Regulated Current ( $I_{\text{lim}}$ ) at 25°C	4.6	5.3	6.0	mA
Regulated Current ( $I_{\text{lim}}$ ) at -40°C		4.8		mA
Regulated Current ( $I_{\text{lim}}$ ) at +85°C		5.4		mA
Absolute Temperature Coefficient		6		$\mu\text{A} / ^\circ\text{C}$
Minimum Operating Voltage (limits current to 90% of $I_{\text{lim}}$ )	2.0	3.2	4.5	V
Voltage Coefficient 20V to 250V (pulse 10mSec)		0.25	0.5	mA / 100V
Stabilization time to 10% of final value		2.0		$\mu\text{Sec}$
Transient response 10% to 90%		300		nSec

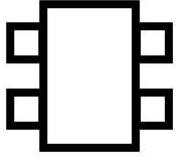

# CL1 Unipolar Current Regulator 5-20mA Temperature Compensated

May 2021

## Characteristic Curves (25°C, 20mA version)

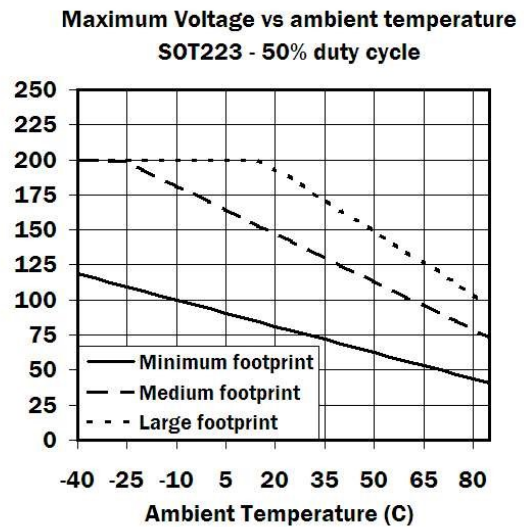
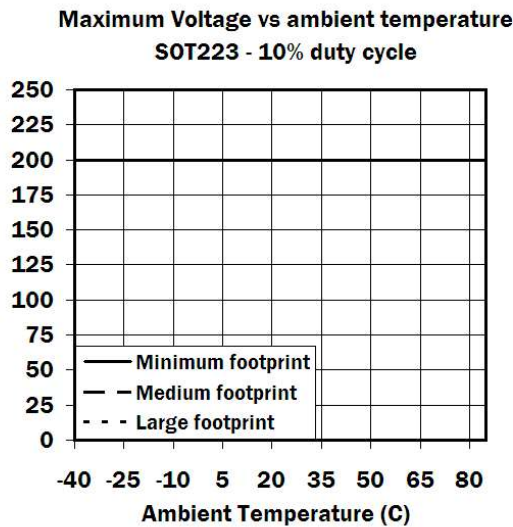
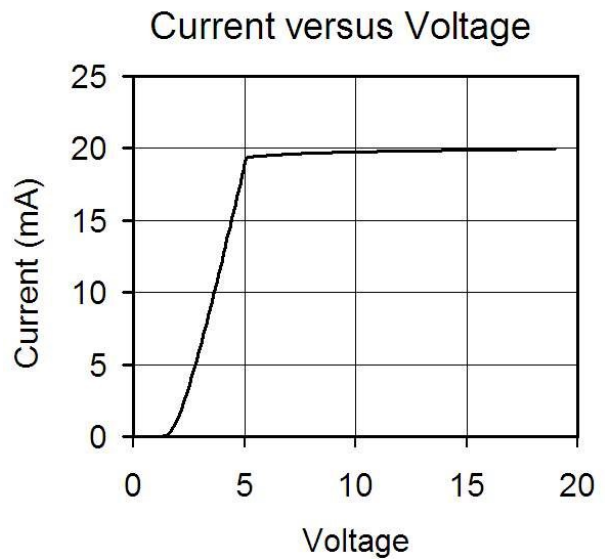
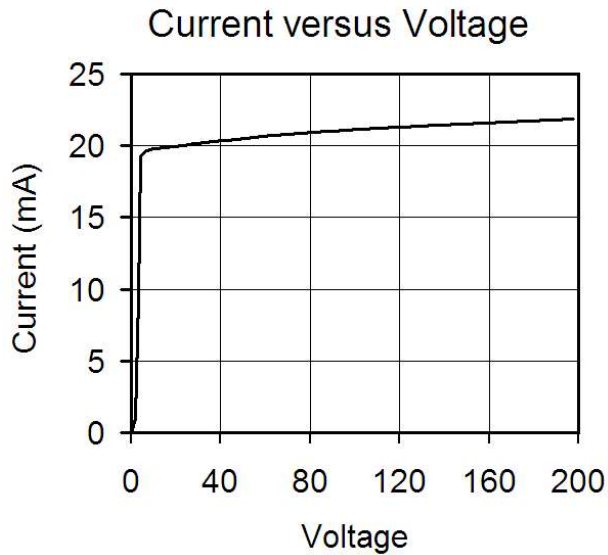

**Note 4:** Footprint size based on Package Heating Test Board (page 11)

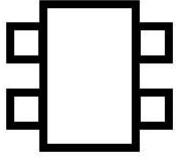

# CL1 Unipolar Current Regulator 5-20mA Temperature Compensated

May 2021

## Characteristic Curves (25°C, 20mA version)

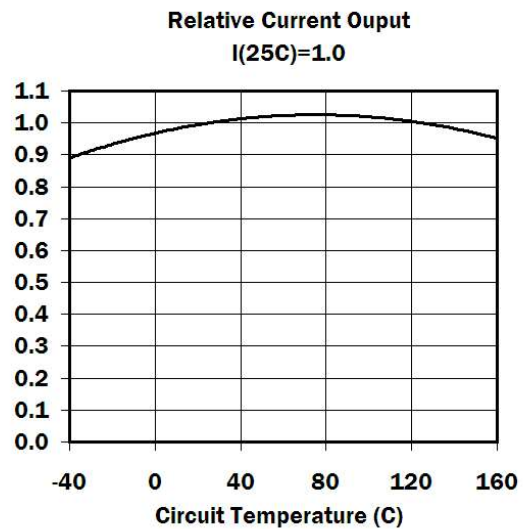
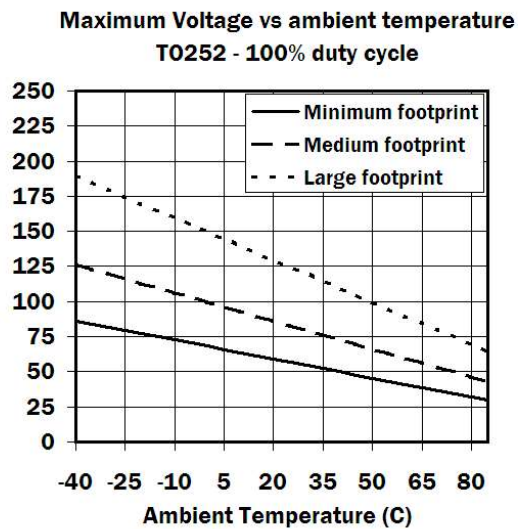
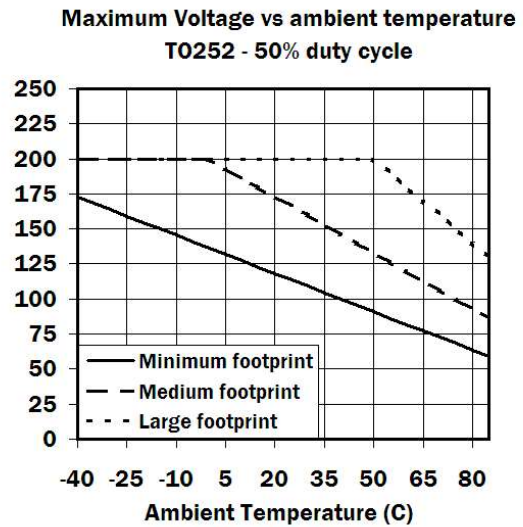
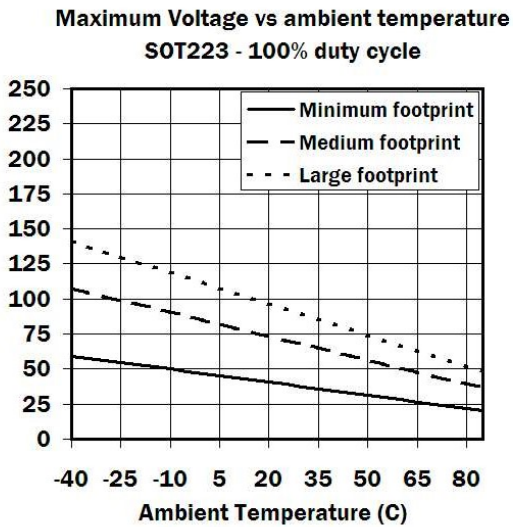

Note 5: Footprint size based on Package Heating Test Board (page 11)

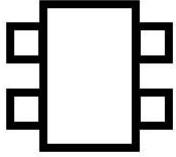

# CL1 Unipolar Current Regulator 5-20mA Temperature Compensated

May 2021

## Characteristics curves (25°C, 20mA version)

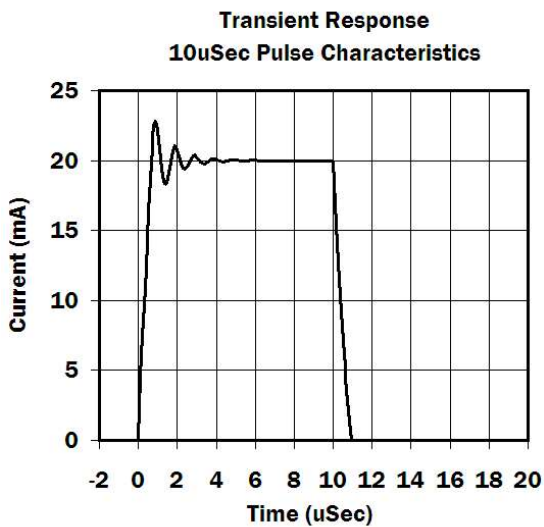
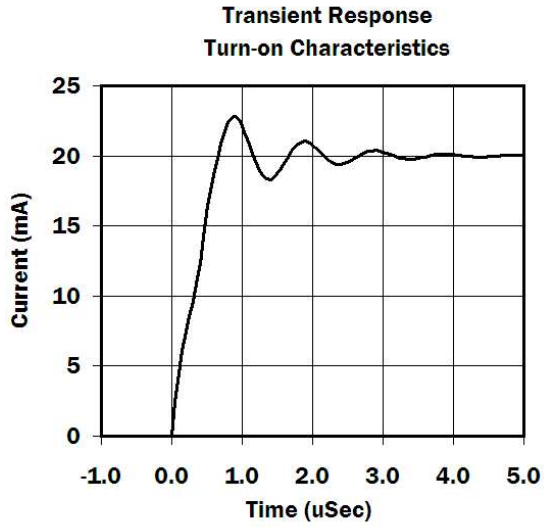
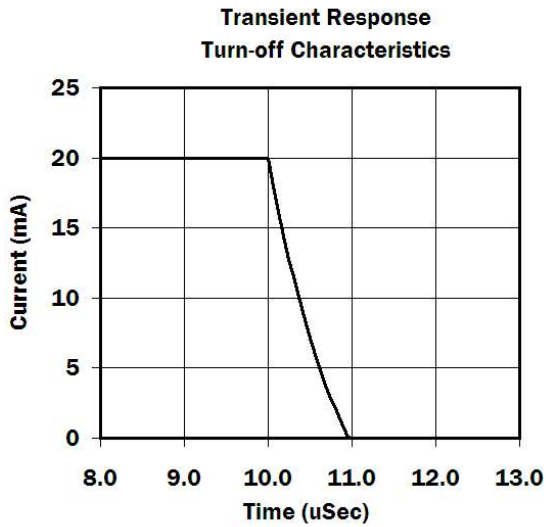



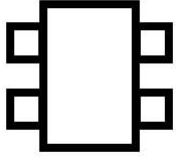

# CL1 Unipolar Current Regulator 5-20mA Temperature Compensated

May 2021

## Typical Application Circuits

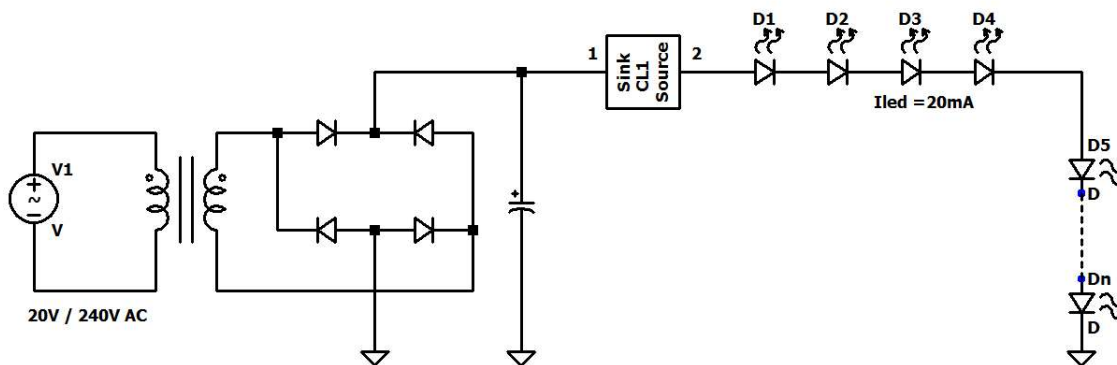
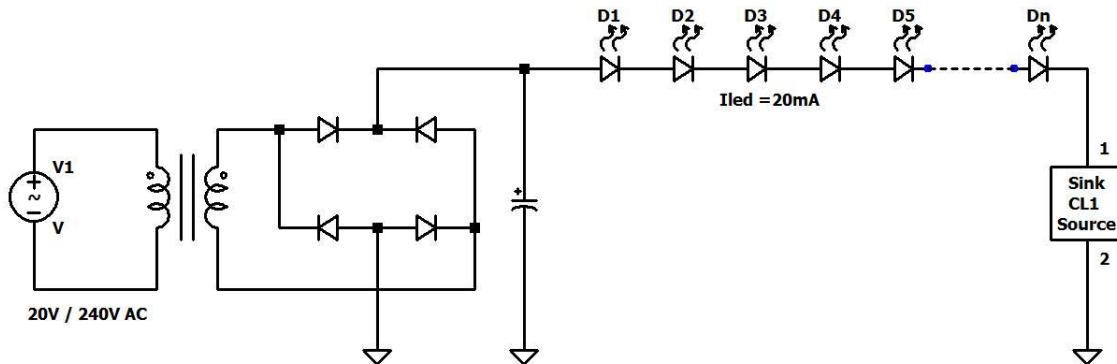

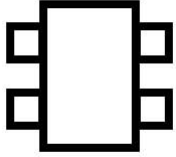

# CL1 Unipolar Current Regulator 5-20mA Temperature Compensated

May 2021

## Package Dimensions

### 3-Lead TO-252 (DPAK)

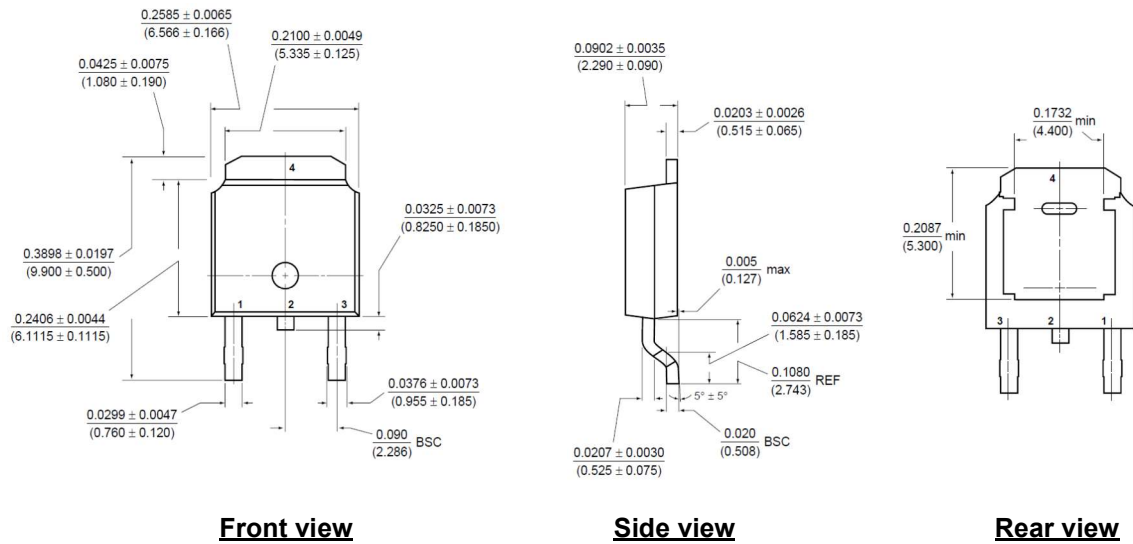

### 3-Lead SOT-223

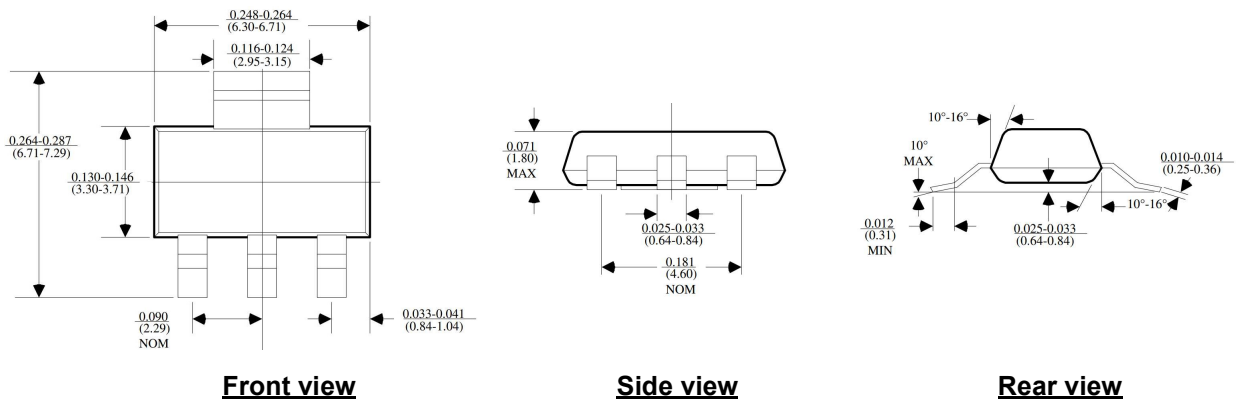

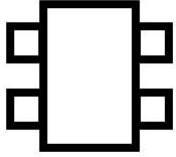

# CL1 Unipolar Current Regulator 5-20mA Temperature Compensated

May 2021

## Thermal properties test boards:

(Schematics not to scale)

