

IXOLAR™ High Efficiency SolarMD.

Description

IXOLAR™ SolarMD is an ANYSOLAR product line of Solar Module made of monocrystalline, high efficiency solar cells. The IXOLAR™ SolarMD is an ideal for charging various battery powered and handheld consumer products such as mobile phones, cameras, PDAs, MP3-Players and toys. They are also suitable for industrial applications such as wireless sensors, portable instrumentation and for charging emergency backup batteries.

With a cell efficiency of typically 25%, SolarMD gives the ability to extend run time even in "low light" conditions and increase battery life and run time in a small footprint, which can be easily accommodated in the design of portable products. The design allows connecting SolarMD flexibly in series and/or parallel to perfectly meet the custom-specific application's power requirements.

IXOLAR™ products have a very good photonic response over a wide range of wavelength and therefore can be used in both indoor and outdoor applications.

Product and Ordering Information

Part Number	Open Circuit Voltage [V]	Short Circuit Current [mA]	Typ. Voltage @ P _{mpp} [V]	Typ. Current @ P _{mpp} [mA]
SM141K06LV	4.15	58.6	3.35	55.1

(Parameters given are typical values)
 Dimensions (W x L x H): 45 x 22 x 1.8 ±0.3 [mm]
 SolarMD Weight: 3.4 grams
 Storage Temperature: -40°C ~ +90°C
 Operation Temperature: -40°C ~ +90°C
 SolarMD are compliant to the RoHS Norm.

SolarMD Electrical Characteristics

Symbol	Cell Parameter	Typical Ratings *)	Units
V _{oc}	open circuit voltage	4.15	V
I _{sc}	short circuit current	58.6	mA
V _{mpp}	voltage at max. power point	3.35	V
I _{mpp}	current at max. power point	55.1	mA
P _{mpp}	maximum peak power	184	mW
FF	fill factor	> 70	%
η	solar cell efficiency	25	%
ΔV _{oc} /ΔT	open circuit voltage temp. coefficient	-10.4	mV/K
ΔI _{sc} /ΔT	max power temp. coefficient	26.5	uA /K

*) All values measured at Standard Condition: 1 sun (= 1000 W/m²), Air Mass 1.5, 25°C

ANYSOLAR reserves the right to change limits, test conditions and dimensions

© 2010 ANYSOLAR All rights reserved

ANYSOLAR LTD.

IX-Tower #C-B218, 27, Dongtancheomdansaneop 1-ro,
 Hwaseong-si, Gyeonggi-Do, Republic of Korea [18469]
 Phone +82-31-784-8810, Fax +82-31-788-8811

1

Rev. Jan 2022

<http://www.anysolar.biz>

Features

- Monocrystalline silicon technology
- High efficiency outdoor and indoor
- Long life and stable output
- Sealed Package
- High mechanical robustness

Applications

- Battery chargers for portables such as cell phones, GPS-Systems, Energy Harvesting.
- "Green" electricity generation
- Power backup for IoT, Sensors, Wearables

Advantages

- One Product for Multiple Applications
- Flexible Integration into the Application

Typical SolarMD Performance Data

Current-Voltage Characteristics

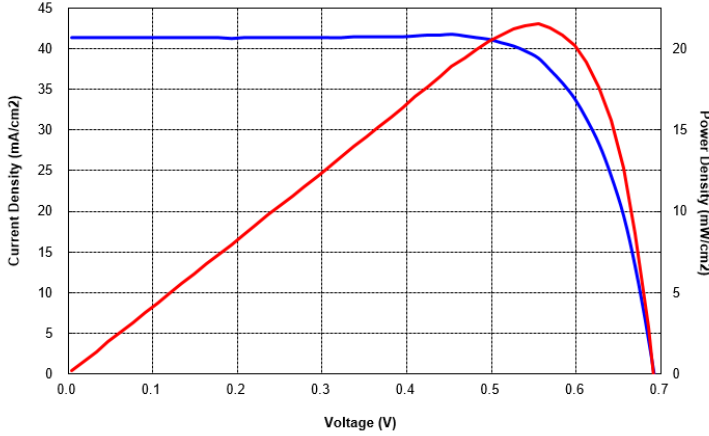

Short Circuit Current Density vs. Temperature

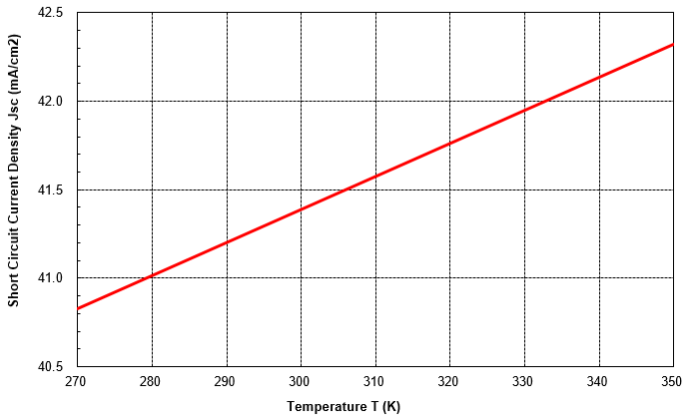

Open Circuit Voltage vs. Temperature

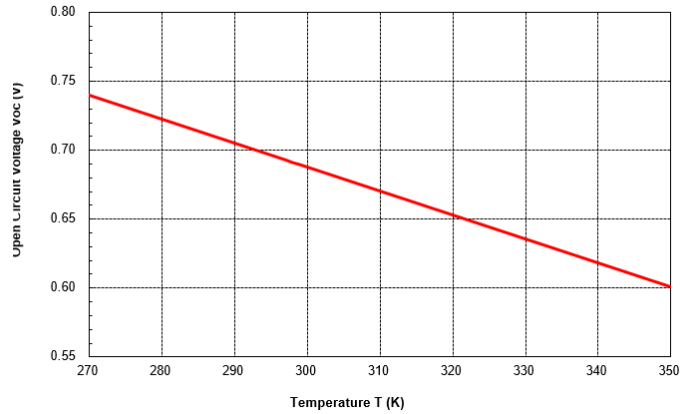

Open Circuit Voltage vs. Irradiance

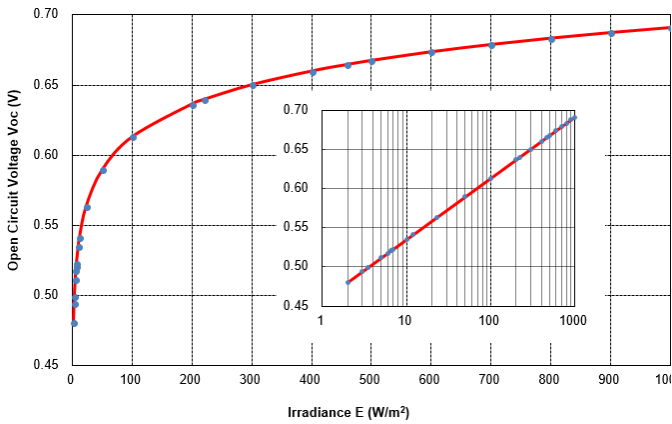

External Quantum Efficiency

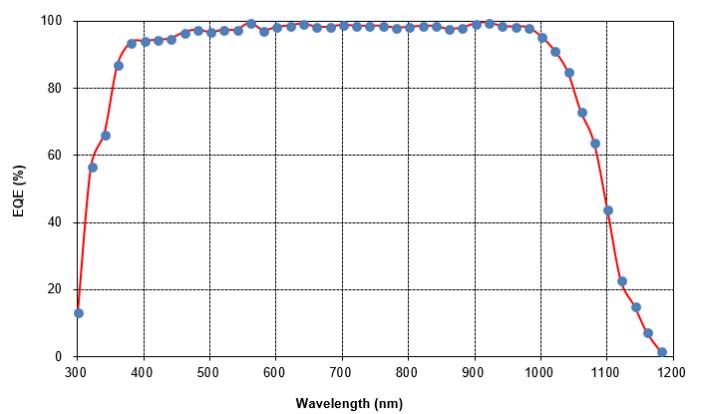

Package front-side and back-side view. (dimensions in millimeters)

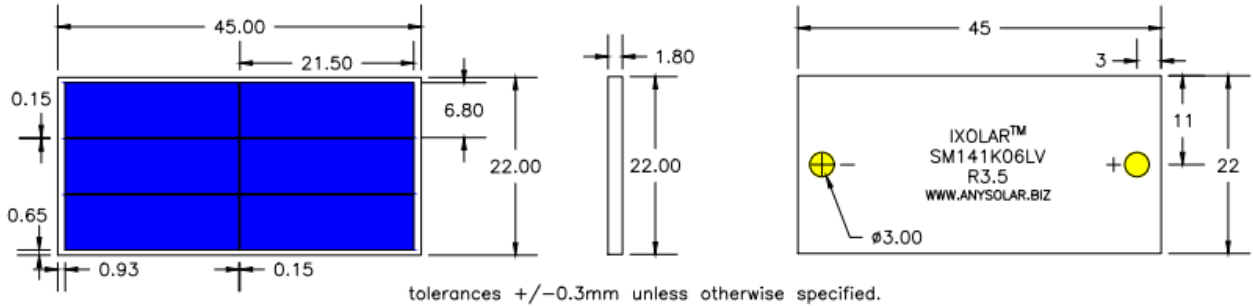

Front-side View details

Back-side View details

Moisture Sensitivity, Reflow Soldering and Washing Information

ANYSOLAR has characterized the moisture reflow sensitivity of the film laminated SolarMD. Moisture uptake from atmospheric humidity occurs by diffusion. During the soldering process to the electrode, the combination of moisture uptake and high temperature soldering may lead to moisture induced delamination and cracking of the component. To avoid this, this component must be handled with care when soldering. The film laminated SolarMD is not recommended for high temperature surface mount soldering reflow. SolarMD is encapsulated with EVA and polymer film by the lamination and thus excessively high temperatures soldering reflow is prohibited. Instead, manual soldering is recommended for 2 sec below 260°C. Delamination or blistering may sometimes be seen during manual soldering, then the part has most likely already absorbed moisture. In this case, prebaking is recommended in a dry oven at 140°C for 1 hour to avoid potential blistering or delamination. ANYSOLAR does not recommend the use of chlorine-based solvents for washing.

★IF YOU HAVE ANY DIFFICULTIES WITH SOLDERING, PLEASE CONTACT US AT THE EMAIL;

techdevelop@anysolar.biz

Background

Some basic information needs to be covered to better understand what to expect in terms of the SolarMD's performance with regards to solar cell type, lighting conditions in terms of power density, and general industry standards as they relate to battery charging.

Solar Cell Types

Keep in mind these cost and performance tradeoffs when comparing various solar cell materials:

Polycrystalline cells are commonly found in outdoor applications and have a spectral sensitivity range of 500nm to 1100nm. They're in the medium price range and typically offer a 13% power conversion efficiency.

Monocrystalline cells, such as the ANYSOLAR SolarMD, have a spectral sensitivity range from 300 nm (near-ultraviolet) to 1100 nm (near-infrared), which includes visible light (400 to 700 nm). Due to this wide spectral range, they can be used in both indoor and outdoor applications. Monocrystalline or single-crystalline material is the most expensive but it does not contain impurities, and as such the power conversion efficiency does not degrade over operating time. The power conversion efficiency of commercially available monocrystalline cells ranges from 15 to 25%. The surface of these cells is a homogenous dark blue or dark grey.

Finally, amorphous cells, which work in the spectral range of 300nm to 600nm, are used predominantly indoors in products such as solar powered calculators since they are not sensitive to the upper light spectrum and cannot take advantage of natural sunlight. They offer about 5% power conversion efficiency and are mostly used with ultra low power devices like clocks and electronic calculators. Amorphous cells, like polycrystalline cells, suffer from efficiency degradation.

SolarMD Description

SolarMD is made of monocrystalline, high-efficiency solar cells in a surface mountable package. They're robust and can be used in harsh environments. Solar cells used in SolarMD have a very high (25%) power conversion efficiency, which means that 25% of the light energy is converted into electrical energy. They're extremely useful in applications requiring solar power generation in a limited space.

Monocrystalline cells can be used in indoor and outdoor applications because they have a wide spectral sensitivity, 300 to 1100 nm. However, the output power of a solar cell is proportional (over a wide range) to the incoming light energy, and irradiance is generally much higher outdoors. The values in the data sheet are measured at "standard condition" of 1 sun, which is equal to 1000W per square meter sunlight irradiance at a defined light spectrum (air mass of 1.5) and 25°C cell temperature.

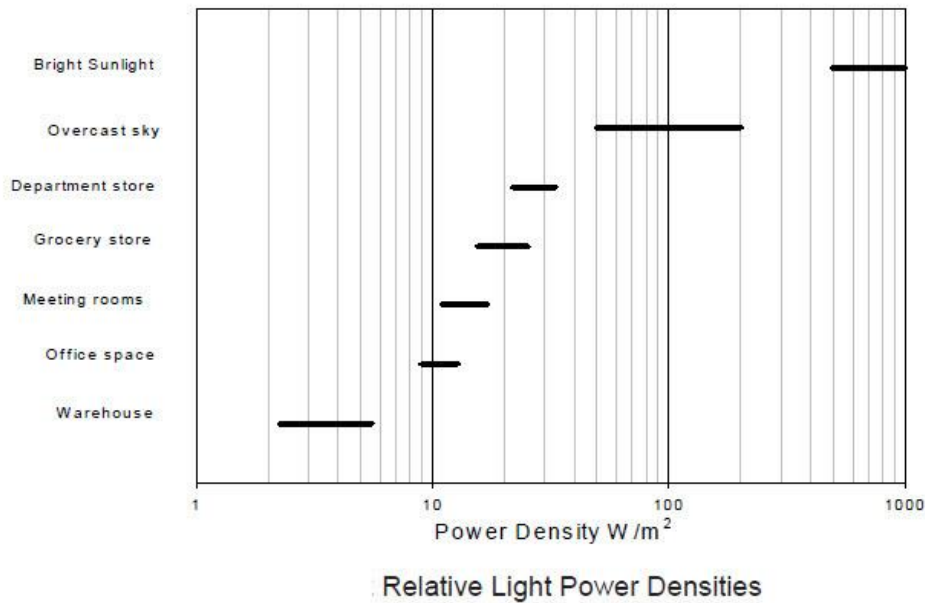

Relative Lighting Power Density

The figure above compares relative power density for various lighting conditions in units of Watts per square meter (W/m^2). The reference standard condition is 1 Sun and is equal to 1000 Watts per square meter of sunlight irradiance at a constant 25°C cell temperature and at 1.5 Air Mass (Air Mass stands for a well defined light spectrum which appears if the sunlight goes through the earth's atmosphere at a defined angle).

As the chart clearly shows, the power density of typical indoor lighting is dramatically lower than that of sunlight. Not only is irradiance from indirect and artificial light lower; the spectrum is also narrower. In typical Office Space lighting with a spectrum produced from incandescent or halogen light bulbs, the power output may be roughly 100 times less than bright sunlight. It may be 200 to 500 times less with fluorescent lighting due to the further limited spectrum.

ANYSOLAR makes no representations or warranties with respect to the accuracy or completeness of the contents of this publication and reserves the right to make changes to specifications and product descriptions at any time without notice. Neither circuit patent licenses or indemnity are expressed or implied. Except as set forth in ANYSOLAR Standard Terms and Conditions of Sale, ANYSOLAR assumes no liability whatsoever, and disclaims any express or implied warranty relating to its products, including, but not limited to, the implied warranty of merchantability, fitness for a particular purpose, or infringement of any intellectual property right. The products described in this document are not designed, intended, authorized, or warranted for use as components in systems intended for surgical implant into the body, or in other applications intended to support or sustain life, or where malfunction of ANYSOLAR product may result in direct physical harm, injury, or death to a person or severe property or environmental damage. ANYSOLAR reserves the right to discontinue or make changes to its products at any time without notice.