

S285-05 Coolant Level Switch

Document ref.: DDS_S285-05

25-Jan-21

Rev. 1

The S285 capacitance type coolant level switch is an active device designed to give an alarm signal if liquid falls below, or rises above, a preset level.

It can be specified with a delay to eliminate false alarms due to turbulence. Containing a factory programmable microprocessor, the switch offers sink to ground or source voltage output.

The switch is designed to operate in both earthed metal and isolated plastic tanks. For high accuracy the S285 is ideally mounted horizontally at the point where an alarm or control signal is required.

Part	S285-05
Description	1/2" NPTF, PU 1 LIQ, SI 10 FA, SI AIR,
Prod. Group	Coolant Level Switch
Technology	Capacitance
Liquid	Water based Coolant
Output Type	Sink (Open collector)
Connector	Metri-pack 150 - 4 Pins
Thread	1/2" NPTF

Performance

Output	Sink in Air
Alarm Delay	10 s (Factory Set)
Power Up	in Liquid
Switch Sense	Level Falling

Materials

Body	Brass
Probe	PTFE
Terminals	Brass, Tin Plated
Seals	EDPM, FVMQ
Connector	30% Glass Filled Nylon
Thread Seal	Vibra-Seal 516

Ratings

Sealing	IP67
Pressure	5 Bar (max)
Drop	1M to concrete
Vibration	15.3 Grms
Temperature	-40 to +125 C
EMC	ISO13766:2006

Electricals

Supply Voltage	9-36 VDC
Supply Current	7 mA + source output

Harness Information

Connector	M/P 150-4P
Source Output	Pin A
Sink Output	Pin D
+ve supply location	Pin C
Ground	Pin B

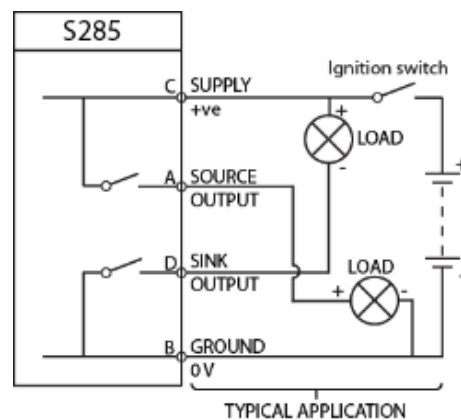
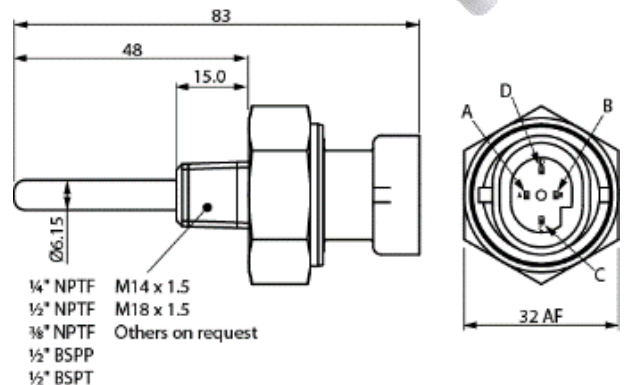

NOTE: IF SINK ONLY OUTPUT IS REQUIRED THEN PIN A IS NOT USED.