

DATASHEET

Integra

SR4L049-L • lamiiANT[®]
SR4L049-R • lamiiANT[®]



Features

- Antenna for 3G and 4G applications
- LTE, GSM, CDMA, DCS, PCS, WCDMA, UMTS, HSPDA, GPRS, EDGE, IMT
- Corner placement with Left and Right variants
- Surface Mounted Device (SMD) with omnidirectional radiation pattern
- Supplied on Tape and Reel for automated manufacturing
- Automotive temperature rating
- Ultra-compact 23 x 8 x 3.3mm
- Suited for high data-rates using MIMO antennas

Contents

1.	Description	2
2.	Applications	2
3.	General data	2
4.	Part number	3
5.	RF characteristics	3
6.	RF performance	4
6.1.	Return loss	4
6.2.	VSWR	4
6.3.	Efficiency	5
6.4.	Antenna pattern	6
6.5.	Optimising antenna efficiency	10
7.	Antenna dimensions	11
8.	Schematic symbol and pin definition	12
9.	Host PCB footprint	12
10.	Electrical interface	13
10.1.	Transmission line	13
10.2.	Matching circuit	13
11.	Antenna integration guide	14
11.1.	Antenna placement	14
11.2.	Host PCB layout	15
11.3.	Host PCB clearance	15
11.4.	Diversity	15
12.	Reference board	16
12.1.	Reference board matching circuit	16
13.	Soldering	17
14.	Hazardous material regulation conformance	17
15.	Packaging	17
15.1.	Optimal storage conditions	17
15.2.	Tape characteristics	18
15.3.	Reel dimensions	19
15.4.	Box dimensions	19
15.5.	Bag properties	20
15.6.	Reel label information	20

1. Description

The high-performance of the Integra antenna assists with passing PTCRB certification and other wireless standards. The antenna has been designed into both MIMO and single antenna systems. The corner placement of the antenna on the host PCB minimizes space requirements and gives consistent radiation patterns. This product specification shows the antenna performance across all frequency bands.

2. Applications

- MIMO and single antenna systems
- Pico base-stations
- 4G Mi-Fi Routers
- Medical equipment
- CCTV (Closed Circuit TV) over cellular
- Communications for Drones
- OBD2 and automotive systems
- Remote monitoring

3. General data

FREQUENCY	791-960MHz 1710-2170MHz 2300-2400MHz 2500-2690MHz
POLARIZATION	Linear
OPERATING TEMPERATURE	-40°C to 140°C
ENVIRONMENTAL CONDITION TEST	ISO16750-4 5.1.1.1/5.1.2.1/5.3.2
IMPEDANCE WITH MATCHING	50 Ω
WEIGHT	<2.5g
ANTENNA TYPE	SMD
DIMENSIONS	23.0 x 8.0 x 3.3 (mm)

4. Part number

INTEGRA LEFT
SR4L049-L

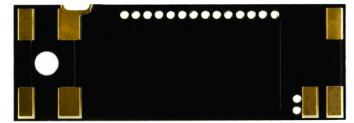

INTEGRA RIGHT
SR4L049-R



5. RF characteristics

	791-960MHZ	1710-2170MHZ
PEAK GAIN	1.9dBi	3.0dBi
AVERAGE GAIN (LINEAR)	-1.5dBi	-2.0dBi
AVERAGE EFFICIENCY	>70%	>60%
MAXIMUM RETURN LOSS	-7.8dB	-5.0dB
MAXIMUM VSWR	2.3:1	3.6:1

	2300-2400MHZ	2500-2690MHZ
PEAK GAIN	3.3dBi	3.5dBi
AVERAGE GAIN (LINEAR)	-2.0dBi	-2.60dBi
AVERAGE EFFICIENCY	>60%	>50%
MAXIMUM RETURN LOSS	-9.7dB	-4.5dB
MAXIMUM VSWR	1.9:1	4.1:1

All data measured on Antenna's evaluation PCB Part
No. SR4L049-EVB-1

6. RF performance

6.1. Return loss

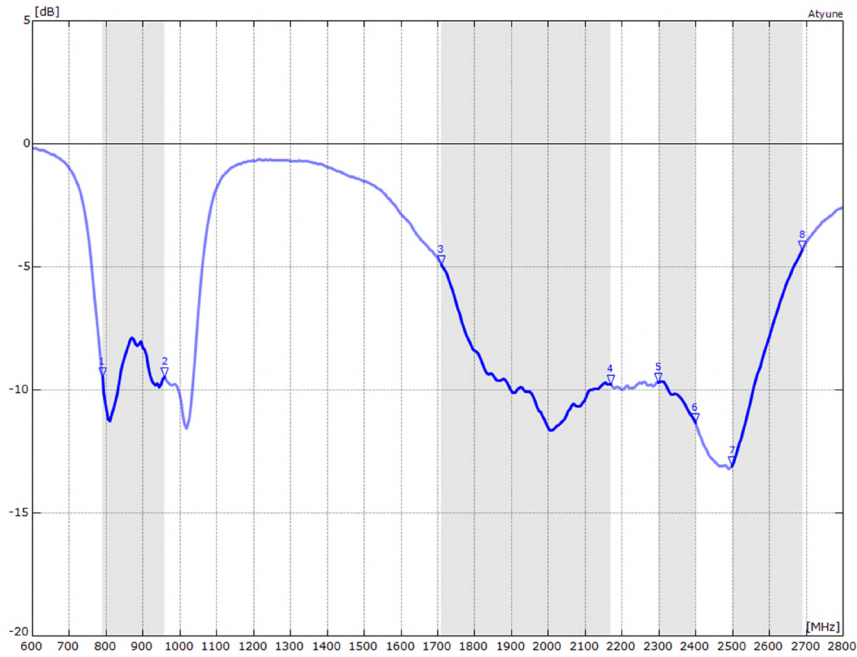

6.2. VSWR

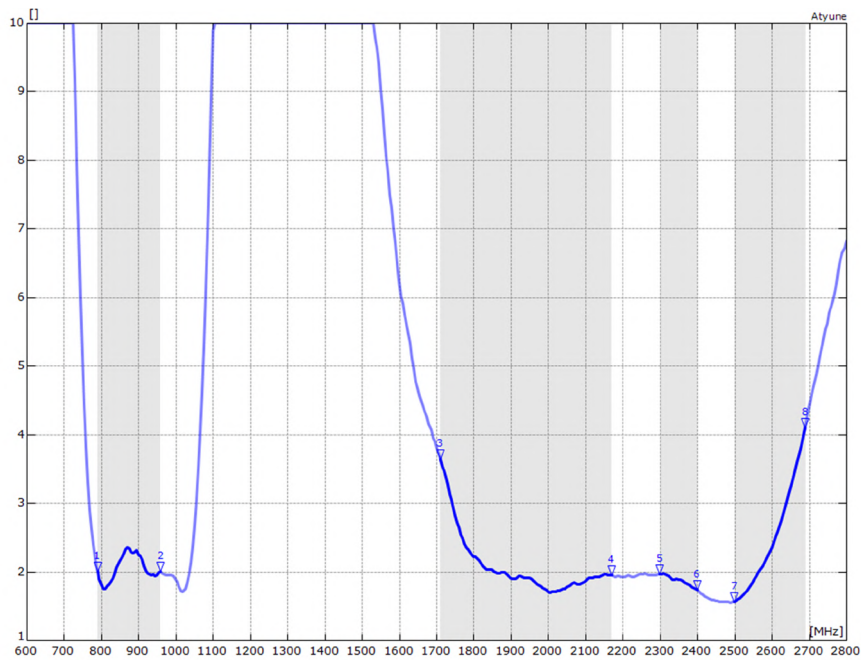

6.3. Efficiency

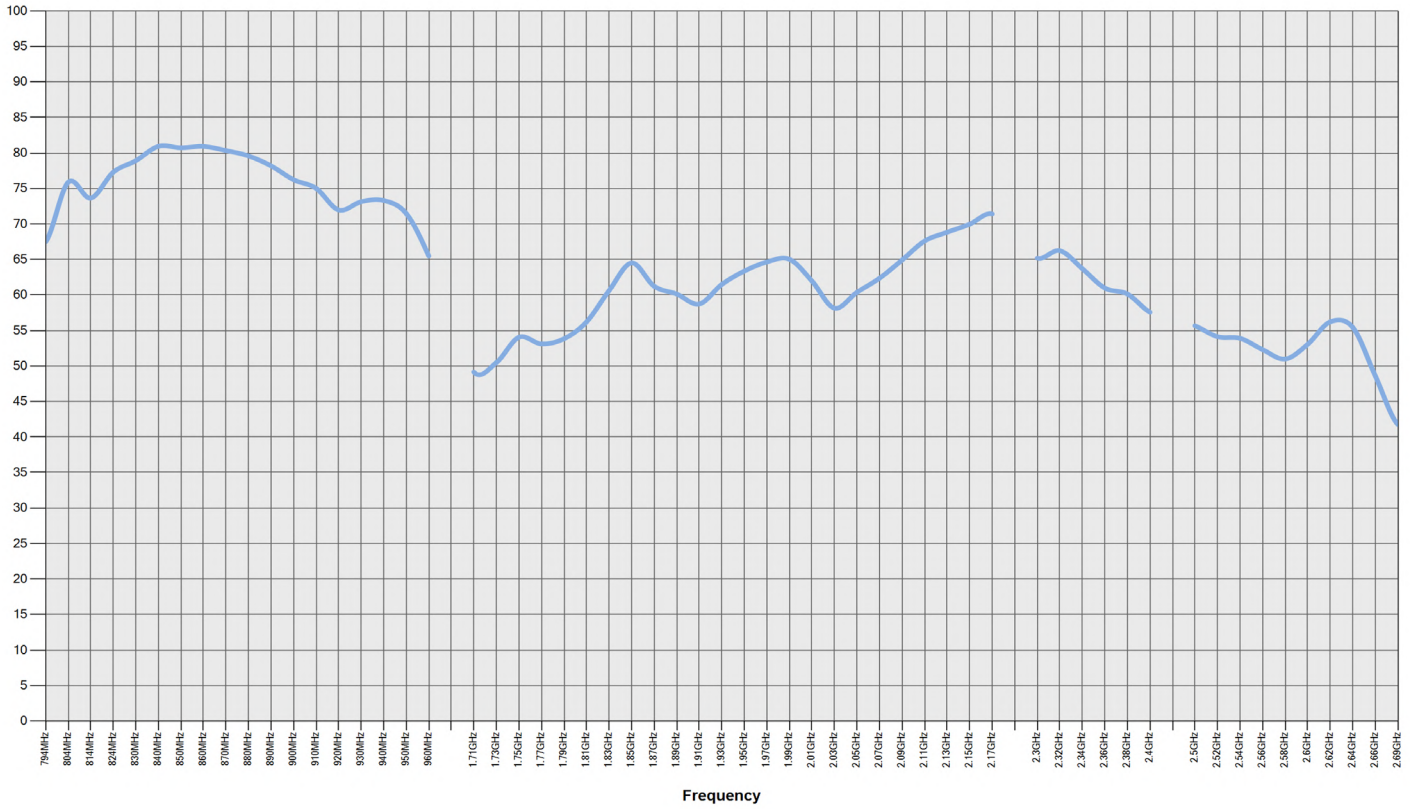

6.4. Antenna pattern

6.4.1. 791 MHz – 960 MHz

3D pattern at 880MHz

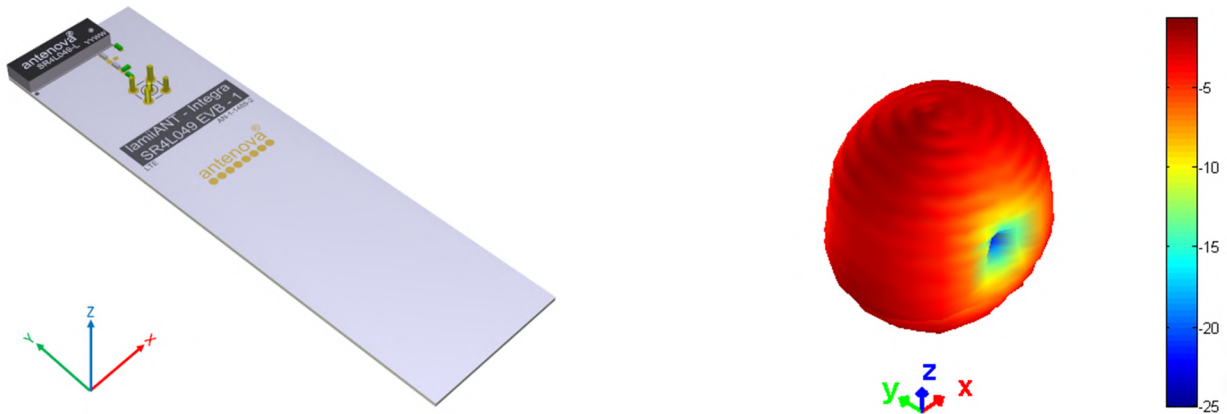

XY

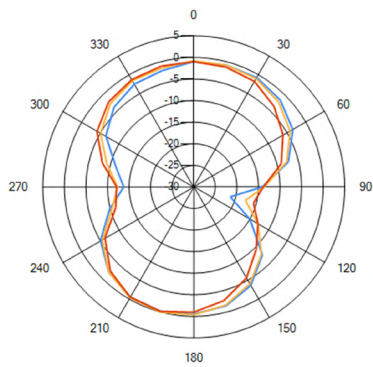

XZ

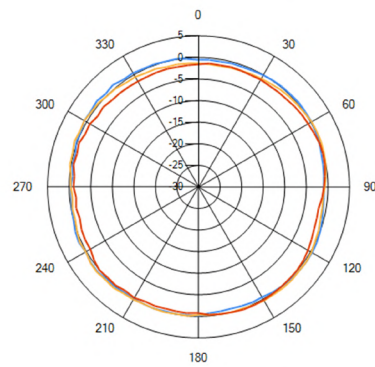

YZ

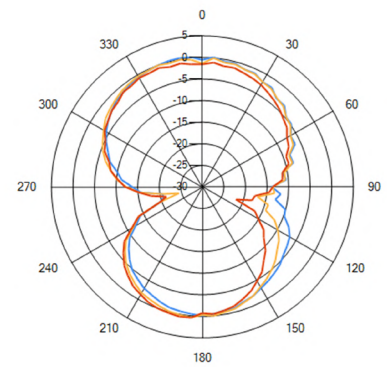

— 794MHz — 880MHz — 960MHz

6.4.2. 1710 MHz – 2170 MHz

3D pattern at 1990MHz

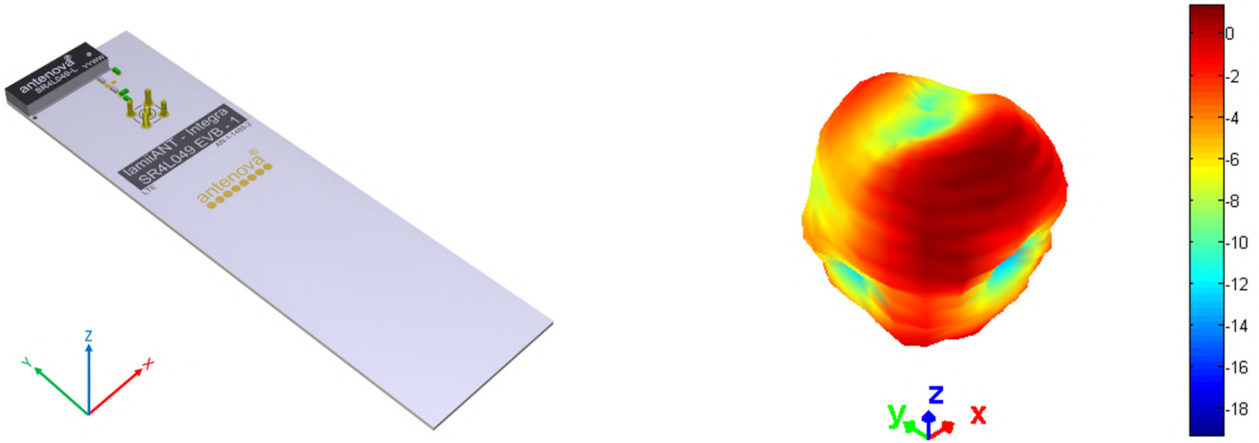

XY

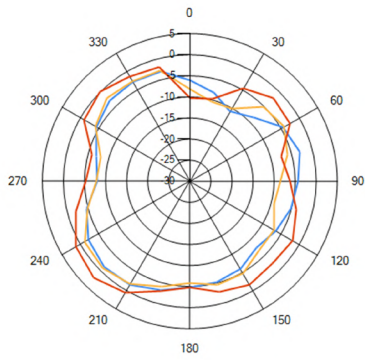

XZ

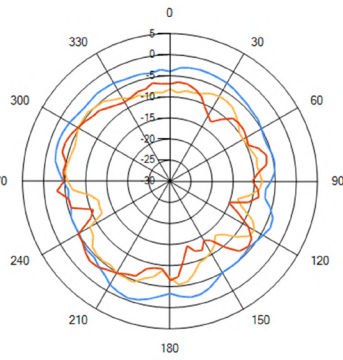

YZ

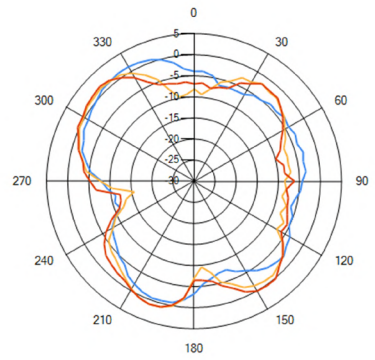

— 1.71GHz — 1.99GHz — 2.17GHz

6.4.3. 2300 MHz – 2400 MHz

3D pattern at 2350MHz

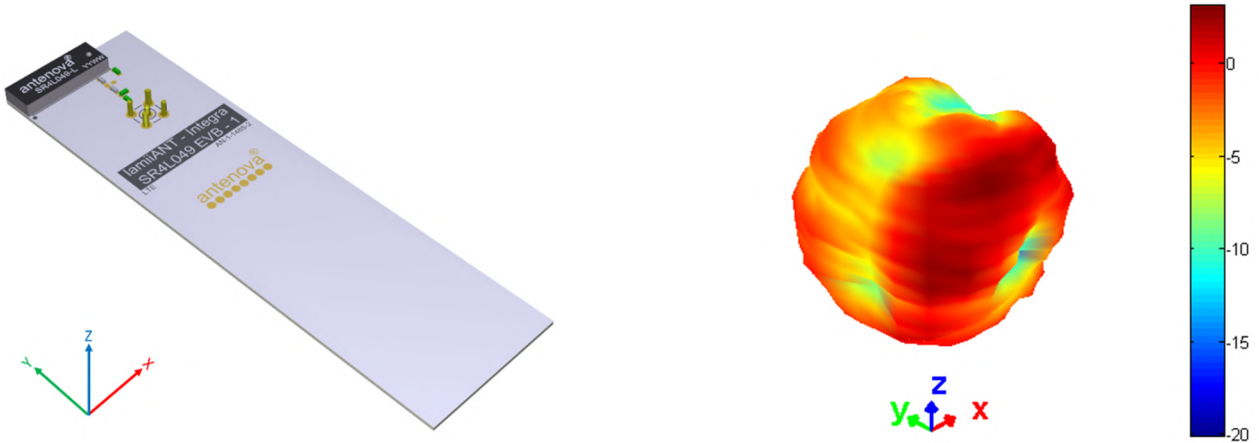

XY

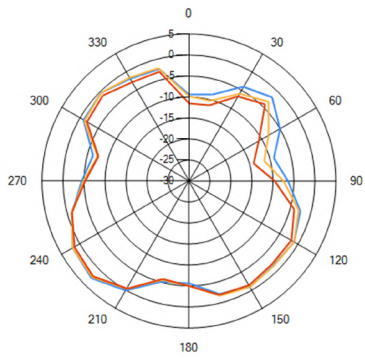

XZ

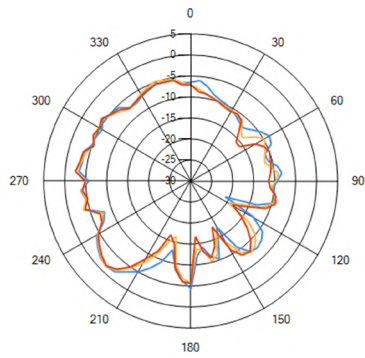

YZ

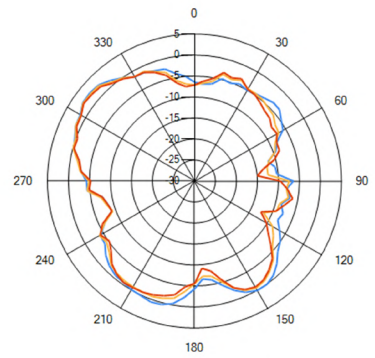

— 2.3GHz — 2.36GHz — 2.4GHz

6.4.4. 2500 MHz – 2690 MHz

3D pattern at 2600MHz

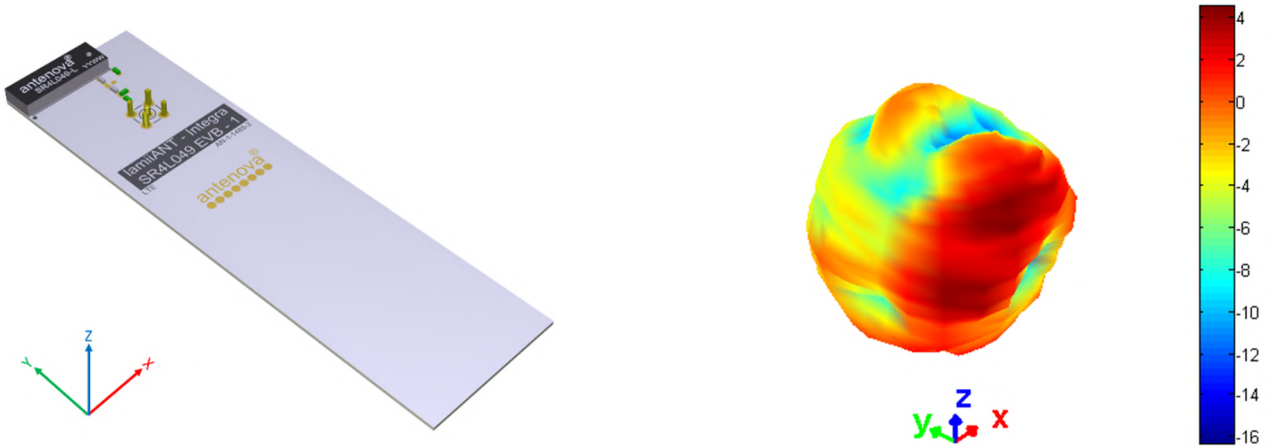

XY

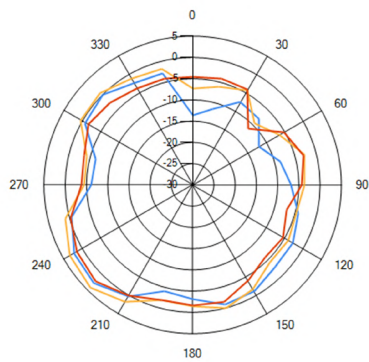

XZ

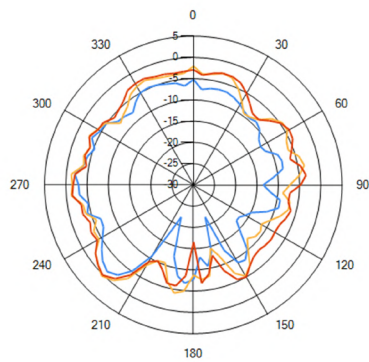

YZ

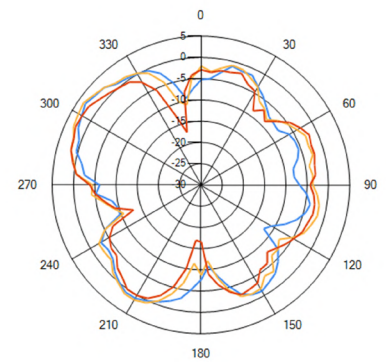

— 2.5GHz — 2.6GHz — 2.69GHz

6.5. Optimising antenna efficiency

All SMD cellular antennas require a ground plane on the host PCB for best radiation efficiency, especially in the sub-GHz bands. On an ideal PCB the antenna needs the ground plane length to be greater than a quarter wavelength of the lowest frequency used. If the ground plane is less than this, the efficiency will be reduced. E.g. to calculate the wavelength of 791MHz:

$$\lambda = \frac{c}{f} = \frac{3 \times 10^8}{791 \times 10^6} = 379 \text{mm}$$

$$\frac{1}{4} \lambda = 95 \text{mm}$$

In practise, the optimum PCB length will be slightly greater than $\frac{1}{4}$ wavelength + antenna + clearance area, for Integra that optimum PCB length is 125mm.

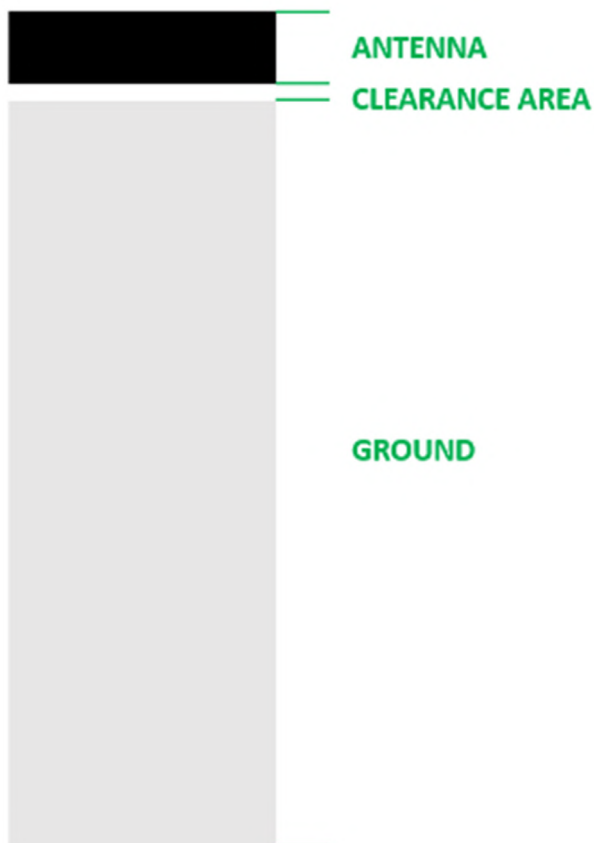

7. Antenna dimensions

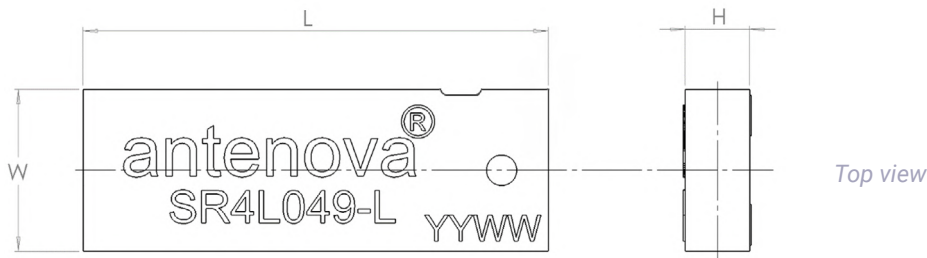

Top view

L	W	H
Length	Width	Height
23.0 ±0.1	8.0 ±0.1	3.3 ±0.1

All dimensions in (mm)
 -L and -R Dimensions are the same

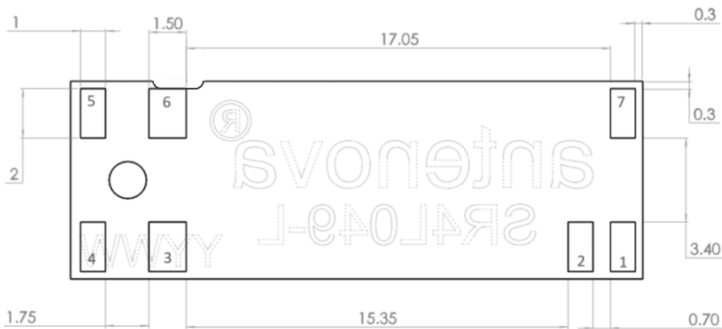

Bottom view

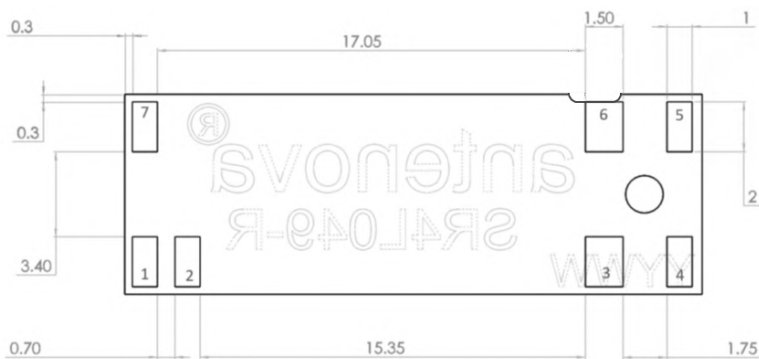

Bottom view

8. Schematic symbol and pin definition

The circuit symbol for the antenna is shown below. The antenna has 7 pins with only 4 as functional. All other pins are for mechanical strength.

PIN	DESCRIPTION
3	Feed (Transceiver port)
4	T1 (Return/Tuning)
5, 6, 7	NC (Not used, mechanical only)
1, 2	SC (Pins 1 and 2 short circuit on host PCB)

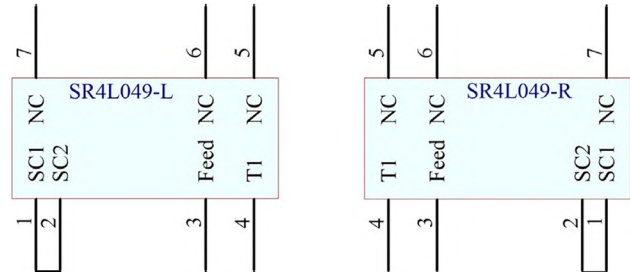

9. Host PCB footprint

The recommended host PCB footprint is below.

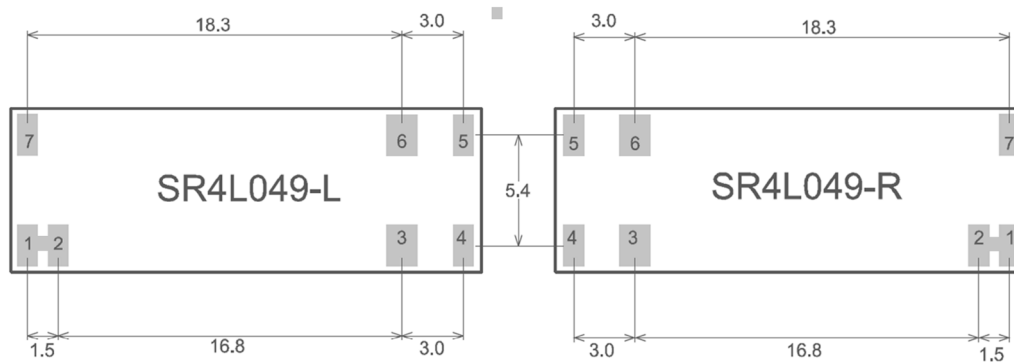

Pads 1, 2, 4, 5, 7 = 2.0 x 1.0 (mm)

Pads 3, 6 = 2.0 x 1.5 (mm)

10. Electrical interface

10.1. Transmission line

All transmission lines should be designed to have a characteristic impedance of 50Ω.

- The length of each transmission line should be kept to a minimum
- All other parts of the RF system like transceivers, power amplifiers, etc, should also be designed to have a 50 Ω impedance

A co-planar transmission line can be designed using an online transmission line calculator tool, such as:

<https://blog.antenova.com/rf-transmission-line-calculator>

The PCB thickness, copper thickness and substrate dielectric constant are entered, then the tool calculates the transmission line width and gaps on either side of the track to give a 50 Ω impedance.

10.2. Matching circuit

The antenna requires a matching circuit that must be optimized for each product. The matching circuit will require up to six components and the following circuit should be designed into the host PCB. Not all components may be required but should be included as a precaution. The matching network should be placed close to the antenna feed to ensure it is optionally effective in tuning the antenna.

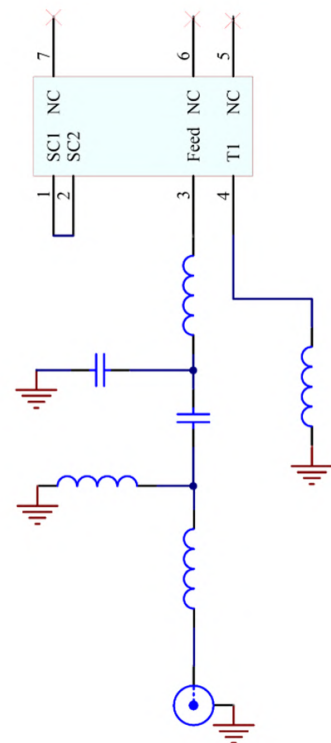

11. Antenna integration guide

We recommend the following during the design phase to maximise antenna performance and minimize noise:

- Minimum 4 layer PCB
- Route signals and power internally where possible
- Flood all layers with ground
- Knit ground on all layers together with plenty of vias

Follow placement guidance carefully, in addition Antenova provide technical support to help you through all stages of your design. Register for an account on <https://ask.antenova.com/> to access technical support.

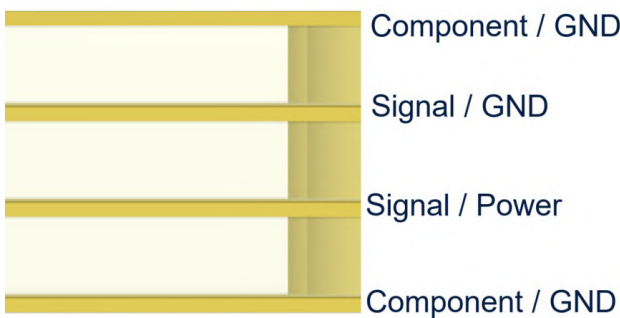

11.1. Antenna placement

The best position for the antenna is in the corner of the short side of the PCB. This allows the longer side of the PCB to be a ground plane, a long ground plane improves the antenna’s efficiency. The Antenova placement tool can be used to advise on antenna placement, see:

<https://blog.antenova.com/intelligent-antenna-selection-and-placement-tool-antenova>

Horizontal placement

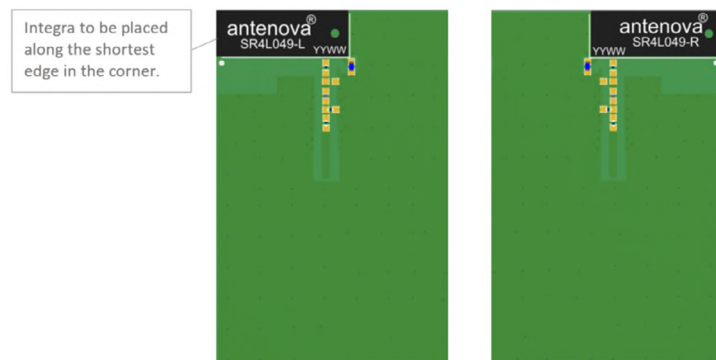

Vertical placement

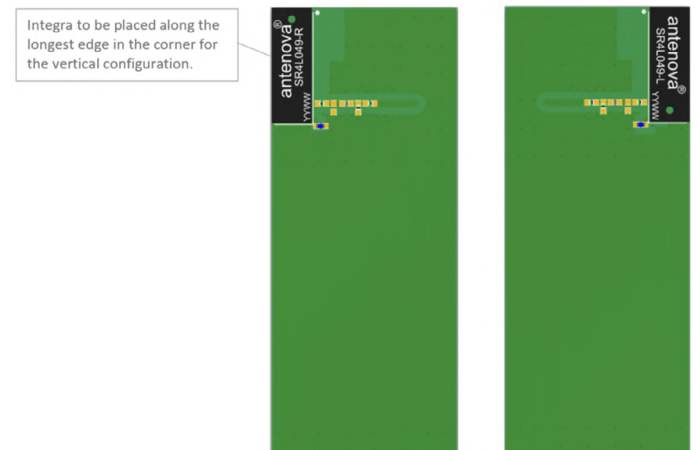

Vertical placement optimal minimum GND length required is $\geq 100\text{mm}$

11.2. Host PCB layout

The host PCB must be designed using the PCB footprint shown with the correct clearances. An example of the PCB layout shows the antenna footprint. Please note this clearance area is critical to the performance of the antenna and must be applied through all layers of the PCB.

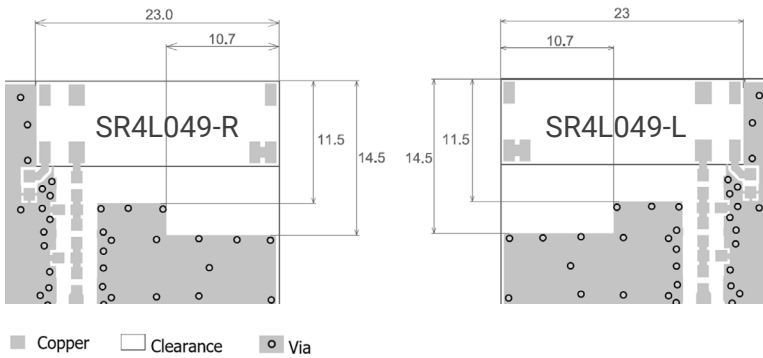

All dimensions in (mm)

11.3. Host PCB clearance

The diagram below shows the antenna footprint and clearance through all layers on the PCB. Only the antenna pads and connections to feed and GND are present within this clearance area.

Placement of components and GND with traces adjacent to the antenna should maintain a minimum clearance of 15mm from either side. The antenna should therefore be placed in the corner to only have one side affected.

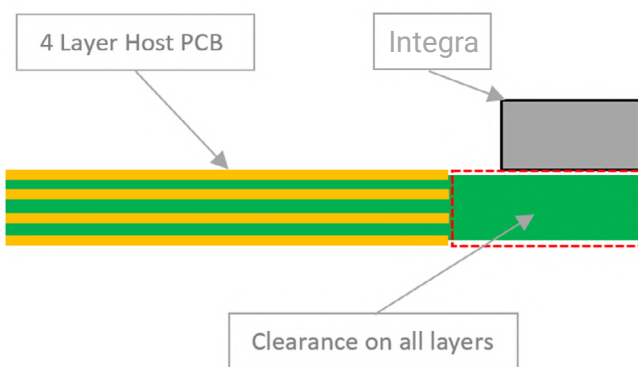

11.4. Diversity

The Integra antenna is suitable for use in diversity antennas. To implement a diversity antenna, follow the guidance given in the Diversity Antennas app note. This can be downloaded from Antenova.com.

12. Reference board

A reference board is used for evaluating the antenna SR4L049-L and it includes a SMA female connector. (Part number: SR4L049-EVB-1)

To order a reference board please see antenna.com



12.1. Reference board matching circuit

DESIGNATOR	TYPE	VALUE	DESCRIPTION
L1	Inductor	4.7nH	Murata LQG15HN series
L2, C2	NA	DNP	Not Fitted
C1	Capacitor	1.2pF	Murata GJM15 series
L3	Inductor	2.2nH	Murata LQG15HN series
L4	Inductor	3.3nH	Murata LQG15HN series

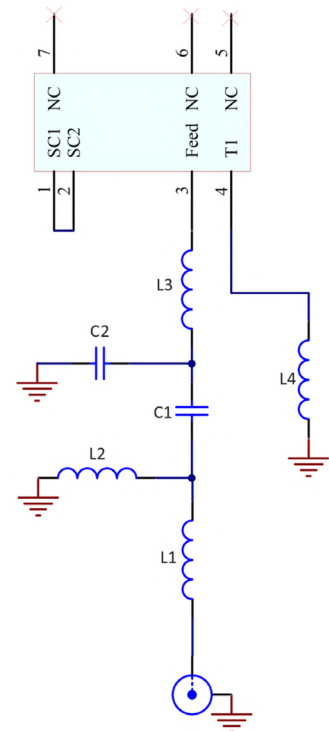

13. Soldering

This antenna is suitable for lead free soldering. The reflow profile should be adjusted to suit the device, oven and solder paste, while observing the following conditions:

- For leaded soldering, the maximum temperature should not exceed 240 °C.
- For lead free soldering, a maximum temperature of 255 °C for no more than 20 seconds is permitted.
- The antenna should not be exposed to temperatures exceeding 120 °C more than 3 times during the soldering process.

14. Hazardous material regulation conformance

The antenna has been tested to conform to RoHS and REACH requirements. A certificate of conformance is available from Antenova's website.

15. Packaging

15.1. Optimal storage conditions

TEMPERATURE	-10°C to 40°C
HUMIDITY	Less than 75% RH
SHELF LIFE	24 Months
STORAGE PLACE	Away from corrosive gas and direct sunlight
PACKAGING	Reels should be stored in unopened sealed manufacturer's plastic packaging.
MSL LEVEL	1

Note: Storage of open reels of antennas is not recommended due to possible oxidization of pads on antennas. If short term storage is necessary, then it is highly recommended that the bag containing the antenna reel is re-sealed and stored in conditions as described in the table above.

The shelf life of the antenna is 2 years provided the factory seal on the package has not been broken.

15.2. Tape characteristics

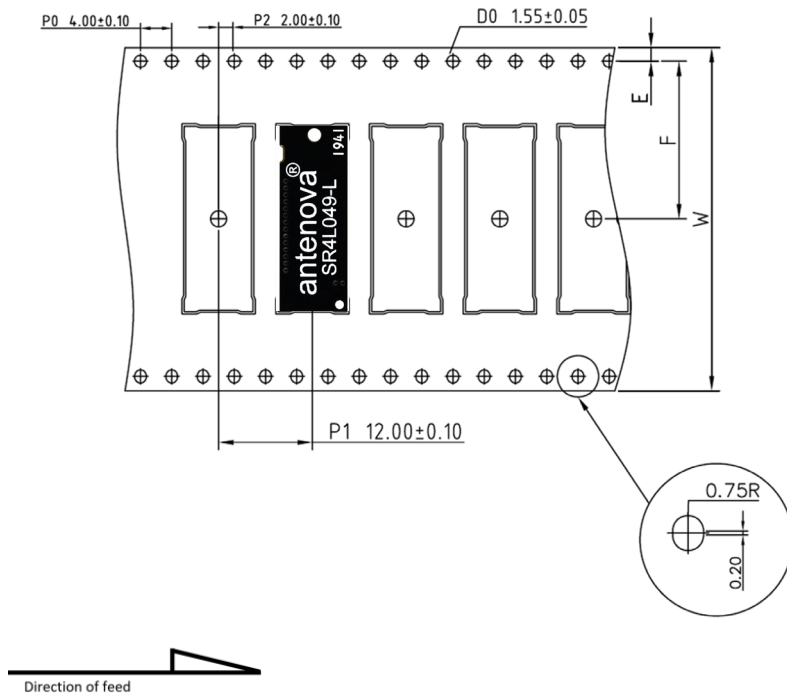

P0	P1	P2	D0
4.00 ± 0.1	12.00 ± 0.1	2.00 ± 0.1	1.55 ± 0.1

E	F	W
1.75 ± 0.1	20.20 ± 0.15	44.00 ± 0.3

All dimensions in (mm)

QUANTITY	LEADING SPACE	TRAILING SPACE
1000 pcs / reel	30 blank antenna holders	30 blank antenna holders

15.3. Reel dimensions

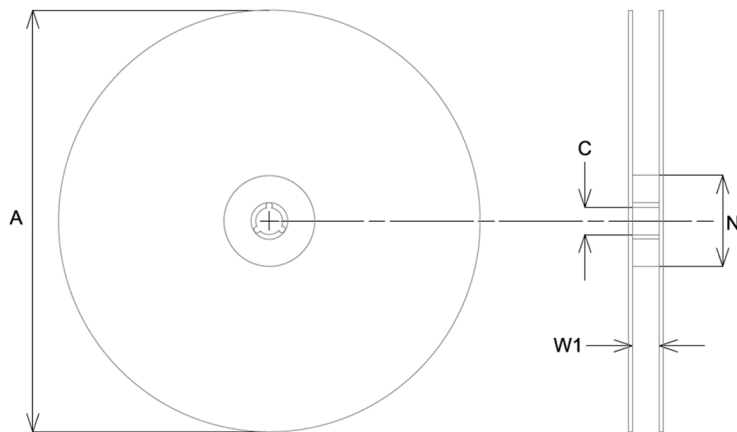

A	C	N	W1
330.0 ± 2.0	13.0 ± 0.5	80.0 ± 0.2	44 ± 0.3

All dimensions in (mm)

15.4. Box dimensions

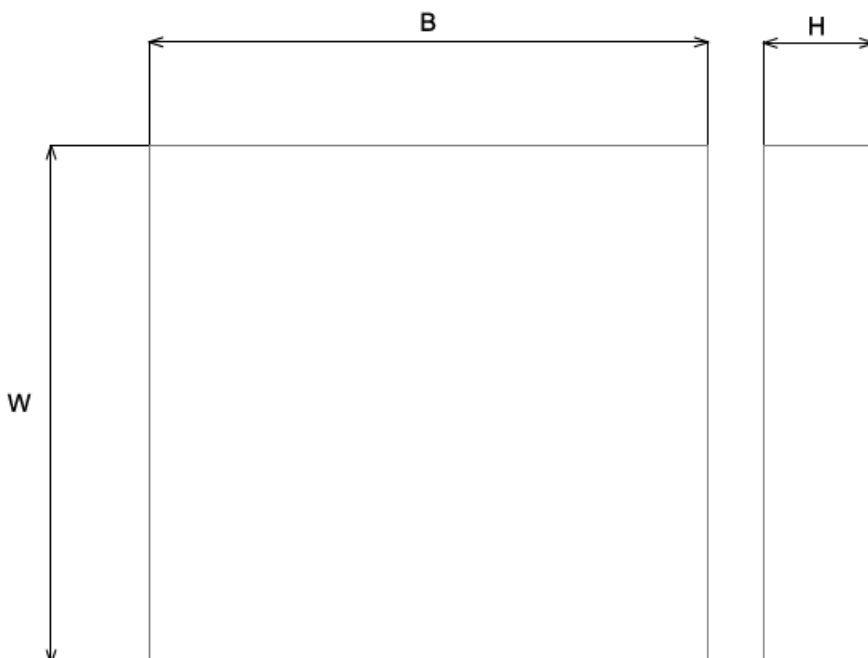

WIDTH (W)	BREADTH (B)	HEIGHT (H)
350mm	340mm	65mm

15.5. Bag properties

Reels are supplied in protective plastic packaging.

15.6. Reel label information



Quality statements

Antenova’s products conform to REACH and RoHS legislation. For our statements regarding these and other quality standards, please see antenova.com.



Antenova reserves all rights to the contents of this document. Antenova gives no warranties based solely on the accuracy or completeness of the contents of this document and reserves the right to make changes to the specifications of the products described herein at any time and without notice.

Datasheet version

2.01 released Aug 31st 2021

2.02 released Apr 22th 2022

Antenna design, integration and test resources

Product designers – the details contained in this datasheet will help you to complete your embedded antenna design. Please follow our technical advice carefully to obtain optimum antenna performance.

We aim to support our customers to create high performance wireless products. You will find a wealth of design resources, calculators and case studies to aid your design on our website.

Antenova's design laboratories are equipped with the latest antenna design tools and test chambers. We provide antenna design, test and technical integration services to help you complete your design and obtain the required certifications.

If you cannot find the antenna you require in our product range, please contact us to discuss creating a custom antenna to meet your exact requirements.

Share knowledge with **RF experts** around the world.

ask.antenova is a global forum for designers and engineers working with wireless technology.

[VISIT ASK.ANTENOVA](https://www.ask.antenova.com)

Visit [antenova.com](https://www.antenova.com)

Order antenna samples and evaluation boards, and read our antenna resources

[VISIT ANTENOVA.COM](https://www.antenova.com)

Request a volume quotation for antennas:

sales@antenova.com

Global headquarters

Antenova Ltd, 2nd Floor Titan Court, 3 Bishop Square, Hatfield, AL10 9NA

+44 (0) 1707 927589