

Revision History

Revision	Date	Description
1.0	November 2020	1 st Release

The information herein is for product information purposes. While the contents in this publication have been carefully checked; no responsibility, however, is assumed for inaccuracies. Silicon Craft Technology PLC. reserves the right to make changes to the products contained in this publication to improve design, performance, or reliability.



Contents

RE31 Mini Reader	1
Revision History	2
Contents.....	3
List of Figures	4
List of Tables	5
1. Introduction.....	6
2. Getting Start.....	7
2.1. System and Hardware Requirements	7
2.2. Software Setup.....	7
2.2.1. Serial Communication Configuration	7
2.2.2. Terminal Software (MobaXterm)	7
2.2.3. Downloading and Installing MobaXterm.....	8
2.2.4. Connecting with PC	10
2.3. Hardware Setup.....	11
3. Example Use Case	13
4. Schematic	14
4.1. MCU Module	14
5. Upgrade Firmware.....	15
6. Product and Documentation Support	16
6.1. Notation	16
6.2. Tools and Software	17
6.3. Documentation Support	17
6.4. Contact Information	17
7. Legal Information.....	18
7.1 Disclaimer	18



List of Figures

Figure 2-1 MobaXterm.....	7
Figure 2-2 MobaXterm Website.....	8
Figure 2-3 MobaXterm Download Page.....	8
Figure 2-4 MobaXterm Home Edition Download Page.....	9
Figure 2-5 MobaXterm Installation Window.....	9
Figure 2-6 MobaXterm Create new session.....	10
Figure 2-7 Sessstion setting.....	10
Figure 2-8 Basic Serial Setting.....	11
Figure 2-9 Successfully RE31 Mini Reader connection.....	11
Figure 2-10 Hardware Connection.....	12
Figure 3-1 Example reading tag's UID.....	13
Figure 4-1 STM8L Module Schematic.....	14
Figure 5-1 STM8L MCU Connection via SWIM.....	15
Figure 6-1 Register Definition.....	16



List of Tables

Table 6-1 Styles and Fonts for keywords..... 16



1. Introduction

RE31 is a single chip reader IC for 13.56MHz RFID/contactless standard protocols including ISO14443A/B, ISO15693. The HiRead-R provides a hi-speed SPI controller/host interface with a built-in 64-byte FIFO for smooth data transfer.

Silicon Craft Technology PLC. (SIC) creates this document to describe how to enable RE31 Mini Reader with PC. This mini reader connects to PC via UART connection.



2. Getting Start

Before user can operate RA12 Mini Reader, proper operational environment and the following requirements must be prepared.

2.1. System and Hardware Requirements

- Computer : PC with USB Port
- Operating System : Window XP, Window 7, 8, 10
- Software Requirement : Hyper Terminal, Tera Term, Putty, MobaXterm, etc.
- Others : ISO14443A/B or ISO15693 Card or Tag.

2.2. Software Setup

2.2.1. Serial Communication Configuration

To communicate with the reader, user must establish a serial connection. The setting below is to config the serial session to match the reader communication configuration.

- Serial Port : Select COM Port which match to USB to UART converter
- Baud Rate : 115200 bps
- Data : 8 bits
- Parity bit : None
- Stop bit : 1 bit

2.2.2. Terminal Software (MobaXterm)

To interact with the reader, a terminal software is needed. Generally, any terminal software is compatible. However, we will use MobaXterm as an example terminal software to communicate with the reader in this case.

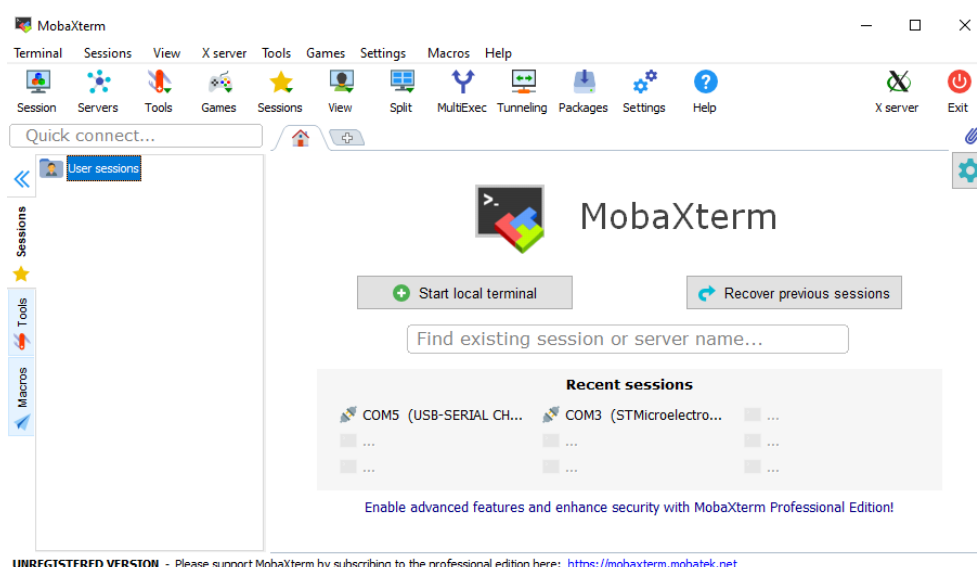

Figure 2-1 MobaXterm



2.2.3. Downloading and Installing MobaXterm

1. To download MobaXterm, please go to this url: <https://mobaxterm.mobatek.net/> then, click the tab "Download" as shown in Figure 2-2.

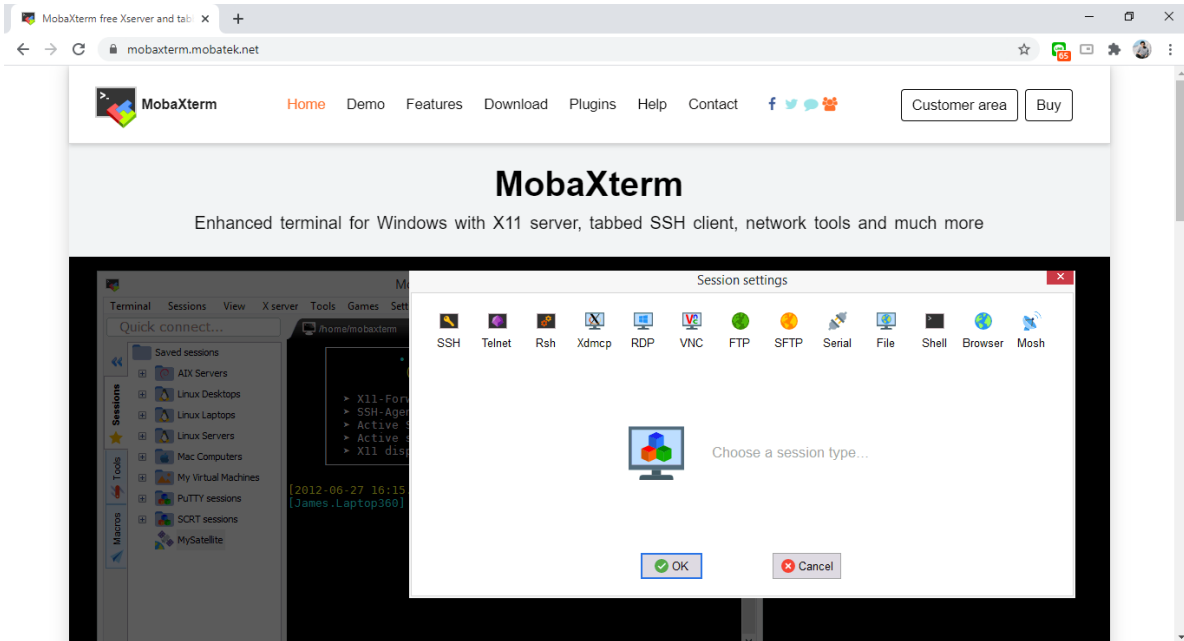

Figure 2-2 MobaXterm Website

2. At download page, click at "Download now" to go to home edition download page as shown in Figure 2-3.

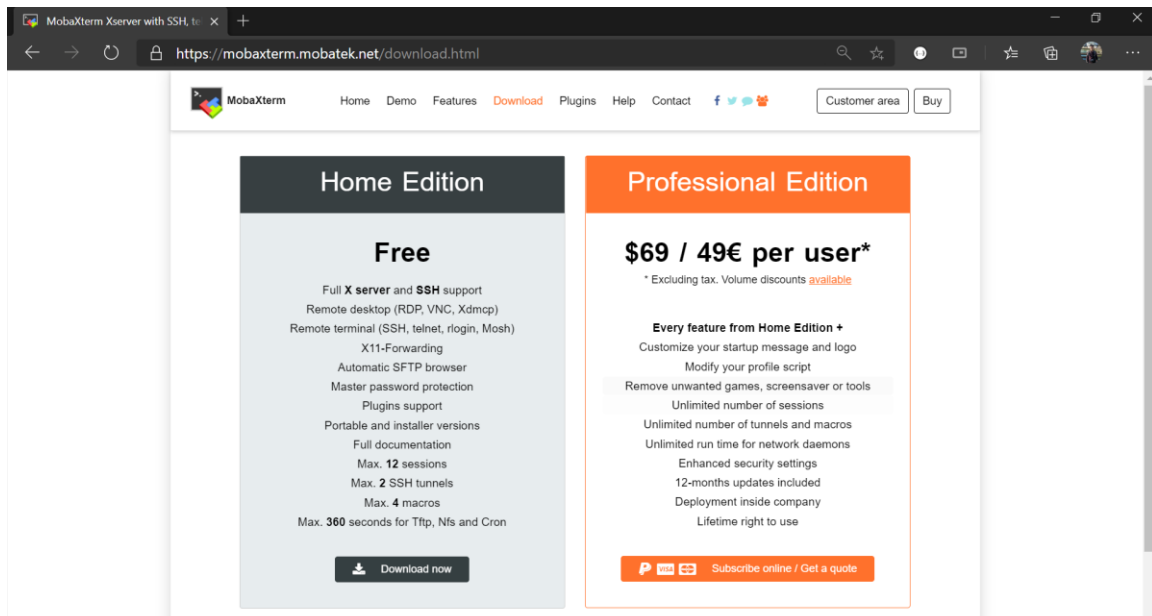

Figure 2-3 MobaXterm Download Page



3. At Home Edition download page, click at "MobaXterm Home Edition v20.2 (Installer Edition)" to download the installer as shown in **Figure 2-4**.

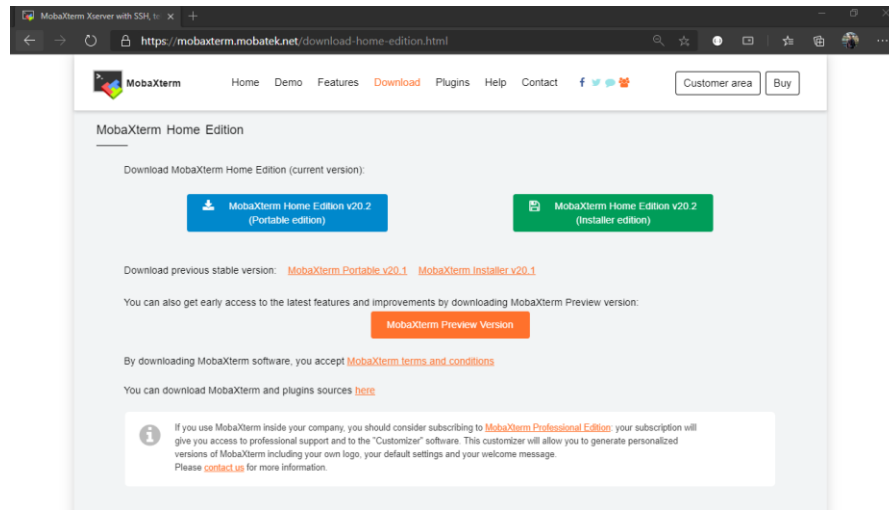

Figure 2-4 MobaXterm Home Edition Download Page

4. When the download is completed, extract the installer.
5. Inside the extracted folder, double click at "MobaXterm_installer_20.2.msi" to begin installation.
6. The installation window will pop up, click "Next" as shown in **Figure 2-5**.

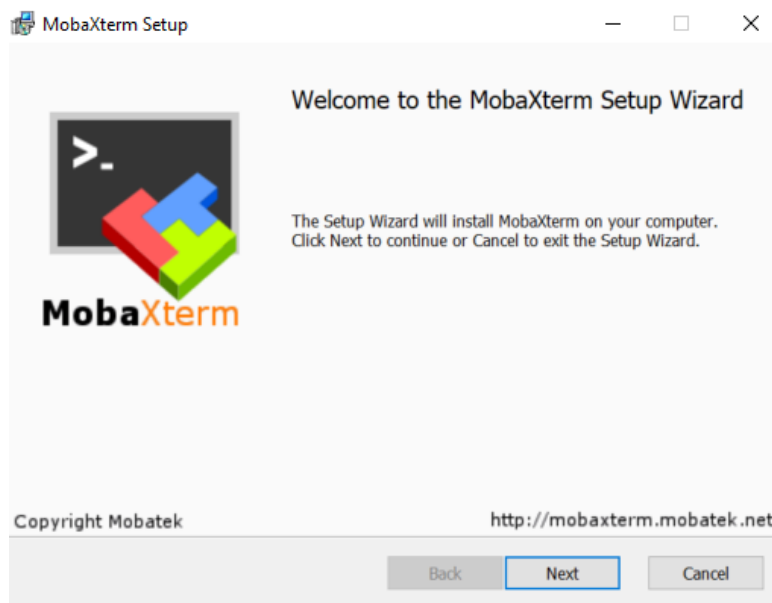

Figure 2-5 MobaXterm Installation Window

7. At End-User License Agreement page, "**check**" the accept box and then click "**Next**".
8. The window will prompt the user to choose the installation folder. Choose your path where you want to install the program then click "**Next**".
9. Click "**Install**" to begin installation.
10. Click "**Finish**" when the installation is completed.



2.2.4. Connecting with PC

In order to communicate with the reader, a serial connection must be initialized. The steps below describe how to properly connect the reader with a PC.

1. Connect the reader to PC using a micro USB cable.
2. Open MobaXterm.
3. On the menu bar at the top left of the program, click at "Session" to create a new session.

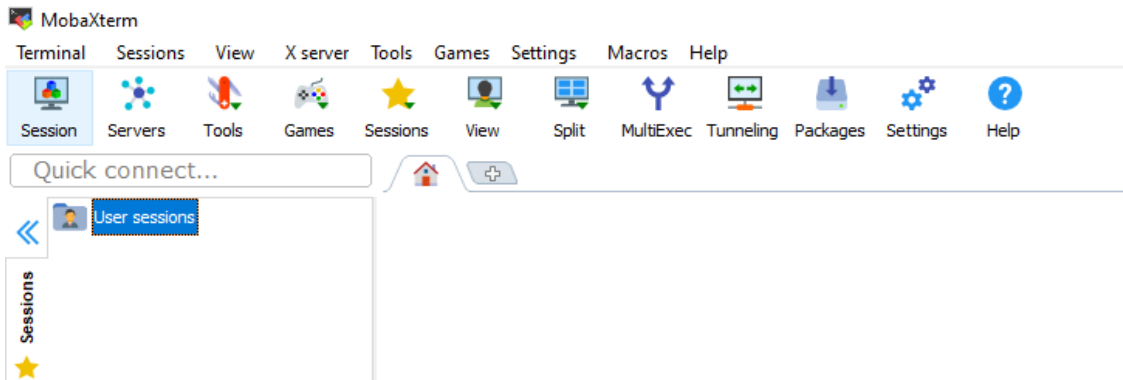

Figure 2-6 MobaXterm Create new session

4. The program will pop up a new window called "Session settings", click on "Serial" to set up a new serial monitor.

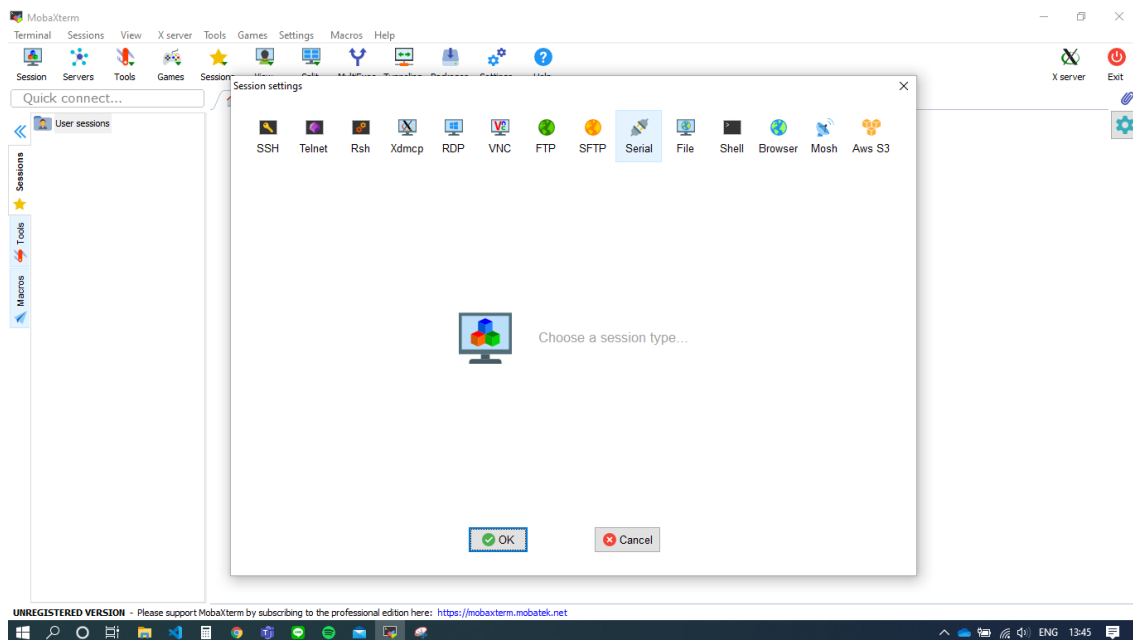

Figure 2-7 Session setting

5. Under the tab "Basic Serial settings", click at the drop-down menu "Serial port" to select a port to connect. If the reader is already connected with the PC then the correspondent port number should be automatically shown up here. Otherwise, try restarting MobaXterm.



Getting Start

- Click at the drop-down menu "Speed (bps)", select "115200" and then click OK to start session.

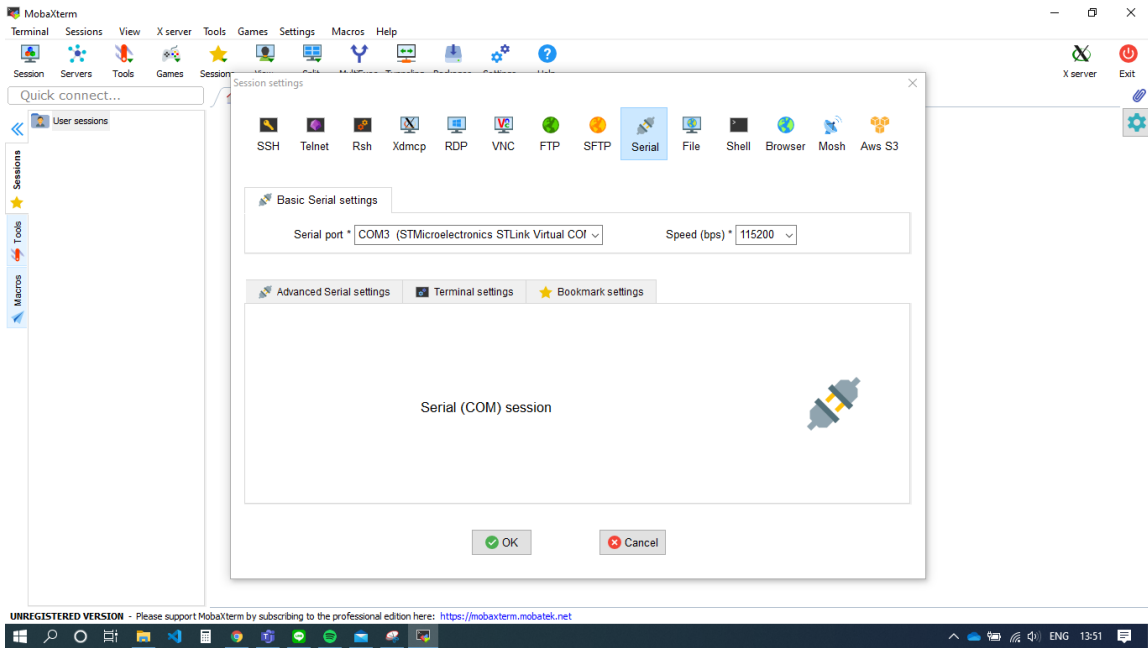

Figure 2-8 Basic Serial Setting

- Consequently, a new session is shown. Press enter to trigger SIC Command Line interface.

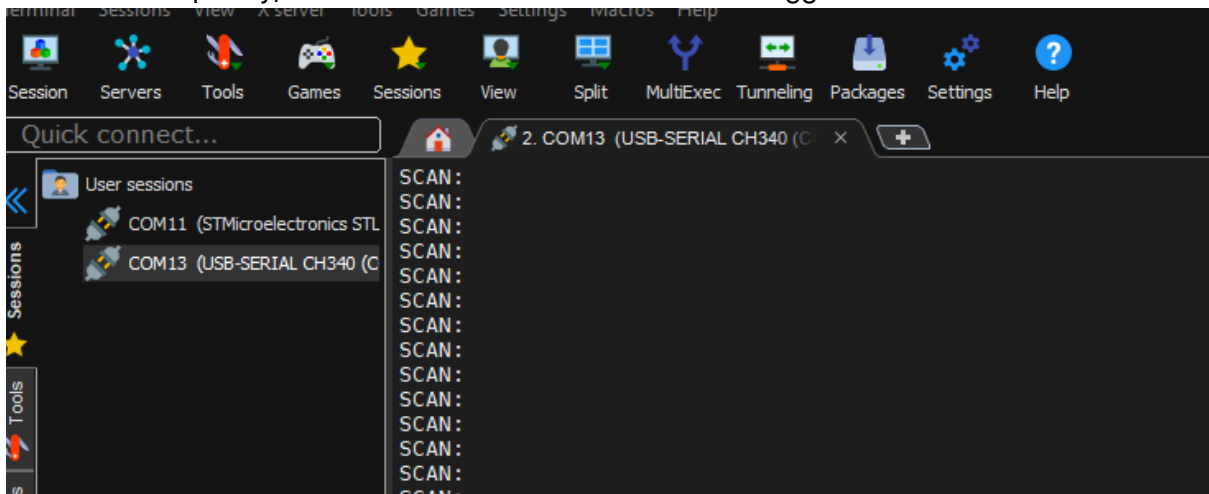

Figure 2-9 Successfully RE31 Mini Reader connection

2.3. Hardware Setup



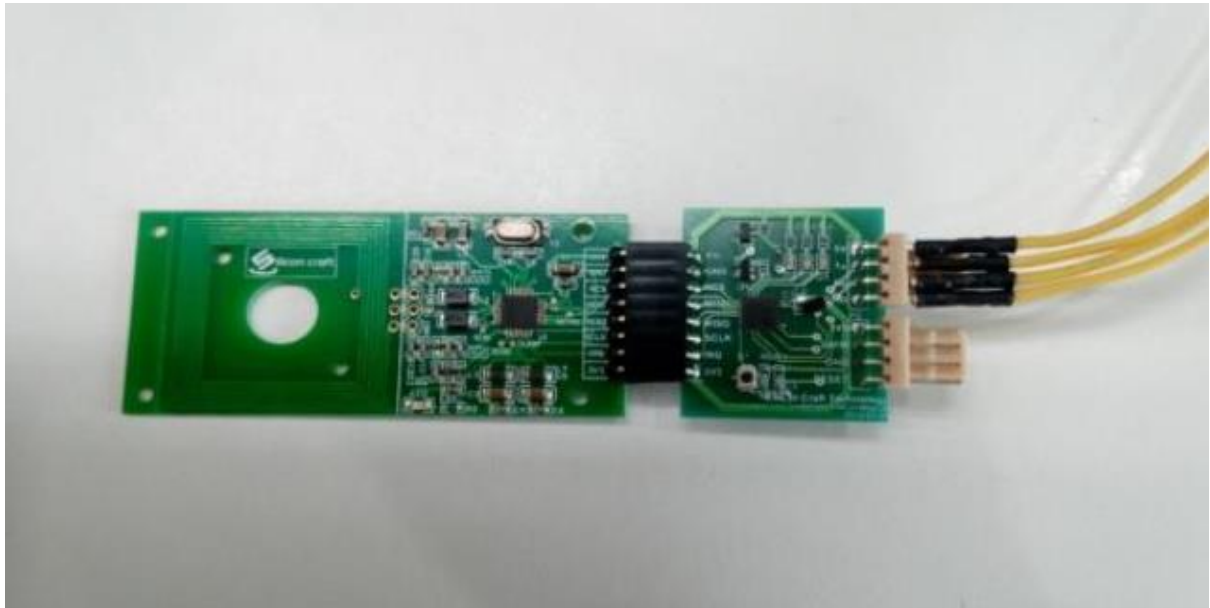

Figure 2-10 Hardware Connection

Refer to **Figure 2-10**, please follow setting below steps:

1. Connects RA12 Mini Reader via UART pin by using USB to UART module and then connect USB to PC.
2. Open software and set up according to section 102.2.4



4. Schematic

4.1. MCU Module

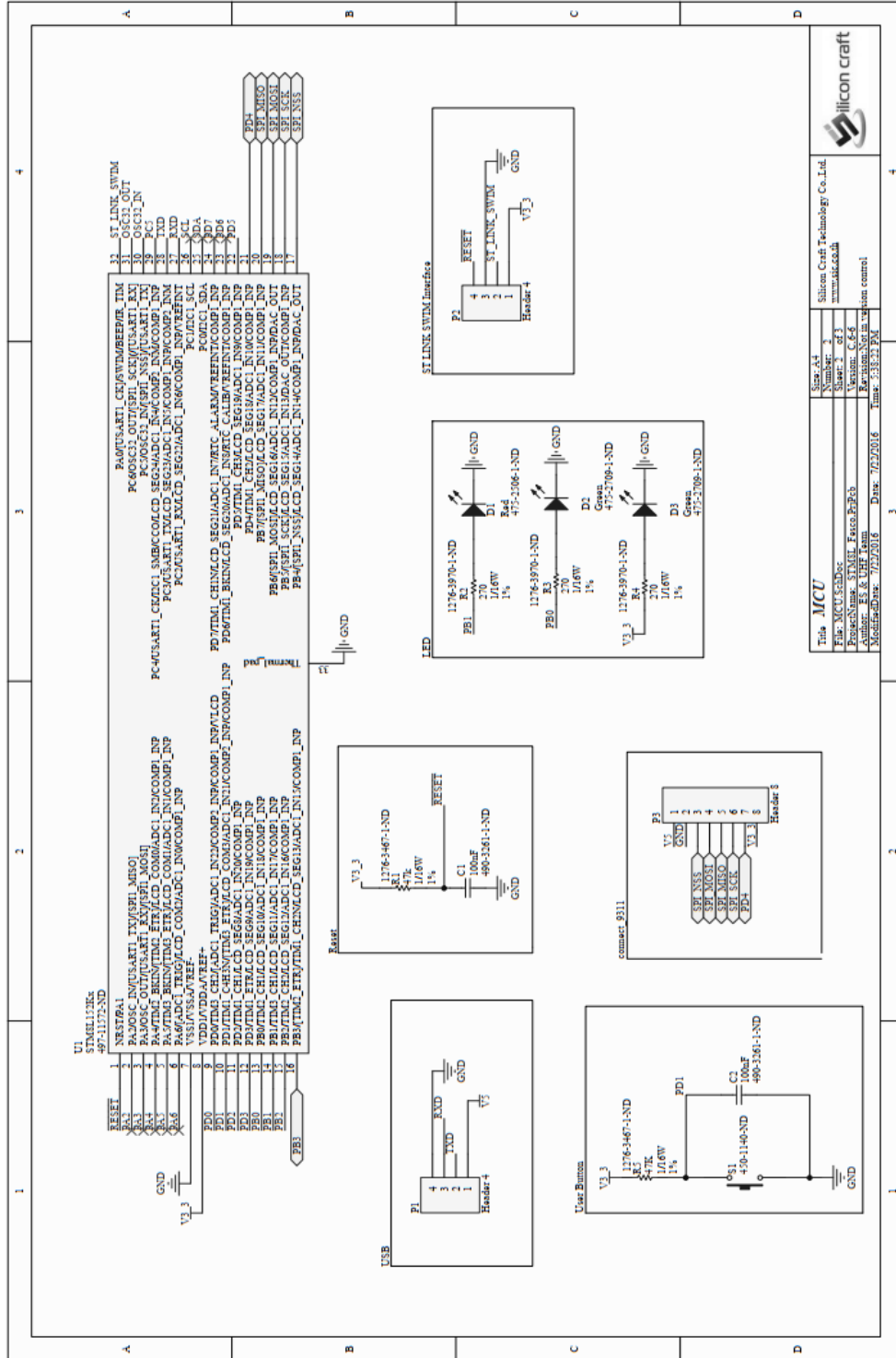

5. Upgrade Firmware

The operation of RE31 Mini Reader is controlled by STM8L MCU. The kit can be programmed or perform firmware update using wire debugging (SWIM). User can use ST-LINK/V2 module with ST Visual Programmer to upgrade firmware.

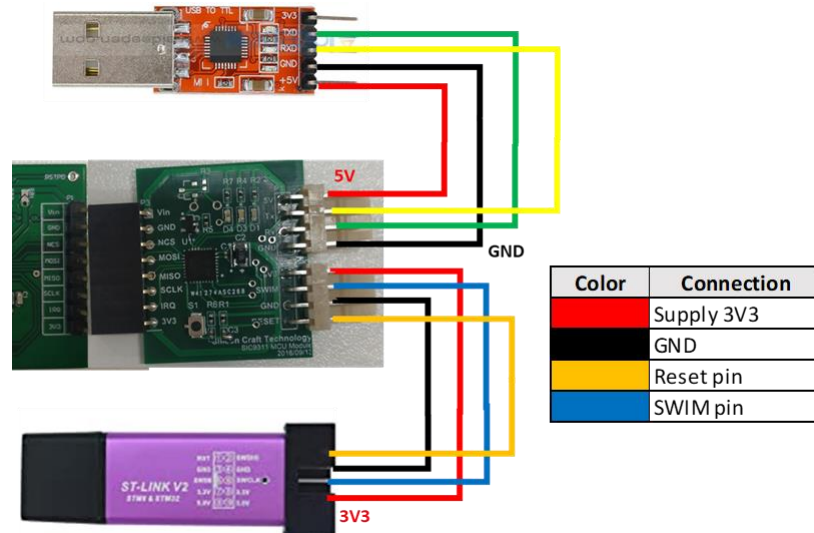

Figure 5-1 STM8L MCU Connection via SWIM



6. Product and Documentation Support

For more information of the SIC products, tools, and support that are available to help your development, please visit www.sic.co.th

6.1. Notation

The register definition is shown in the **Figure 6-1**.

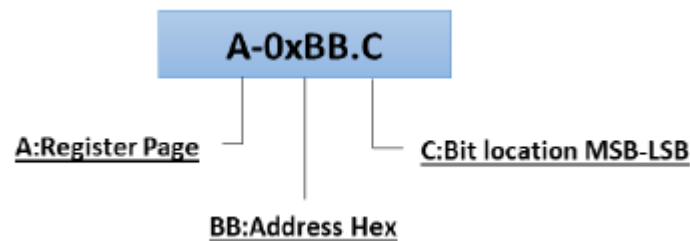

Figure 6-1 Register Definition

Styles and Fonts for key words

This part defines styles and fonts used for the key words throughout this document. The key words are names of signal, register and pin. The styles, fonts and their indications are shown in **Table 6-1**.

Table 6-1 Styles and Fonts for keywords

Symbol	Indication
<i>Signal</i>	Signal name
Register	Register name or Bit name
pin RX	Pin name
<i>"State of Operation"</i>	State of operation
<i>Command</i>	Command name in register 0x01 sector 0

To refer to a register address, a hexadecimal number proceeding with "0x" is used, for example 0x05 refer to a register address 0x05.

To refer to a bit located in a register address, a symbol "." following by a number reflecting the bit location starting from 0 to 7 is used. For example, 0x05.2 refers to bit 2, MSB, in the register address 0x05.

To refer to a set of consecutive bits located in a register address, a format ".[MSB:LSB]" is used after a register address. For example, a value of 0x05.[3:0] refers to bit 3, 2, 1 and 0 in the register 0x05.

To refer to a binary value in some registers, the letter "b" is placed at the end of binary number. For an example "0101b".

To refer to logic level, the number in single quote '1' and '0' are used to refer to binary logic level.



6.2. Tools and Software

- Reference Design

6.3. Documentation Support

Datasheet and Factsheet

- [RE31 Data Sheet](#)
- [RE31 Fact Sheet](#)

Application Note

- [RE31 with Felica Card](#)

6.4. Contact Information

Tel: +66 2 589 9991

Fax: +66 2 589 8881

Email: info@sic.co.th



7. Legal Information

7.1 Disclaimer

- The information described herein is subject to change without notice.
- Although the IC contains a static electricity protection circuit, static electricity or voltage that exceeds the limit of the protection circuit should not be applied.
- SIC assumes no responsibility for how this IC is used in products created using this IC or for the specifications of that product, nor does SIC. Assume any responsibility for any infringement of patents or copyrights by-products that include this IC either in Thailand or in other countries.
- SIC is not responsible for any problems caused by circuits or diagrams described herein whose related industrial properties, patents, or other rights belong to third parties. The application circuit examples explain typical applications of the products and do not guarantee the success of any specific mass-production design.
- The use of the information described herein for other purposes and/or reproduction or copying without the express permission of SIC is strictly prohibited.
- The products described herein cannot be used as part of any device or equipment affecting the human body, such as exercise equipment, medical equipment, security systems, gas equipment, or any apparatus installed in airplanes and other vehicles, without prior written permission of SIC.
- Although SIC exerts the greatest possible effort to ensure high quality and reliability, the failure or malfunction of semiconductor products may occur. The user of these products should, therefore, give thorough consideration to safety design, including redundancy, fire-prevention measures, and malfunction prevention, to prevent any accidents, fires, or community damage that may ensue.

