



IQS227D/DP DATASHEET

Single channel capacitive proximity
and touch controller

The **IQS227D/DP** ProxSense® IC is a fully integrated Self Capacitive (IQS227D) or Mutual Capacitive (IQS227DP) sensor with dual outputs (Touch and Proximity outputs).

Features

- > **Sub 5µA** in Low Power Mode while sensing Proximity
- > **Automatic Tuning Implementation (ATI)** - Automatic tuning of sense electrode
- > **Internal Capacitor Implementation (ICI)** – reference capacitor on-chip
- > Supply voltage: 2.4V to 5.5V
- > Minimum external components
- > Data streaming option
- > Advanced on-chip digital signal processing
- > User selectable (OTP):
 - 4 Power Modes
 - IO sink / source
 - Time-out for stuck key
 - Output mode (Direct / Latch / Toggle)
 - Proximity and Touch Button sensitivity

RoHS2
Compliant



6 pin DFN-6

Representations only, not actual markings

Applications

- > LCD, Plasma & LED TVs
- > GSM cellular telephones – On ear detection / touch keys
- > LED flashlights or headlamps
- > White goods and appliances
- > Office equipment, toys, sanitary ware
- > Flame proof, hazardous environment Human Interface Devices
- > Proximity detection enables backlight activation
- > Wake-up from standby applications
- > Replacement for electromechanical switches
- > Find-In-The-Dark (FITD) applications
- > Automotive: Door pocket lighting, electric window control
- > GUI trigger on Proximity detected.

Available options

T _A	DFN-6	DFN-12
-40°C to 85°C	IQS227D	IQS227DP



Contents

IQS227D DATASHEET	1
1 OVERVIEW	5
1.1 APPLICABILITY.....	5
1.2 ANALOGUE FUNCTIONALITY	5
2 PACKAGING AND PIN-OUT	6
2.1 IQS227D 6	
2.1.1 Pin-out	6
2.2 IQS227DP	7
2.2.1 Pin-out	7
2.2.2 Schematic.....	8
3 USER CONFIGURABLE OPTIONS	10
3.1 CONFIGURING OF DEVICES	10
4 MEASURING CAPACITANCE USING THE CHARGE TRANSFER METHOD.....	12
5 DESCRIPTIONS OF USER OPTIONS	12
5.1 PROXIMITY / TOUCH SENSOR	13
5.2 LOGIC SELECT FOR OUTPUTS	13
5.3 OUTPUT PIN FUNCTION	13
5.3.1 Output function: Active	13
5.3.2 Output function: Latch (for t_{LATCH}).....	13
5.3.3 Output function: Toggle	14
5.4 PROXIMITY THRESHOLD.....	14
5.5 TOUCH THRESHOLD	14
5.6 POWER MODES.....	15
5.7 BASE VALUES	16
5.8 CHARGE TRANSFER	16
5.9 ATI TARGET COUNTS	16
5.10 FILTERS USED BY THE IQS227D	16
5.10.1 Long Term Average (LTA).....	16
5.10.2 IIR Raw Data filter	17
6 DATA STREAMING MODE	17
6.1 I ² C	18
7 AUTO TUNING IMPLEMENTATION (ATI).....	18
7.1 AUTOMATIC ATI	18
7.2 IQS227D NOISE IMMUNITY.....	19
8 ELECTRICAL SPECIFICATIONS.....	20
8.1 ABSOLUTE MAXIMUM SPECIFICATIONS	20
8.2 GENERAL CHARACTERISTICS	20
8.3 OUTPUT CHARACTERISTICS	21
8.4 PACKAGING INFORMATION	22
8.5 PACKAGE MSL	23
9 DATASHEET AND PART-NUMBER INFORMATION	24
9.1 ORDERING INFORMATION.....	24



9.2 STANDARD DEVICES.....	24
9.3 DEVICE MARKING – TOP.....	26
APPENDIX A. MEMORY MAP.....	27
APPENDIX B. CONTACT INFORMATION.....	31



List of Abbreviations

ATI	Automatic Tuning Implementation
BP	Boost Power Mode
CS	Counts (Number of Charge Transfers)
C _s	Internal Reference Capacitor
EMI	Electromagnetic Interference
ESD	Electro-Static Discharge
FTB/EFT	(Electrical) Fast Transient Bursts
GND	Ground
HC	Halt Charge
LP	Low Power Mode
LTA	Long Term Average
ND	Noise Detect
THR	Threshold



1 Overview

The IQS227D is a single channel capacitive proximity and touch controller with an internal voltage regular and reference capacitor (C_s).

The IQS227D devices have dedicated pin(s) for the connection of sense electrodes (C_x) and output pins for proximity events on POUT and touch event on TOUT. The output pins can be configured for various output methods including a I²C data streaming option on TOUT and POUT.

Device configuration is determined by one time programmable (OTP) options.

The devices automatically track slow varying environmental changes via various filters,

detect noise and has an Automatic Tuning Implementation (ATI) to tune the device sense electrode(s). The IQS227D is built on ProxSense® low voltage platform ideal for battery application (down to 2.4V).

1.1 Applicability

All specifications, except where specifically mentioned otherwise, provided by this datasheet are applicable to the following ranges:

- > Temperature:
 - IQS227D: -40°C to +85°C
- > Supply voltage (V_{DDHI}): 2.4V to 5.5V

1.2 Analogue Functionality

The analogue circuitry measures the capacitance of a sense electrode attached to the C_x pin through a charge transfer process that is periodically initiated by the digital circuitry. The measuring process is referred to a conversion and consists of the discharging of reference capacitor and C_x , the charging of C_x and then a series of charge transfers from C_x to C_s until a trip voltage is reached. The number of charge transfers required to reach

the trip voltage is referred to as the Counts (CS).

The capacitance measurement circuitry makes use of an internal C_s and voltage reference (V_{REG}).

The analogue circuitry further provides functionality for:

- > Power on reset (POR) detection.
- > Reset detection.



2 Packaging and Pin-out

2.1 IQS227D

The IQS227D is available in a DFN-6 package.

2.1.1 Pin-out

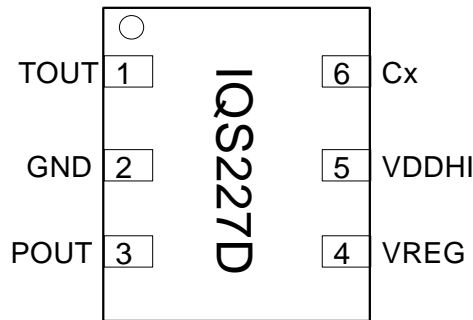

Figure 2-1: Pin-out of IQS227D in DFN-6 package.

Table 2-1: Pin-out description.

IQS227D			
Pin	Name	Type	Function
1	TOUT	Digital Out	Touch Output
2	GND	Ground	GND Reference
3	POUT	Digital Out	Proximity Output
4	VREG	Analogue Output	Internal Regulator Pin
5	VDDHI	Supply Input	Supply Voltage Input
6	CX	Analogue I/O	Sense Electrode



2.2 IQS227DP

The IQS227DP is available in a DFN-12 package.

2.2.1 Pin-out

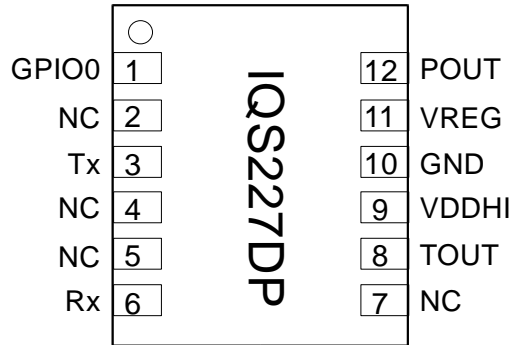

Figure 2-2: Pin-out of IQS227DP in DFN-12 package.

Table 2-2: Pin-out description.

IQS227DP			
Pin	Name	Type	Function
1	GPIO0	Digital I/O	Input
2	NC	-	-
3	TX	Analogue I/O	Sense Electrode
4	NC	-	-
5	NC	-	-
6	RX	Analogue I/O	Sense Electrode
7	NC	-	-
8	TOUT	Digital Out	Touch Output
9	VDDHI	Supply Input	Supply Voltage Input
10	GND	Ground	GND Reference
11	VREG	Analogue Output	Internal Regulator Pin
12	POUT	Digital Out	Proximity Output



2.2.2 Schematic

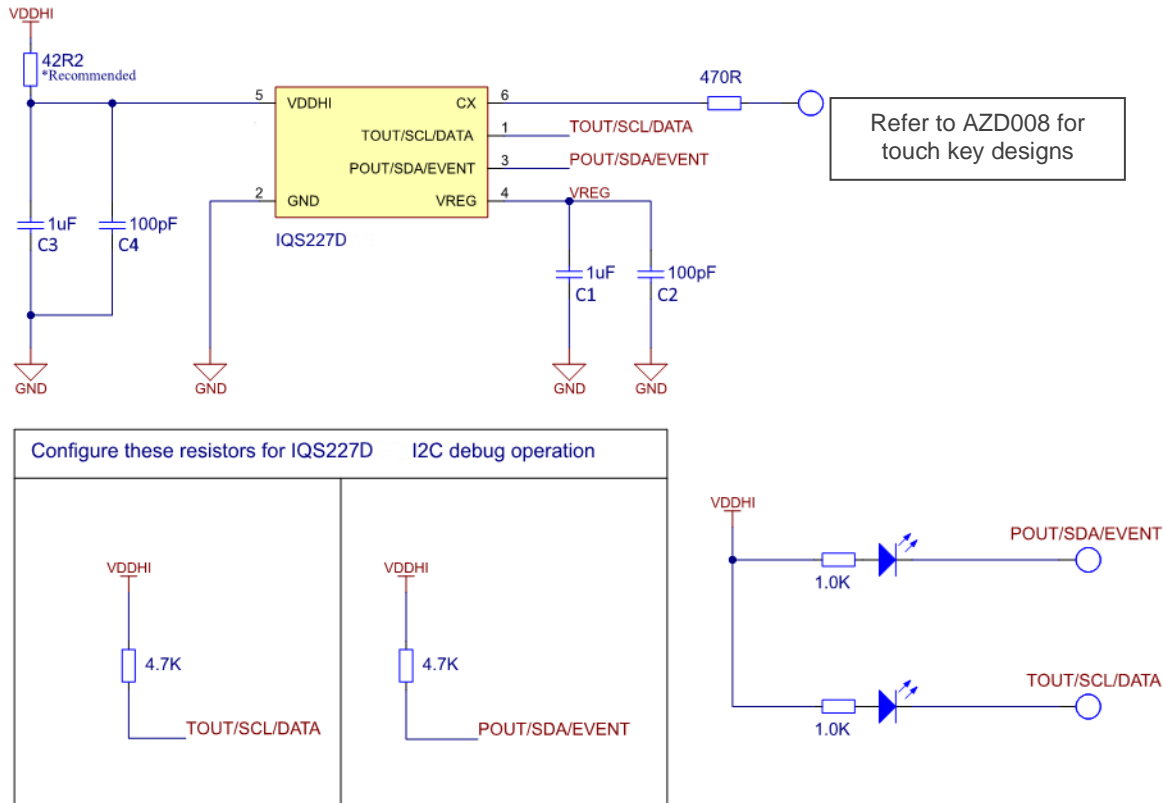

Figure 2-3: Typical application schematic of IQS227D. 100pF capacitors are optional for added RF immunity. Place all decoupling capacitors (on VDDHI and VREG) as close to the IC as possible.

Where a system level ESD strike is found to cause the IC to go into ESD induced latch-up, it is suggested that the supply current to the IQS227D IC is limited by means of a series resistor that could limit the maximum supply current to the IC to <80mA.

The 1uF capacitors on VDDHI and VREG are for default power mode. Please see Table 2.3 to select the correct capacitors for low power modes.

The 470Ω series resistor on the Cx pin is added for ESD protection.

2.2.3 Recommended Capacitor Values

The 1uF VREG capacitor value is chosen to ensure VREG remains above the maximum BOD specification stated in Table 8-2. The combination of the 1uF VREG capacitor and the 1uF VDDHI capacitor is chosen to prevent a potential ESD issue.



Recommended values to prevent this is shown in Table 2.1.

Table 2.1 VDDHI and VREG capacitor size recommendation to prevent ESD issues with typical hardware combinations

Low power scan time	8ms (default) - 32ms	64ms	128ms	160ms
Capacitor recommendation	C1 = 1µF C3 = 1µF	C1 = 4.7µF C3 = 2.2µF	C1 = 4.7µF C3 = 2.2µF	C1 = 4.7µF C3 = 2.2µF

2.2.4 Exception to recommended capacitor values

In applications where the VDDHI source has high internal resistance or a high resistance path, it will be required to ensure $C3 > C1$ to prevent a VDDHI BOD after the IC sleep cycle (see Figure 4.12).

Table 2.2 Capacitor Values for VDDHI and VREG under certain supply voltage condition

Low power scan time	8ms (default) - 32ms	64ms	128ms	160ms
Capacitor recommendation	C1 = 1µF C3 = 1µF	C1 = 2.2µF C3 = 4.7µF	C1 = 4.7µF C3 = 10µF	C1 = 4.7µF C3 = 10µF



3 User Configurable Options

The IQS227D provides One Time Programmable (OTP) user options (each option can be modified only once). The device is fully functional in the default state. OTP options are intended for specific applications.

The configuration of the device can be done on packaged devices or in-circuit. In-circuit configuration may be limited by values of external components chosen.

A number of standard device configurations are available. Azoteq can supply pre-configured devices for large quantities.

3.1 Configuring of Devices

Azoteq offers a Configuration Tool (CT210) and accompanying software (USBProg.exe) that can be used to program the OTP user options for prototyping purposes.

Alternate programming solutions of the IQS227D also exist. For further enquiries regarding this matter please contact Azoteq at ProxSenseSupport@azoteq.com or the local distributor

Table 3-1: User Selectable Configuration Options: Bank 0 (0xC4H) – IQS227D000000xxDNR

T_FUNC	P_FUNC	LOGIC	T_THR2	T_THR1	T_THR0	P_THR1	P_THR1
bit 7							bit 0
Bank0: bit 7	T_FUNC: Touch Function 0 = Normal 1 = Toggle			Section 5.3			
Bank0: bit 6	P_FUNC: Proximity Function 0 = Normal 1 = Latch			Section 5.3			
Bank0: bit 5	LOGIC: I/O's Output Logic Select 0 = Active Low 1 = Active High			Section 5.2			
Bank0: bit 4-2	T_THR: Touch Thresholds 000 = 72/256 001 = 8/256 010 = 24/256 011 = 48/256 100 = 96/256 101 = 128/256 110 = 160/256 111 = 192/256			Section 5.5			
Bank0: bit 1-0	P_THR: Proximity Thresholds 00 = 4 01 = 2 10 = 8 11 = 16			Section 5.4			



Table 3-2: : User Selectable Configuration Options: Bank 1 – Full ATI (0xC5H) – IQS227D0000xx00DNR

t _{HALT1}	t _{HALT0}	~	~	~	BASE ₂	BASE ₁	BASE ₀
bit 7					bit 0		
Bank1: bit 7-6	t_{HALT}: Halt times 00 = 20 seconds 01 = 40 seconds 10 = Never 11 = Always (Prox on 40s)				Section 5.10		
Bank1: bit 5-3	Not used						
Bank1: bit 2-0	BASE: Base Value 000 = 200 001 = 50 010 = 75 011 = 100 100 = 150 101 = 250 110 = 300 111 = 500				Section 5.7		

Table 3-3: User Selectable Configuration Options: Bank 2 (0xC6H) – IQS227D00xx0000DNR

STREAM	TRANS	COMMS	ND	Target	~	LP1	LP0
bit 7					bit 0		
Bank2: bit 7	STREAM: Streaming Method 0 = Standalone 1 = 2-wire (I ² C)				Section 6.1		
Bank2: bit 6	TRANS: Charge Transfer Frequency 0 = 512kHz 1 = 250kHz				Section 5.8		
Bank2: bit 5	COMMS: Streaming 0 = Disabled 1 = Enabled				Section 6		
Bank2: bit 3	Target: ATI target counts 0 = 1024 1 = 512				Section 5.9		
Bank2: bit 1-0	LP: Low Power Modes 00 = BP (9ms) 01 = NP (128ms) 10 = LP1 (256ms) 11 = LP2 (512ms)				Section 5.6		



4 Measuring capacitance using the *Charge Transfer* method

The *charge transfer* method of capacitive sensing is employed on the IQS227D. (The charge transfer principle is thoroughly described in the application note: “AZD004 - Azoteq Capacitive Sensing”.)

A charge cycle is used to take a measurement of the capacitance of the sense electrode (connected to Cx) relative to ground. It consists of a series of pulses charging Cx and discharging Cx to the reference capacitor, at the charge transfer frequency (FCX - refer to Section 8). The number of the pulses required to reach a trip voltage on the reference capacitor is referred to as **Count Value** (CS) which is the instantaneous capacitive measurement. The Counts (CS) are used to determine if either a physical contact or proximity event occurred (refer to section 5.10.1), based on the change in Counts (CS) detected. The typical values of CS, without a touch or proximity condition range between 650 and 1150 Counts, although higher and lower counts can be used based on the application

requirements. With counts larger than +/-1150 the gain of the system may become too high causing unsteady operation.

The IQS227D schedules a charge cycle every t_{SAMPLE} seconds to ensure regular samples for processing of results. The duration of the charge cycle is defined as t_{CHARGE} . (refer to 0) and varies according to the counts required to reach the trip voltage. Following the charge cycle other activities such as data streaming is completed (if in streaming mode), before the next charge cycle is initiated.

Please note: Attaching a probe to the Cx pin will increase the capacitance of the sense plate and therefore C_s . This may have an immediate influence on the counts (decrease t_{CHARGE}) and cause a proximity or touch event. After t_{HALT} seconds the system will adjust to accommodate for this change. If the total load on Cx, with the probe attached is still lower than the maximum Cx load the system will continue to function normally after t_{HALT} seconds with the probe attached.

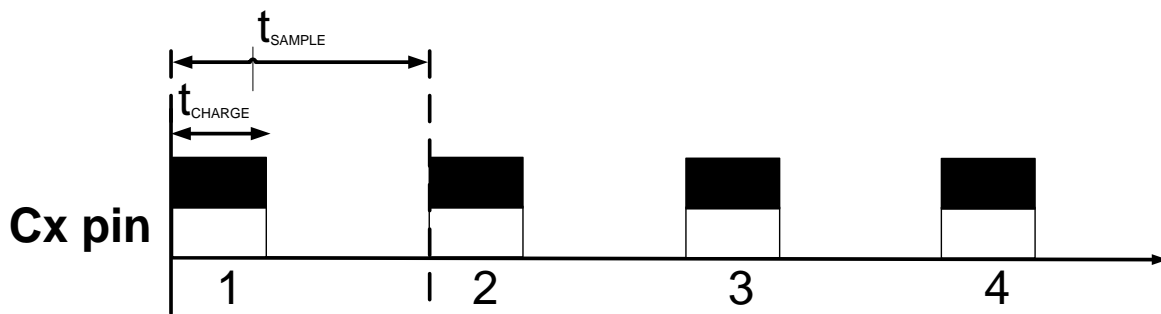

Figure 4-1: Charge cycles as can be seen on Cx.

5 Descriptions of User Options

This section describes the individual user programmable options of the IQS227D in more detail.

User programmable options are programmed to One Time Programmable (OTP) fuse registers (refer to Section 3).

Note:

- > HIGH=Logical '1' and LOW=Logical '0'.
- > The following sections are explained with POUT and TOUT taken as 'Active LOW'.
- > The default is always where bits are set to 0.

Refer to section 0 for the sourcing and sinking capabilities POUT and TOUT. These pins are sourced from V_{DDHI} and will be turned HIGH (when active high) for a minimum time of t_{HIGH} ,



and LOW for a minimum time of t_{LOW} (when active low).

5.1 Proximity / Touch Sensor

The IQS227D provides a Proximity output on POUT and a Touch output on TOUT, and does not need to be configured.

5.2 Logic select for outputs

The logic used by the device can be selected as active HIGH or active LOW. The output pins, POUT and TOUT, will function based on this selection. The I/O's are push pull in both directions and does not require a pull-up resistor. When configured as Active High, the I/O's will remain high at POR until ATI has been completed. ATI times will vary based on the capacitive load on the sensor, but typically do not exceed 500ms.

Configuration: Bank0 bit5

LOGIC: Output logic select -

Bit	Selection
0	Active Low
1	Active High

5.3 Output pin function

Various options for the function of the output pin(s) are available. These are selected as follow:

Configuration: Bank0 bit7-6

FUNC1:FUNC0 OUTPUT Pins' functions

Bit	Selection
00	POUT active, TOUT active
01	POUT latch, TOUT active
10	POUT active, TOUT toggle
11	POUT latch, TOUT toggle

5.3.1 Output function: Active

With a Proximity or Touch event, the output pin will change to LOW and stay LOW for as long as the event remains (see Figure 5-1 Also refer to the use of t_{HALT} section 5.10.1 that may cause the termination of the event.

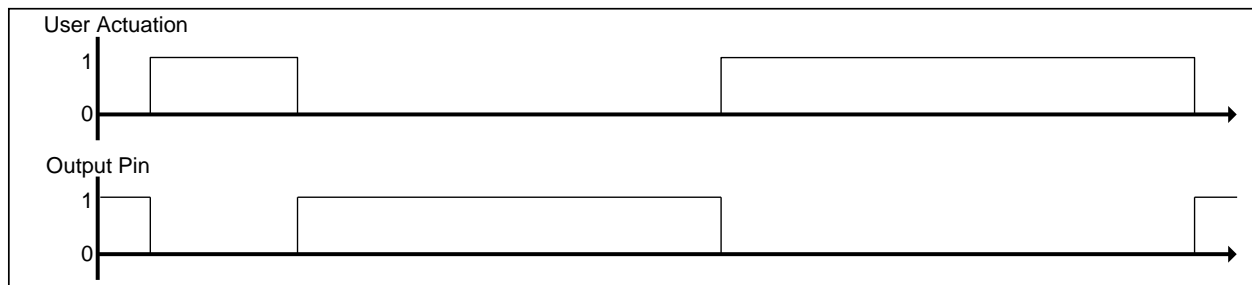

Figure 5-1: Active Mode Output Configuration

5.3.2 Output function: Latch (for t_{LATCH})

With a Proximity or Touch event, the output pin will latch LOW for t_{LATCH} seconds (4 seconds).

When the event terminates prior to t_{LATCH} the output pin will remain LOW.

When the event remains active longer than t_{LATCH} the output pin will remain LOW as long as the event remains active (see Figure 5-2)

When a subsequent event is made before the latch time (4 seconds) has passed, the timer will reset and the output will remain low for another duration of t_{LATCH} seconds (4 seconds). For more details see Figure 5-2.

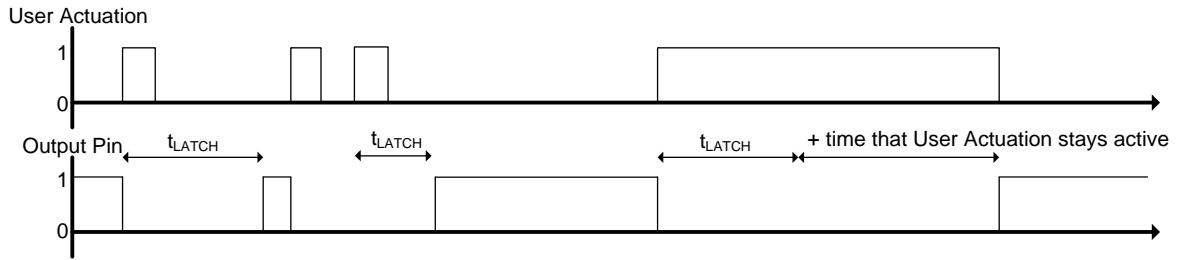

Figure 5-2: Latch Mode Output Configuration

5.3.3 Output function: Toggle

The output pin will toggle with every Proximity or Touch event occurring. Thus when an event

occurs and the output is LOW the output will become HIGH and when the output is HIGH the output will become LOW (see Figure 5-3)

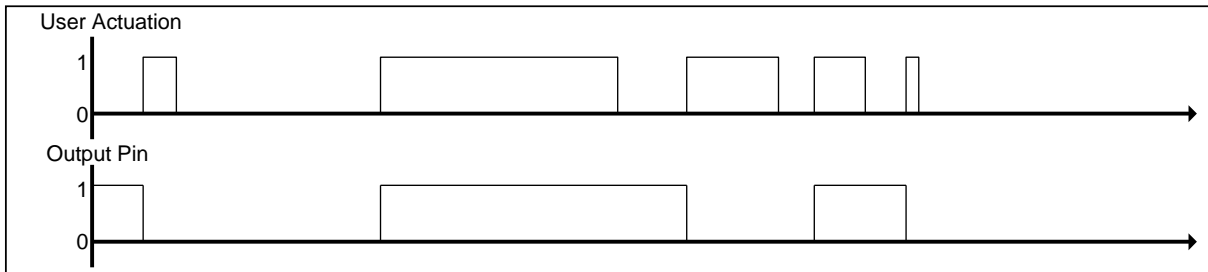

Figure 5-3: Toggle Mode Output Configuration

5.4 Proximity Threshold

The IQS227D has 4 proximity threshold settings. The proximity threshold is selected by the designer to obtain the desired sensitivity and noise immunity. The proximity event is triggered based on the selected proximity threshold; the Counts (CS) and the LTA (Long Term Average). The threshold is expressed in terms of counts; the same as CS (refer to 0)

$$P_{THR} \leq LTA - CS$$

Where LTA is the Long Term Average (refer to 5.10.1)

5.5 Touch Threshold

The IQS227D has 8 touch threshold settings. The touch threshold is selected by the designer to obtain the desired touch sensitivity. The touch threshold is expressed as a fraction of the LTA as follows:

$$T_{THR} = \frac{x}{256} \times LTA$$

The touch event is triggered based on T_{TH} , Counts (CS) and LTA. A touch event is

Configuration: Bank0 bit1-0

P_{THR1}:P_{THR0} Proximity Thresholds

Bit	Selection
00	4
01	2 (Most sensitive)
10	8
11	16 (Least sensitive)

A proximity event is identified when for at least 6 consecutive samples the following equation holds:

identified when for at least 3 consecutive samples the following equation holds:

$$T_{THR} \leq LTA - CS$$

With lower average counts (therefore lower LTA) values the touch threshold will be lower and vice versa.



Configuration: Bank0 bit4-2

T _{THR2} :T _{THR0} : Touch Thresholds	
Bit	Selection
000	72/256
001	8/256 (Most sensitive)
010	24/256
011	48/256
100	96/256
101	128/256
110	160/256
111	192/256 (Least sensitive)

5.6 Power Modes

The IQS227D has four power modes specifically designed to reduce current consumption for battery applications.

The power modes are basically implemented around the occurrence of charge cycle every t_{SAMPLE} seconds (refer to Table 5-1). The fewer charge transfer cycles that need to occur per second the lower the [power consumption](#) (but decreased response time).

During Boost Power Mode (BP), charge cycles are initiated approximately every 9ms.

While in any power mode the device will zoom to BP whenever an existing count sample (CS) indicates a possible proximity or touch event. The device will remain in BP for t_{ZOOM} seconds and then return to the selected power mode. The Zoom function allows reliable detection of events with counts being produced at the BP rate.

Table 5-1: Power Mode configuration: Bank2 bit1-0

Bit	Power Mode timing	t _{SAMPLE} (ms)
00	t _{BP} (default)	BP (9ms)
01	t _{NP}	128
10	t _{LP1}	256
11	t _{LP2}	512

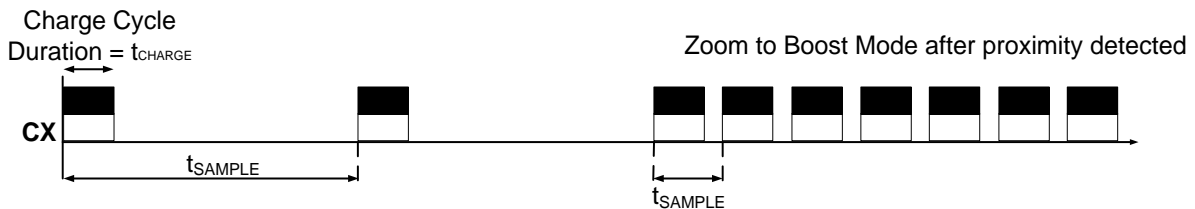

Figure 5-4: LP Modes: Charge cycles



5.7 Base Values

The sensitivity of the IQS227D can be changed by adjusting the base value of the ATI algorithm, and as a result changing the compensation required to reach the target.

$$Sensitivity = \frac{TARGET}{BASE}$$

The target of the IQS227D is fixed at 1000 counts.

Configuration: [Bank1 bit2-0](#)

BASE: Base Value Select -

Bit	Selection
000	200
001	50
010	75
011	100
100	150
101	250
110	300
111	500

5.8 Charge Transfer

The charge transfer frequency of the IQS227D is adjustable. Changing the transfer frequency will affect sensitivity and response rate. Two options are available:

Configuration: [Bank2 bit6](#)

TRANS: Charge Transfer Frequency

Bit	Selection
0	512kHz
1	250kHz

5.9 ATI Target Counts

The target of the ATI algorithm can be adjusted between 1024 (default) and 512 counts. When less sensitivity is required, the lower counts will also increase response rate.

Configuration: [Bank2 bit3](#)

Target: ATI Target Counts

Bit	Selection
0	1024
1	512

5.10 Filters used by the IQS227D

The IQS227D devices employ various signal processing functions that includes the execution of various filters as described below.

5.10.1 Long Term Average (LTA)

Capacitive touch devices detect changes in capacitance that are not always related to the intended proximity or touch of a human. This is a result of changes in the environment of the sense plate and other factors. These changes need to be compensated for in various manners in order to reliably detect touch events and especially to detect proximity events. One mechanism the IQS227D employs is the use of a Long Term Averaging filter (IIR type filter) which tracks slow changes in the environment (expressed as changes in the counts). The result of this filter is a Long Term Average (LTA) value that forms a dynamic reference used for various functions such as identification of proximity and touch events.

The LTA is calculated from the counts (CS). The filter only executes while no proximity or touch event is detected to ensure compensation only for environmental changes. However there may be instances where sudden changes in the environment or changes in the environment while a proximity or touch event has been detected cause the counts to drift away from the LTA. To compensate for these situations a Halt Timer (t_{HALT}) has been defined.

The Halt Timer is started when a proximity or touch event occurs and when it expires the LTA filter is recalibrated. Recalibration causes $LTA < CS$, thus the disappearance of proximity or touch events (refer to 5.4 and 5.5).

The designer needs to select a Halt Timer value to best accommodate the required application.



Configuration: Bank1 bit7-6

t_{HALT1}:t_{HATL0}: Halt time of Long Term Average	
Bit	Selection
00	20 seconds
01	40 seconds
10	NEVER
11	ALWAYS (Proximity on 40 seconds)

Notes:

- > The “NEVER” option indicates that the execution of the filters will never be halted.
- > With the ‘ALWAYS’ option and the detection of a proximity event the execution of the filter will be halted for only 40 seconds and with the detection of a touch event the execution of the filter will be halted as long as the touch condition applies.

Refer to Application note “AZD024 - Graphical Representation of the IIR Filter” for detail regarding the execution of the LTA filter.

5.10.2 IIR Raw Data filter

The extreme sensitivity of the IQS227D makes it susceptible to external noise sources. This causes a decreased signal to noise (S/N) ratio, which could potentially cause false event detections.

Noise can also couple into the device as a result of poor PCB, sense electrode design and other factors influencing capacitive sensing devices.

In order to compensate for noise the IQS227D uses an IIR filter on the raw data to minimize result of noise in the counts. This filter is implemented on all of the IQS227D devices, and cannot be disabled.

6 Data Streaming Mode

The IQS227D has the capability to stream data to a MCU. This provides the designer with the capability to obtain the parameters within the device in order to aid design into applications. Data streaming may further be used by an MCU to control events or further process results obtained from the IQS227D devices. Data streaming is performed through I²C communication (SDA on POUT, SCL on TOUT). Data Streaming can be enabled as indicated below:

Configuration: Bank2 bit7

COMMS: Data Streaming	
Bit	Selection
0	Disabled
1	Enabled

Configuration: Bank2 bit5

STREAMING: Data streaming mode	
Bit	Selection
0	Standalone
1	I ² C

Data streaming is initiated by the IQS227D. When data streaming is enabled data is sent following each charge.



6.1 I²C

The IQS227D also allow for I²C streaming for debugging. Data Streaming can be changed to I²C as shown below:

Configuration: Bank2 bit7: Streaming Mode

Bit	Selection
0	Standalone
1	I ² C Streaming

The Memory Map for the IQS227D can be found in Appendix A.

The IQS227D can communicate on an I²C compatible bus structure. Note that 4.7kΩ pull-up resistors should be placed on SDA and SCL.

The Control byte indicates the 7-bit device address (0x44H) and the Read/Write indicator bit.

7 Auto Tuning Implementation (ATI)

ATI is a sophisticated technology implemented in the latest generation ProxSense® devices that optimises the performance of the sensor in a wide range of applications and environmental conditions (refer to application note AZD0027 - Auto Tuning Implementation).

ATI makes adjustments through external reference capacitors (as required by most other solutions) to obtain optimum performance.

ATI adjusts internal circuitry according to two parameters, the ATI multiplier and the ATI compensation. The ATI multiplier can be viewed as a coarse adjustment and the ATI compensation as a fine adjustment.

The adjustment of the ATI parameters will result in variations in the counts and sensitivity. Sensitivity can be observed as the change in current sample as the result of a fixed change in sensed capacitance. The ATI parameters have been chosen to provide significant overlap. It may therefore be possible to select various combinations of ATI multiplier and ATI compensation settings to obtain the same count value. The sensitivity of the various options may however be different for the same count value.

7.1 Automatic ATI

The IQS227D implements an automatic ATI algorithm. This algorithm automatically adjusts the ATI parameters to optimise the sensing electrodes connection to the device.

The device will execute the ATI algorithm whenever the device starts-up and when the counts are not within a predetermined range.

While the Automatic ATI algorithm is in progress this condition will be indicated in the streaming data and proximity and touch events cannot be detected. The device will only briefly remain in this condition and it will be entered only when relatively large shifts in the counts has been detected.

The automatic ATI function aims to maintain a constant count value, regardless of the capacitance of the sense electrode (within the maximum range of the device).

The effects of auto-ATI on the application are the following:

- > Automatic adjustment of the device configuration and processing parameters for a wide range of PCB and application designs to maintain an optimal configuration for proximity and touch detection.
- > Automatic tuning of the sense electrode at start-up to optimise the sensitivity of the application.
- > Automatic re-tuning when the device detects changes in the sensing electrodes capacitance to accommodate a large range of changes in the environment of the application that influences the sensing electrode.
- > Re-tuning only occurs during device operation when a relatively large sensitivity reduction is detected. This is to ensure smooth operation of the device during operation.
- > Re-tuning may temporarily influence the normal functioning of the device, but in most instances the effect will be hardly noticeable.
- > Shortly after the completion of the re-tuning process the sensitivity of a Proximity detection may be reduced slightly for a few seconds as internal filters stabilises.



Automatic ATI can be implemented so effectively due to:

- > Excellent system signal to noise ratio (SNR).
- > Effective digital signal processing to remove AC and other noise.
- > The very stable core of the devices.
- > Built in capability to accommodate a large range of sensing electrode capacitances.

7.2 IQS227D Noise Immunity

The IQS227D has advanced immunity to RF noise sources such as GSM cellular telephones, DECT, Bluetooth and WIFI devices. Design guidelines should however be followed to ensure the best noise immunity. The design of capacitive sensing applications can encompass a large range of situations but as a summary the following should be noted to improve a design:

- > A ground plane should be placed under the IC, except under the Cx line.
- > All the tracks on the PCB must be kept as short as possible.
- > The capacitor between V_{DDHI} and GND as well as between V_{REG} and GND, must be placed as close as possible to the IC.
- > A 100 pF capacitor can be placed in parallel with the 1uF capacitor between V_{DDHI} and GND. Another 100 pF capacitor can be placed in parallel with the 1uF capacitor between V_{REG} and GND.
- > When the device is too sensitive for a specific application a parasitic capacitor (max 5pF) can be added between the Cx line and ground.
- > Proper sense electrode and button design principles must be followed.
- > Unintentional coupling of sense electrode to ground and other circuitry must be limited by increasing the distance to these sources or making use of the driven shield.
- > In some instances, a ground plane some distance from the device and sense electrode may provide significant shielding from undesired interference.
- > When then the capacitance between the sense electrode and ground becomes too large the sensitivity of the device may be

influenced.

Note: ND input enable is a legacy input and is not recommended for use in new designs. The input has been desensitized by default and is not tested to trigger at a specific RF input power level



8 Electrical Specifications

8.1 Absolute Maximum Specifications

Exceeding these maximum specifications may cause damage to the device.

Operating temperature	-40°C to 85°C
Supply Voltage ($V_{DDHI} - V_{SS}$)	5.5V
Maximum pin voltage (T_{OUT}, P_{OUT})	$V_{DDHI} + 0.3V$
Minimum pin voltage ($V_{DDHI}, V_{REG}, T_{OUT}, P_{OUT}, C_x$)	$V_{SS} - 0.3V$
Minimum power-on slope	100V/s
HBM ESD protection ($V_{DDHI}, V_{REG}, V_{SS}, T_{OUT}, P_{OUT}, C_x$)	8kV

8.2 General Characteristics

The IQS227D devices are rated for supply voltages between 3V and 5.5V.

Table 8-1: IQS227D General Operating Conditions (Self)

DESCRIPTION	Conditions	PARAMETER	MIN	TYP	MAX	UNIT
Supply voltage		V_{DDHI}	2.4	~	5.5	V
Internal regulator output	$2.4 \leq V_{DDHI} \leq 5.5$	V_{REG}	1.98	~	2.08	V
Boost operating current	$2.4 \leq V_{DDHI} \leq 5.5$	$I_{IQS227D_BP}$	~	101	~	μA
Normal operating current	$2.4 \leq V_{DDHI} \leq 5.5$	$I_{IQS227D_NP}$	~	6	~	μA
Low power operating current	$2.4 \leq V_{DDHI} \leq 5.5$	$I_{IQS227D_LP1}$	~	4.5	~	μA
Low power operating current	$2.4 \leq V_{DDHI} \leq 5.5$	$I_{IQS227D_LP2}$	~	<3.2	~	μA

Charge Transfer Timings for low power modes are found in [Section 5.6](#).

Table 8-2: Start-up and shut-down slope Characteristics

DESCRIPTION	PARAMETER	MIN	MAX	UNIT
Reset release voltage on V_{DDHI} rising edge	V_{DDHI} Reset Rising Edge (POR)	N/A	2.1	V
Reset trigger voltage on V_{DDHI} falling edge	V_{DDHI} Reset Falling Edge (BOD)	0.3	N/A	V
Reset release voltage on V_{REG} rising edge	V_{REG} Reset Rising Edge (POR)	N/A	1.8	V
Reset trigger voltage on V_{REG} falling edge	V_{REG} Reset Falling Edge (BOD)	0.3	N/A	V



8.3 Output Characteristics

Table 8-3: TOUT Characteristics

Symbol	Description	V _{OH}	Conditions	MIN	TYP	MAX	UNIT
I _{SOURCE}	Output High voltage	0.9*VDDHI	V _{DDHI} = 5.5V	~	~	TBD	mA
		0.9*VDDHI	V _{DDHI} = 5V	~	5	~	
		0.9*VDDHI	V _{DDHI} = 2.4V	TBD	~	~	
Symbol	Description	V _{OL}	Conditions	MIN	TYP	MAX	UNIT
I _{SINK}	Output Low voltage	0.1V	V _{DDHI} = 5.5V	~	~	TBD	mA
		0.1V	V _{DDHI} = 5V	~	5	~	
		0.1V	V _{DDHI} = 2.4V	TBD	~	~	

Table 8-4: POUT Characteristics

Symbol	Description	VOH	Conditions	MIN	TYP	MAX	UNIT
I _{SOURCE}	Output High voltage	0.9*VDDHI	V _{DDHI} = 5.5V	~	~	TBD	mA
		0.9*VDDHI	V _{DDHI} = 5V	~	5	~	
		0.9*VDDHI	V _{DDHI} = 2.4V	TBD	~	~	
Symbol	Description	V _{OL}	Conditions	MIN	TYP	MAX	UNIT
I _{SINK}	Output Low voltage	0.1V	V _{DDHI} = 5.5V	~	~	TBD	mA
		0.1V	V _{DDHI} = 5V	~	5	~	
		0.1V	V _{DDHI} = 2.4V	TBD	~	~	



8.4 Packaging Information

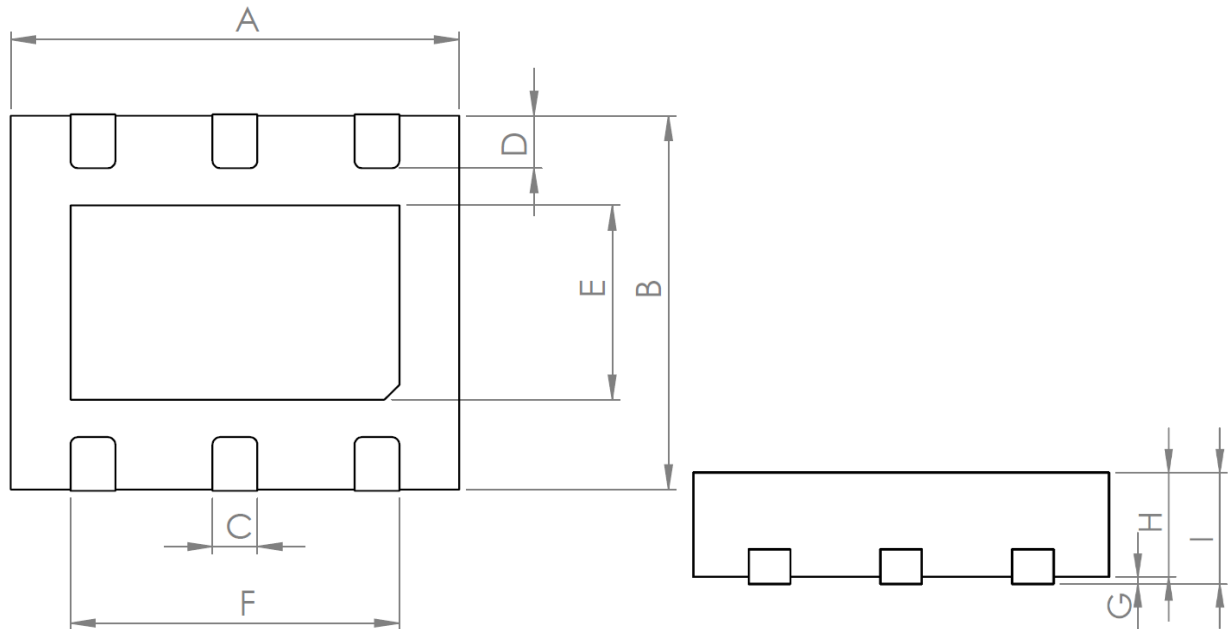

Figure 8.1 DFN-6 Packaging

Table 8.1 DFN-6 Dimensions

Dimension	Min	Max
A	3.00mm	3.00mm
B	2.50mm	2.50mm
C	0.30mm	0.30mm
D	0.35mm	0.35mm
E	1.30mm	1.30mm
F	2.20mm	2.20mm
G	0.05mm	0.05mm
H	0.75mm	0.75mm
I	0.80mm	0.80mm



8.5 Package MSL

Moisture Sensitivity Level (MSL) relates to the packaging and handling precautions for some semiconductors. The MSL is an electronic standard for the time period in which a moisture sensitive device can be exposed to ambient room conditions (approximately 30°C/85%RH see J-STD033C for more info) before reflow occur.

Table 8-5: Table 9 6: MSL

Package	Level (duration)
DFN-6	MSL 1 (Unlimited at ≤30 °C/85% RH) Reflow profile peak temperature < 260 °C for < 30 seconds



9 Datasheet and Part-number Information

9.1 Ordering Information

Orders will be subject to a MOQ (Minimum Order Quantity) of a full reel. Contact the official distributor for sample quantities. A list of the distributors can be found under the “Distributors” section of www.azoteq.com.

For large orders, Azoteq can provide pre-configured devices.

The Part-number can be generated by using USBProg.exe or the Interactive Part Number generator on the website.

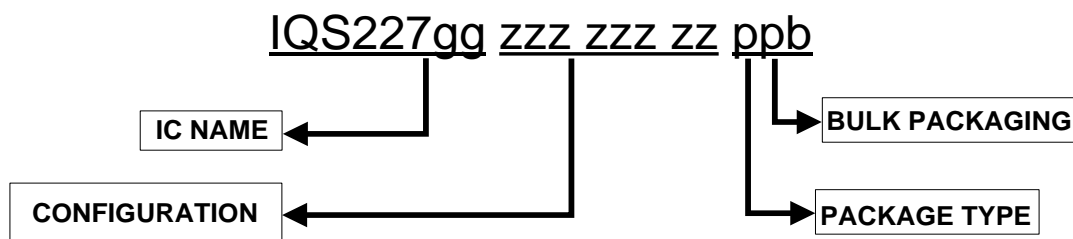

IC NAME	IQS227D	=	Self Capacitive IC with Dual Outputs
	IQS227DP	=	Projected Capacitive IC with Dual Outputs.
CONFIGURATION	zzz zzz zz	=	IC Configuration (hexadecimal)
PACKAGE TYPE	DN	=	DFN-6 (IQS227D only)
		=	DFN-12 (IQS227DP only)
BULK PACKAGING	R	=	Reel (6000pcs/reel) – MOQ = 6000pcs MOQ = 1 reel.

Orders shipped as full reels.

9.2 Standard Devices

The default (unconfigured) device will be suitable for most applications. Some popular configurations are kept in stock and do not require further programming. (Ordering codes given for Device IDs: 03 0D / 03 0E or later (the Device ID will be read in USBProg))



Table 9.1 IQS127D Standard Replacements

IQS227D Device	IQS127D Function
IQS227D-00400008DNR	Default
IQS227D-00400028DNR	Active HIGH outputs
IQS227D-00410008DNR	Normal Power Mode
IQS227D-00400088DNR	Touch Output ac Toggle



9.3 Device Marking – Top

There are 2 marking versions in circulation for IQS227D:

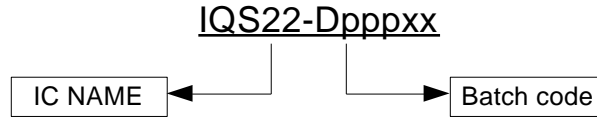

Figure 9-1: Top Marking of IQS227D

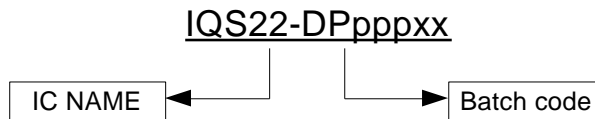

Figure 9-2: Top Marking of IQS227DP

IC NAME	22-D =	IQS227D Self Capacitive
	22-DP =	IQS227DP Mutual Capacitive
Batch Code	pppx =	Product code



Appendix A. Memory Map

Device Information

		Product Number (PROD_NR)							
		Bit	7	6	5	4	3	2	1
Access		Value							
	R	39 (Decimal)							
		Note							

		Software Number (SW_NR)							
		Bit	7	6	5	4	3	2	1
Access		Value							
	R	28 (Decimal)							
		Note							

[00H] PROD_NR

The product number for the IQS227D is 39 (decimal).

[01H] SW_NR

The software version number of the device ROM can be read in this byte. The latest software version is 28 (decimal).

		System Flags (Sys_Flags)							
		Bit	7	6	5	4	3	2	1
Access		Value							
	R	~	~	Logic	Halt	LP	ATI	ND	Zoom
		Note							

[10H] SYSFLAGS0

Bit 7: **SYSTEM_USE**

Bit 6: **SYSTEM_USE**

Bit 5: **Logic:** Logic Output Indication

0 = Active Low

1 = Active High

Bit 4: **Halt:** Indicates Filter Halt status

0 = LTA not being Halted

1 = LTA Halted

Bit 3: **LP:** Low Power Mode

0 = Sample time BP



1 = Sample time LP

Bit 2: **ATI:** Status of automated ATI routine

0 = ATI is not busy

1 = ATI in progress

Bit 1: **ND:** This bit indicates the presence of noise interference.

0 = IC has not detected the presence of noise

1 = IC has detected the presence of noise

Bit 0: **ZOOM:** Zoom will indicate full-speed charging once an undebounced proximity is detected. In BP mode, this will not change the charging frequency.

0 = IC not zoomed in

1 = IC detected undebounced proximity and IC is charging at full-speed (BP)

31H		Status								
		Bit	7	6	5	4	3	2	1	0
Access		Value							Touch	Prox
R		Note								

[31H] Status

Bit 1: **Touch:** Touch indication bit.

0 = No Touch Detected

1 = Touch Event Detected

Bit 0: **Prox:** Proximity indication bit.

0 = No Proximity Detected

1 = Proximity Event Detected

42H		Counts_Hi (CS_H)								
		Bit	7	6	5	4	3	2	1	0
Access		Value	Counts High Byte							
R		Note								



43H	Counts_Low (CS_L)								
	Bit	7	6	5	4	3	2	1	0
	Access	Value							
	R	Counts Low Byte							
	Note								

83H	LTA_Hi (LTA_H)								
	Bit	7	6	5	4	3	2	1	0
	Access	Value							
	R	Long Term Average High Byte							
	Note								

84H	LTA_Low (LTA_L)								
	Bit	7	6	5	4	3	2	1	0
	Access	Value							
	R	Long Term Average Low Byte							
	Note								

C4H	Fuse Bank 0 (FB_0)								
	Bit	7	6	5	4	3	2	1	0
	Access	Value							
	R	See Table 3-1 for more details							
	Note								

C5H	Fuse Bank 1 (FB_1)								
	Bit	7	6	5	4	3	2	1	0
	Access	Value							
	R	See Table 3-2 for more details							
	Note								



C6H		Fuse Bank 2 (FB_2)							
		Bit	7	6	5	4	3	2	1
Access		Value	See Table 3-3 for more details						
R		Note							

C7H		Fuse Bank 3 (FB_3)							
		Bit	7	6	5	4	3	2	1
Access		Value	Not used						
R		Note							

C8H		DEFAULT_COMMS_POINTER							
		Bit	7	6	5	4	3	2	1
Access		Value	(Beginning of Device Specific Data)						
R/W		Default	10H						

[C8H] Default Comms Pointer

The value stored in this register will be loaded into the Comms Pointer at the start of a communication window. For example, if the design only requires the Proximity Status information each cycle, then the *Default Comms Pointer* can be set to ADDRESS '31H'. This would mean that at the start of each communication window, the comms pointer would already be set to the Proximity Status register, simply allowing a READ to retrieve the data, without the need of setting up the address.



Appendix B. Contact Information

	USA	Asia	South Africa
Physical Address	11940 Jollyville Suite 120-S Austin TX 78750 USA	Room 501A, Block A, T-Share International Centre, Taoyuan Road, Nanshan District, Shenzhen, Guangdong, PRC	1 Bergsig Avenue Paarl 7646 South Africa
Postal Address	11940 Jollyville Suite 120-S Austin TX 78750 USA	Room 501A, Block A, T-Share International Centre, Taoyuan Road, Nanshan District, Shenzhen, Guangdong, PRC	PO Box 3534 Paarl 7620 South Africa
Tel	+1 512 538 1995	+86 755 8303 5294 ext 808	+27 21 863 0033
Email	info@azoteq.com	info@azoteq.com	info@azoteq.com

Visit www.azoteq.com

for a list of distributors and worldwide representation.

Patents as listed on www.azoteq.com/patents-trademarks/ may relate to the device or usage of the device.

Azoteq®, Crystal Driver®, IQ Switch®, ProxSense®, ProxFusion®, LightSense™, SwipeSwitch™, and the  logo are trademarks of Azoteq.

The information in this Datasheet is believed to be accurate at the time of publication. Azoteq uses reasonable effort to maintain the information up-to-date and accurate, but does not warrant the accuracy, completeness or reliability of the information contained herein. All content and information are provided on an "as is" basis only, without any representations or warranties, express or implied, of any kind, including representations about the suitability of these products or information for any purpose. Azoteq disclaims all warranties and conditions with regard to these products and information, including but not limited to all implied warranties and conditions of merchantability, fitness for a particular purpose, title and non-infringement of any third party intellectual property rights. Azoteq assumes no liability for any damages or injury arising from any use of the information or the product or caused by, without limitation, failure of performance, error, omission, interruption, defect, delay in operation or transmission, even if Azoteq has been advised of the possibility of such damages. The applications mentioned herein are used solely for the purpose of illustration and Azoteq makes no warranty or representation that such applications will be suitable without further modification, nor recommends the use of its products for application that may present a risk to human life due to malfunction or otherwise. Azoteq products are not authorized for use as critical components in life support devices or systems. No licenses to patents are granted, implicitly, express or implied, by estoppel or otherwise, under any intellectual property rights. In the event that any of the abovementioned limitations or exclusions does not apply, it is agreed that Azoteq's total liability for all losses, damages and causes of action (in contract, tort (including without limitation, negligence) or otherwise) will not exceed the amount already paid by the customer for the products. Azoteq reserves the right to alter its products, to make corrections, deletions, modifications, enhancements, improvements and other changes to the content and information, its products, programs and services at any time or to move or discontinue any contents, products, programs or services without prior notification. For the most up-to-date information and binding Terms and Conditions please refer to www.azoteq.com.