

makeblock



mCreate 3D printer

- Education Application Scenarios
- Positioning
- Main Features
- Other Features
- Specification
- mCreate VS XYZ Printing

## Education Application Scenarios



### Support for courses such as 3D design

mCreate turns abstract 3 dimensions into visual and tactile objects, facilitating the cultivation of innovation and creativity in primary and secondary schools.



### Support for club events, competitions, and maker activities

mCreate allows students to make special parts and models for club events, competitions, and other activities, developing their hands-on skills and problem-solving abilities.



### Support for higher vocational college education

mCreate brings creative industrial design from drawing to reality, boosting students' creativity and gearing them up for future careers.





# Makeblock mCreate

## Smart leveling versatile 3D printer

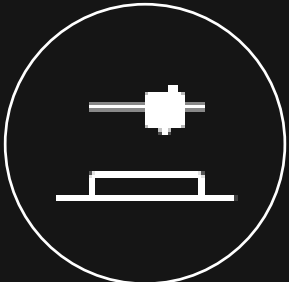

'Genius'  
Smart Leveling



Patented  
smart nozzle,  
Change nozzle  
in 3s



220\*220\*295mm  
Large Build  
Volume

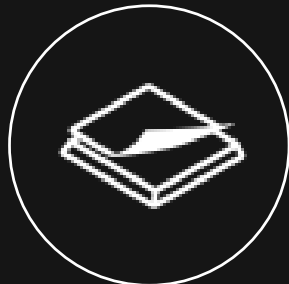

Flexible Magnetic  
Build Plate

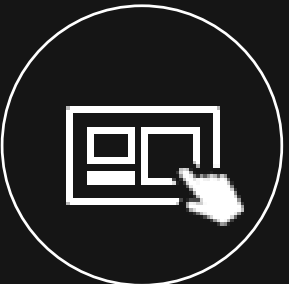

Full-color  
Touch Screen

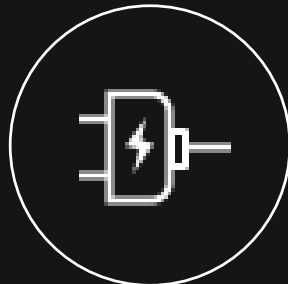

Resume Printing  
after Power  
Outage



Support STEAM  
Education



makeblock

## mCreate

mCreate is a versatile desktop 3D printer featuring the innovative Genius smart leveling technology for accurate printing. Our patented smart nozzle, flexible magnetic build plate and the ability to resume working even after a power outage, enable mCreate to deliver a remarkable print success rate and quality. By quickly switching to the laser engraving mode, the machine meets the needs of a broader range of applications in STEAM education or other creative projects. Built for materializing creativity, mCreate make ideas tangible.

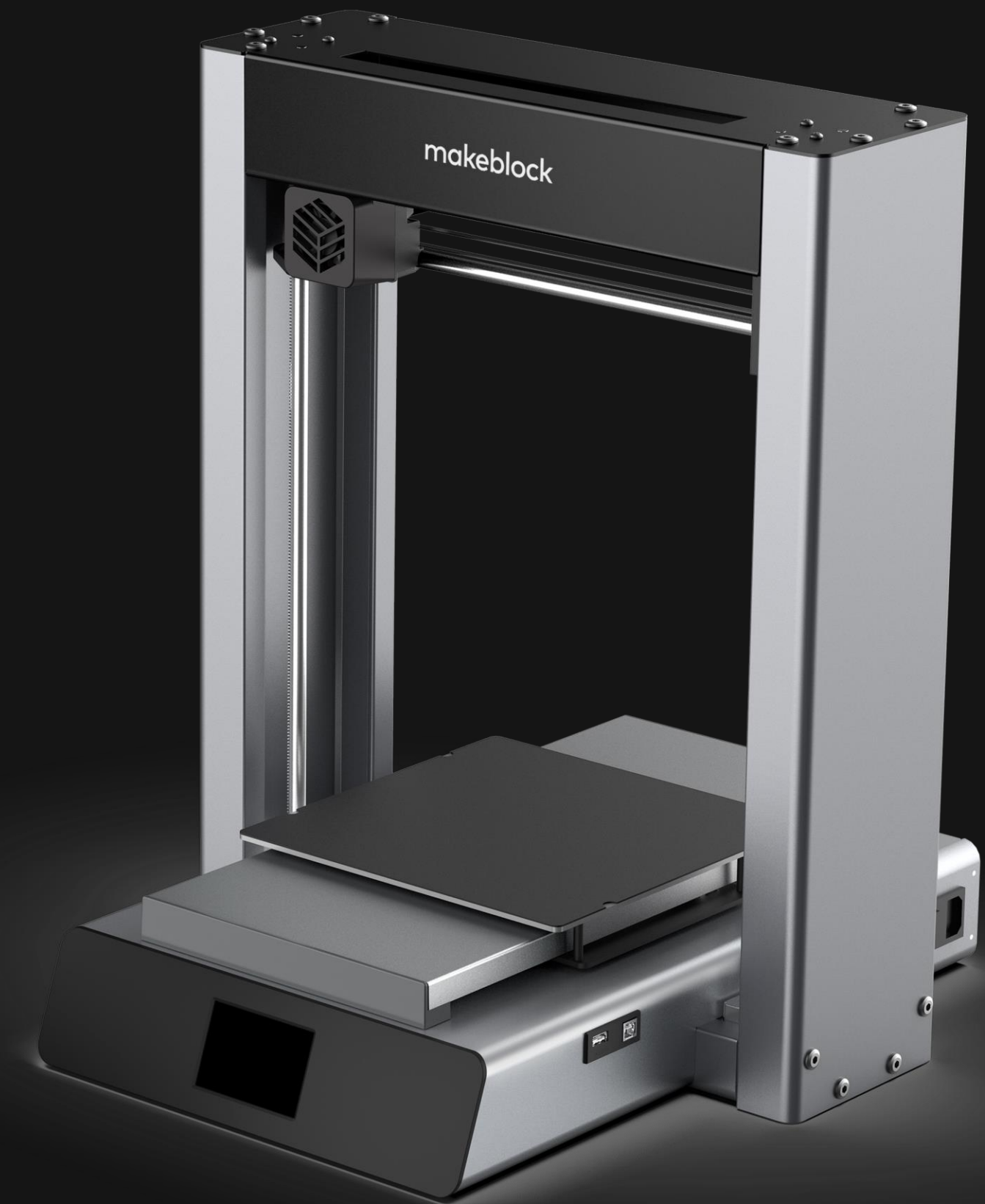

makeblock

## Main Features

Reliable &  
High printing  
success rate

New Technologies Help  
Enhance Printing  
Success Rate

Easy to use,  
Ready to print

User-Friendly  
Operations for  
Beginners

STEAM  
education  
supported

Combine with mBuild,  
Laserbox to create  
more

makeblock

## Main Features

Reliable &  
High printing  
success rate

New Technologies Help  
Enhance Printing  
Success Rate

Easy to use,  
Ready to print

User-Friendly  
Operations for  
Beginners

STEAM  
education  
supported

Combine with mBuild,  
Laserbox to create  
more



# A leveled bed is a prerequisite for an accurate print

**98%**

Failed print caused by the failure of the first layer printing

**87%**

of them are due to the improper bed leveling/unleveled

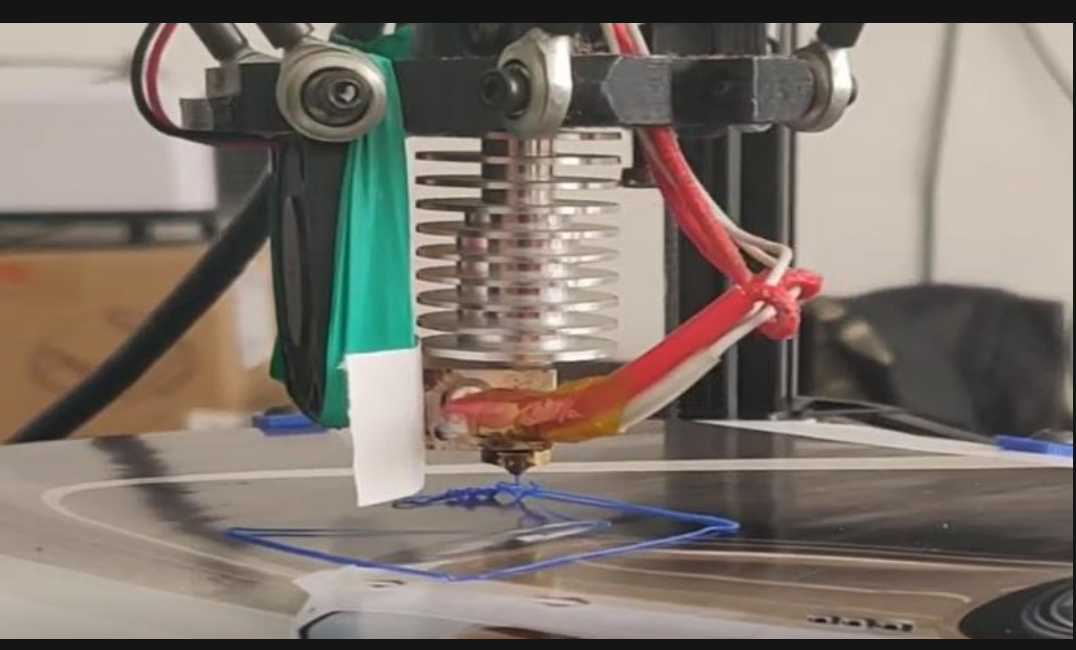
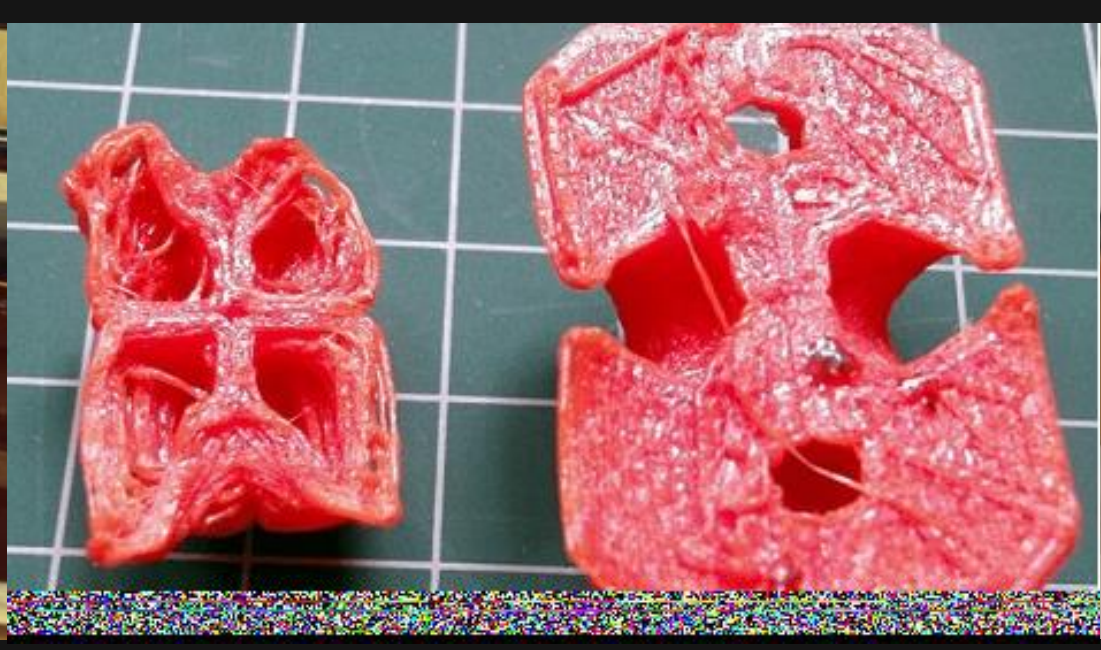
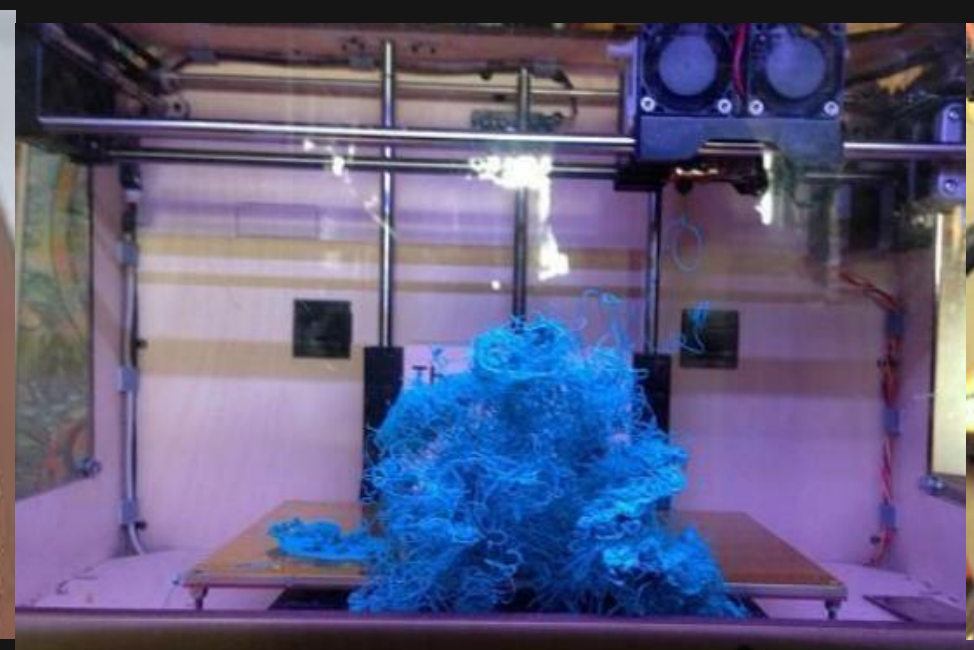



makeblock

## How does other 3D printer do the bed leveling?

### Manual Bed leveling

X complicated and frustrating experience

X a risk of human error

X tedious and time-consuming



[Click to watch the video](#)

## How does other 3D printer do the bed leveling?

### Automatic Bed leveling

X indirect measurement

X mechanical errors, influence the measurement accuracy

3D printer with auto-leveling has a switch or proximity sensor near the tip of the print head that “probes” specific points on the platform when the bed leveling process is first initiated.

makeblock

## Makeblock mCreate

**Genius** smart leveling creates accurate prints

| Avoid errors

| Hassle-free

| Truly guarantee the success rate of the first layer printing



[Click to watch the video](#)



makeblock

# Patented smart nozzle makes printing better and steadier

| AI-enabled sensor, measurement accuracy within 0.01mm

| Integrated extruder, Quick nozzle replacement in 3s

| Ultra-quiet cooling system, a 360-degree circular airflow pattern to enable even cooling for discharge

| Intelligent filament sensor, avoid print failure caused by a material shortage.

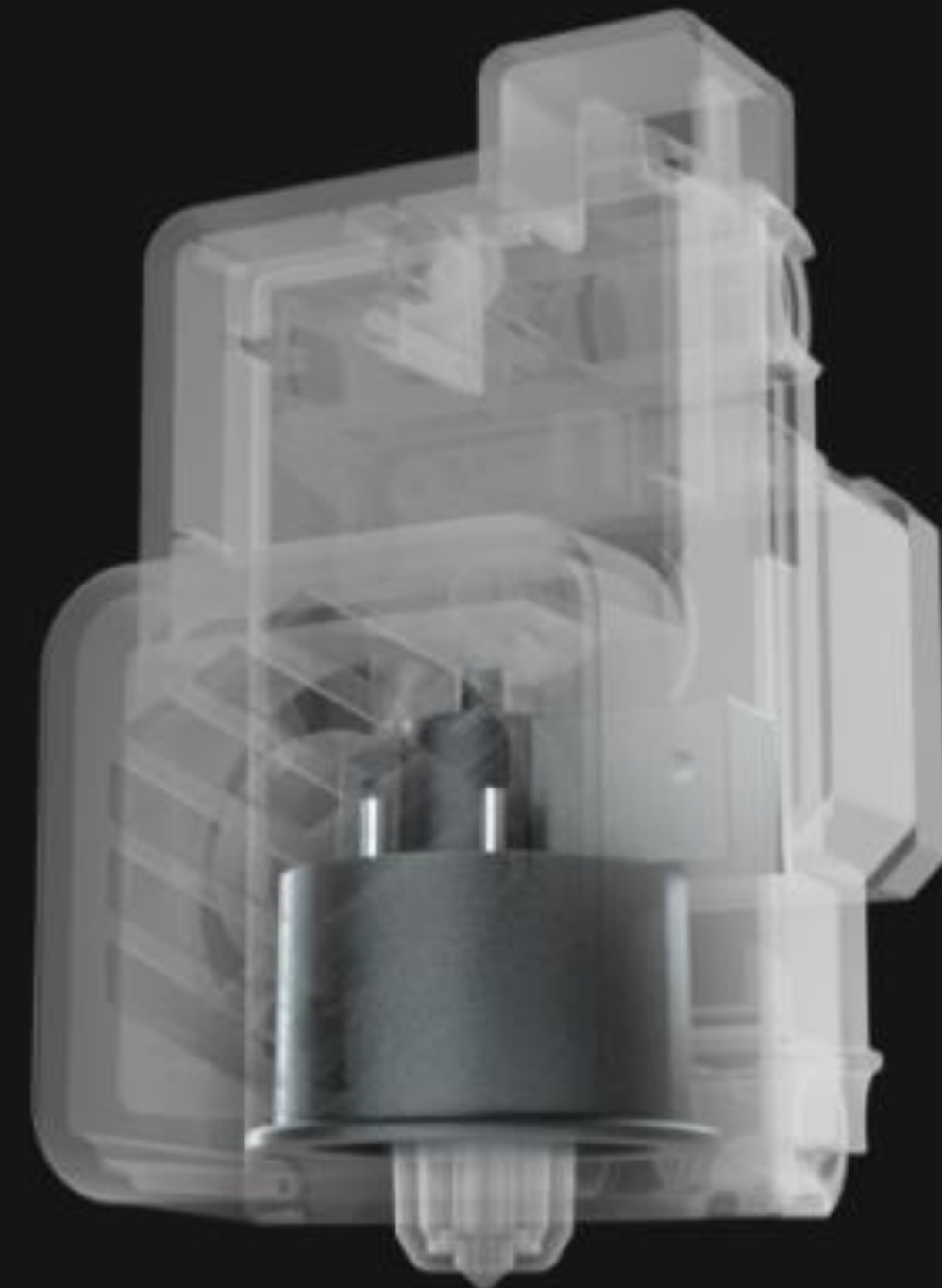

makeblock

# Patented smart nozzle makes printing better and steadier

| AI-enabled sensor, measurement accuracy within 0.01mm

| Integrated extruder, Quick nozzle replacement in 3s

| Ultra-quiet cooling system, a 360-degree circular airflow pattern to enable even cooling for discharge

| Intelligent filament sensor, avoid print failure caused by a material shortage.

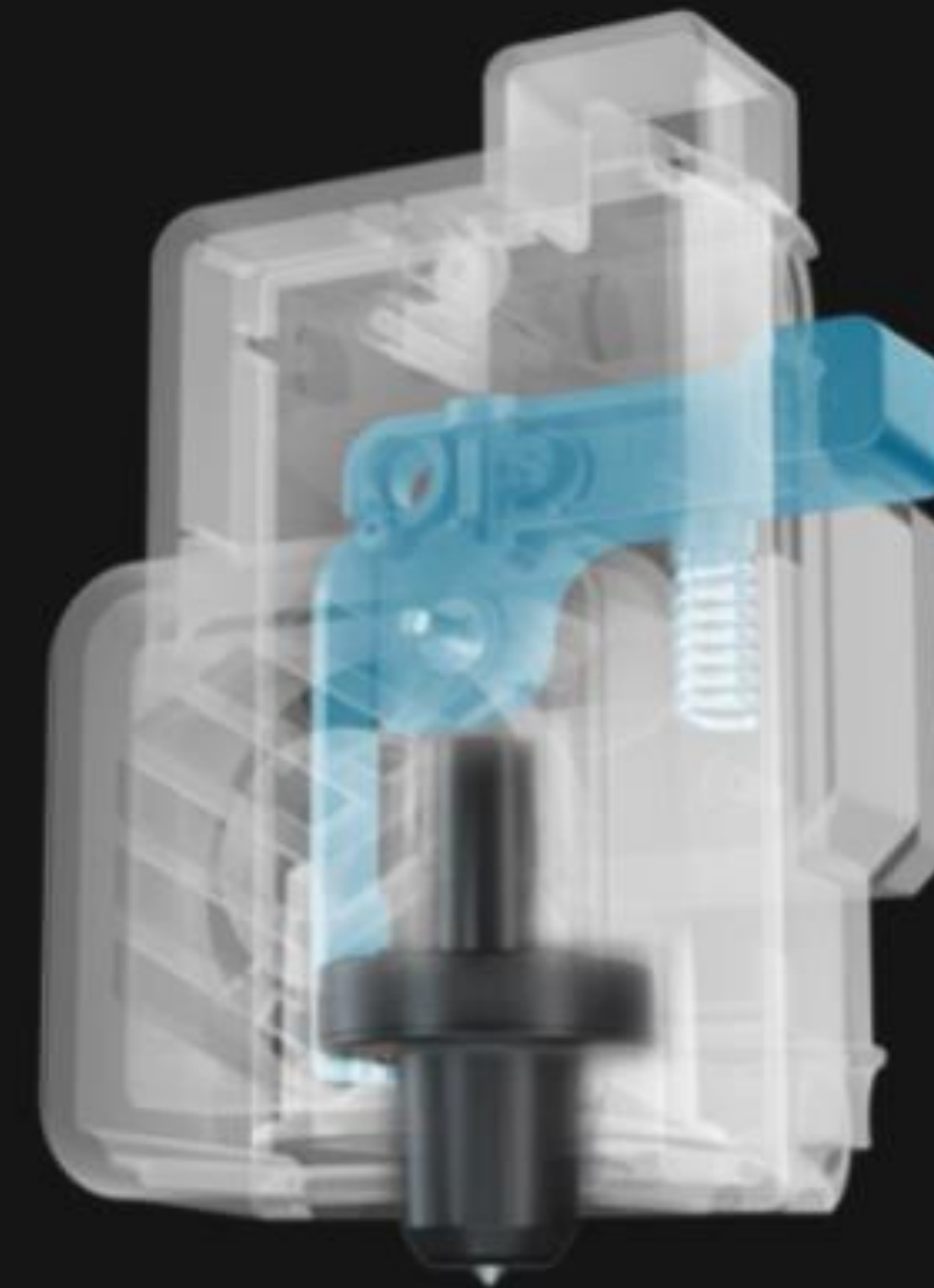

[Click to watch the video](#)

makeblock

# Patented smart nozzle makes printing better and steadier

| AI-enabled sensor, measurement accuracy within 0.01mm

| Integrated extruder, Quick nozzle replacement in 3s

| Ultra-quiet cooling system, a 360-degree circular airflow pattern to enable even cooling for discharge

| Intelligent filament sensor, avoid print failure caused by a material shortage.



[Click to watch the video](#)



makeblock

# Patented smart nozzle makes printing better and steadier

| AI-enabled sensor, measurement accuracy within 0.01mm

| Integrated extruder, Quick nozzle replacement in 3s

| Ultra-quiet cooling system, a 360-degree circular airflow pattern to enable even cooling for discharge

| Intelligent filament sensor, avoid print failure caused by a material shortage.

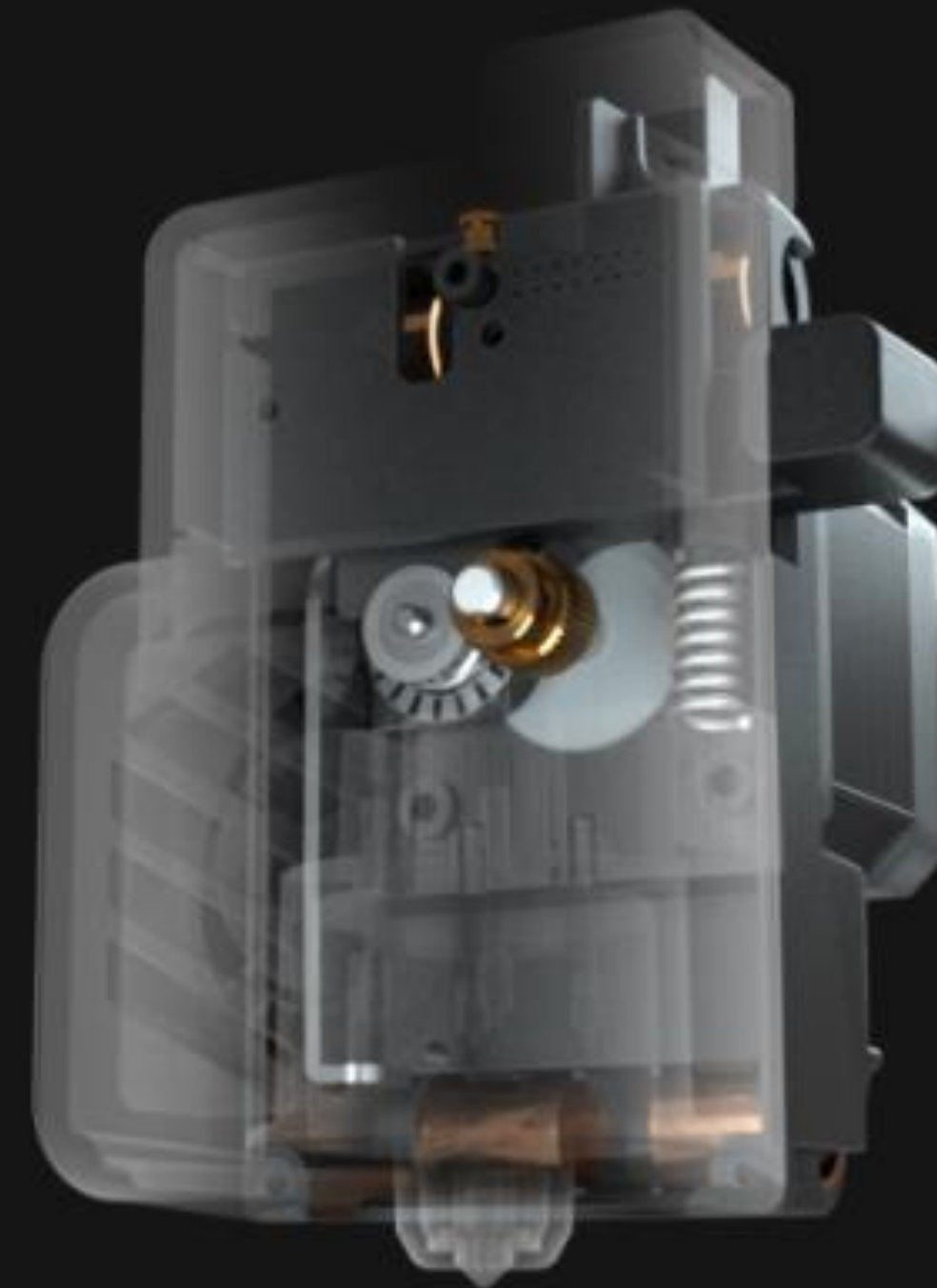

makeblock

## Magnetic flexible printing platform supports various materials and easy pickup of output

| The magnetic cover is heated evenly which enhanced the adhesion of the 3D print as well as preventing edge warping and curling.

| After printing, you can take off the magnetic cover and easily remove the output without needing a scraper.



[Click to watch the video](#)

## Resume printing after a power outage

The nozzle will rise instantly during a power outage, protecting the semi-finished print. After the power is back on, the nozzle will return to its initial position to heat up and then continue printing. This feature effectively minimizes print material and time losses due to power interruptions.

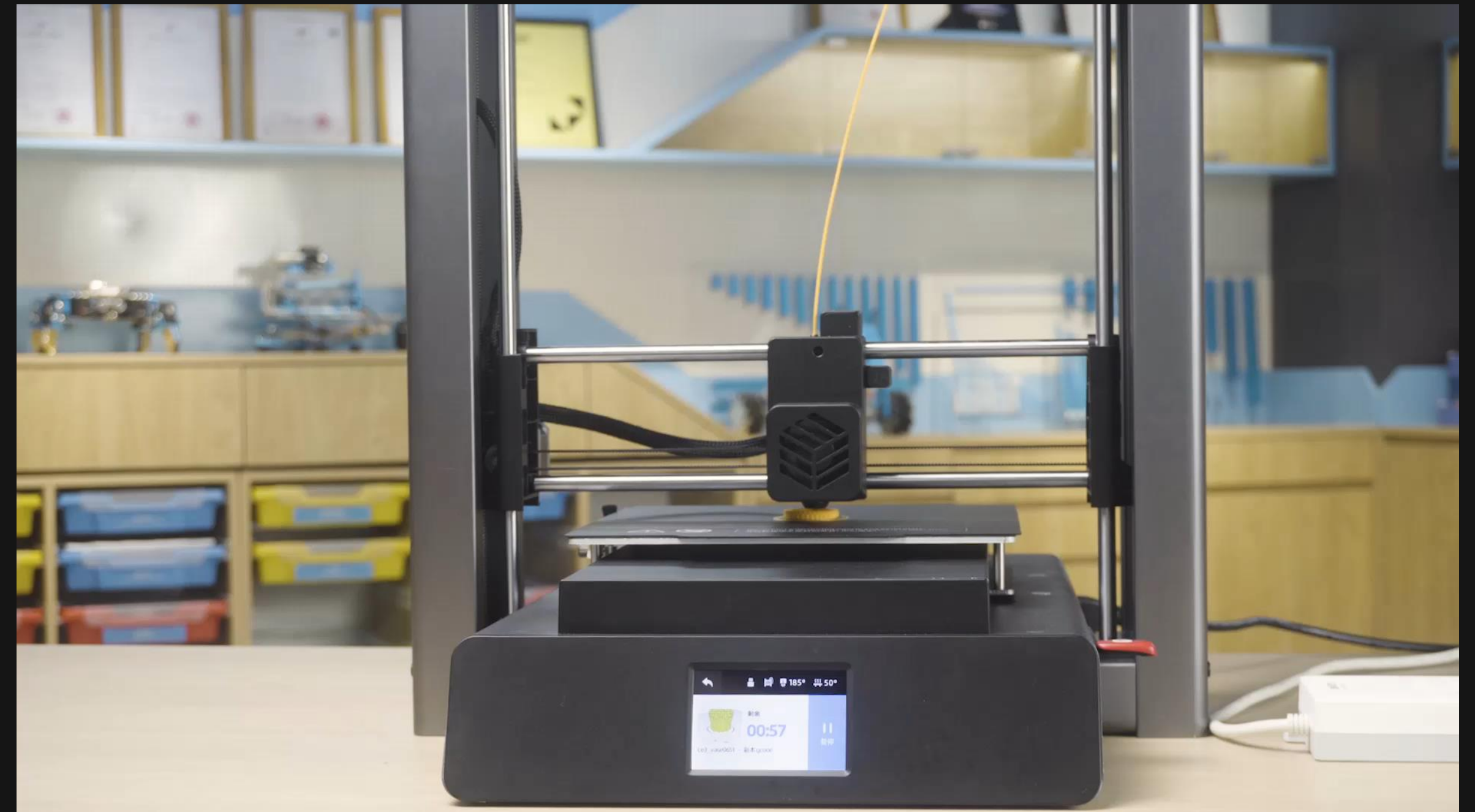

[Click to watch the video](#)



makeblock

# Aircraft-grade aluminum, Improve success rate comprehensively

mCreate has a solid body that minimizes resonance, making printing more stable. The stylish body design is also corrosion-resistant and durable.

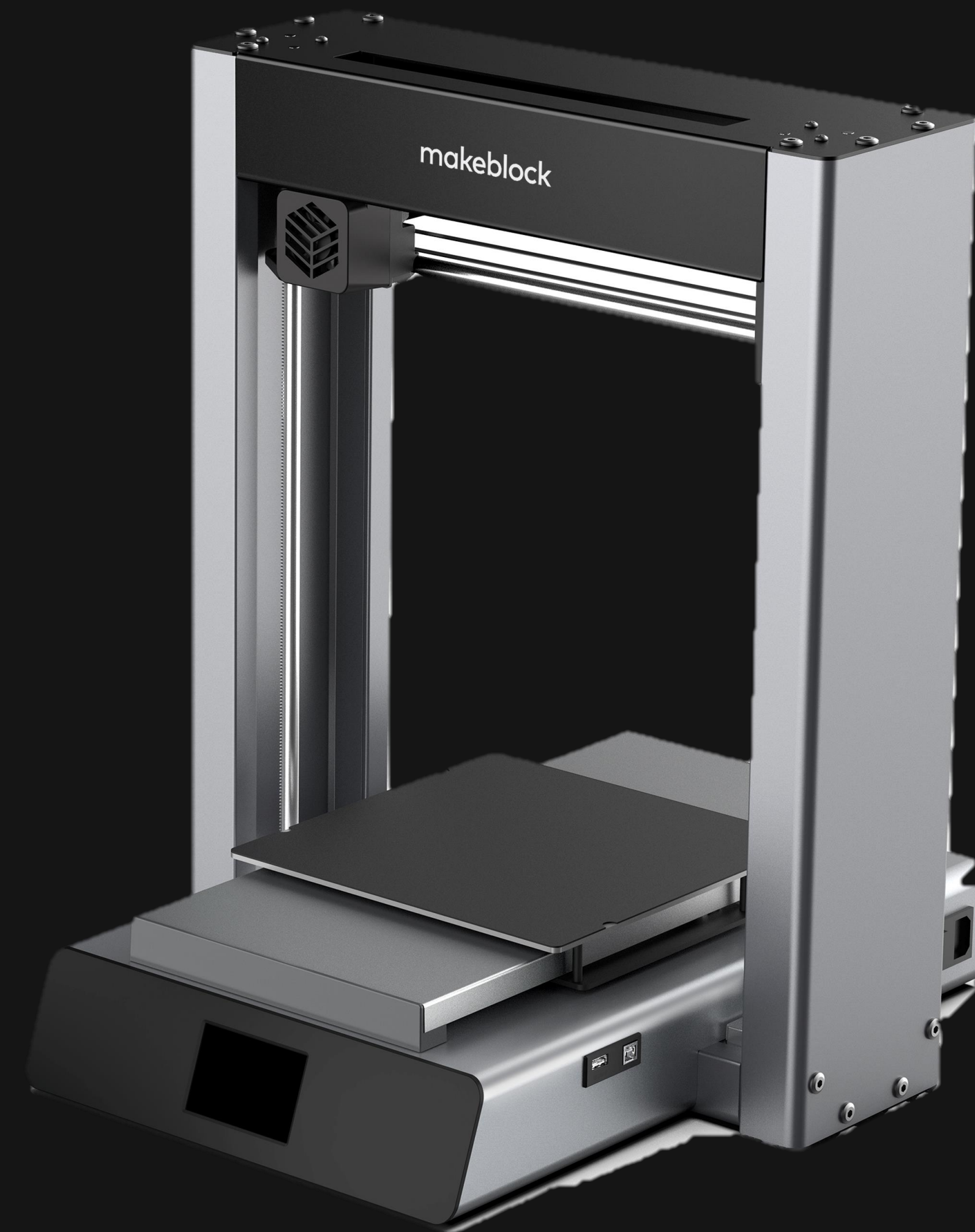

makeblock

# Large Build Volume, expands what is possible to create

mCreate provides a super-sized printing volume that allows you to print multiple models in one go and print the works with high height, serving the needs of large classes.

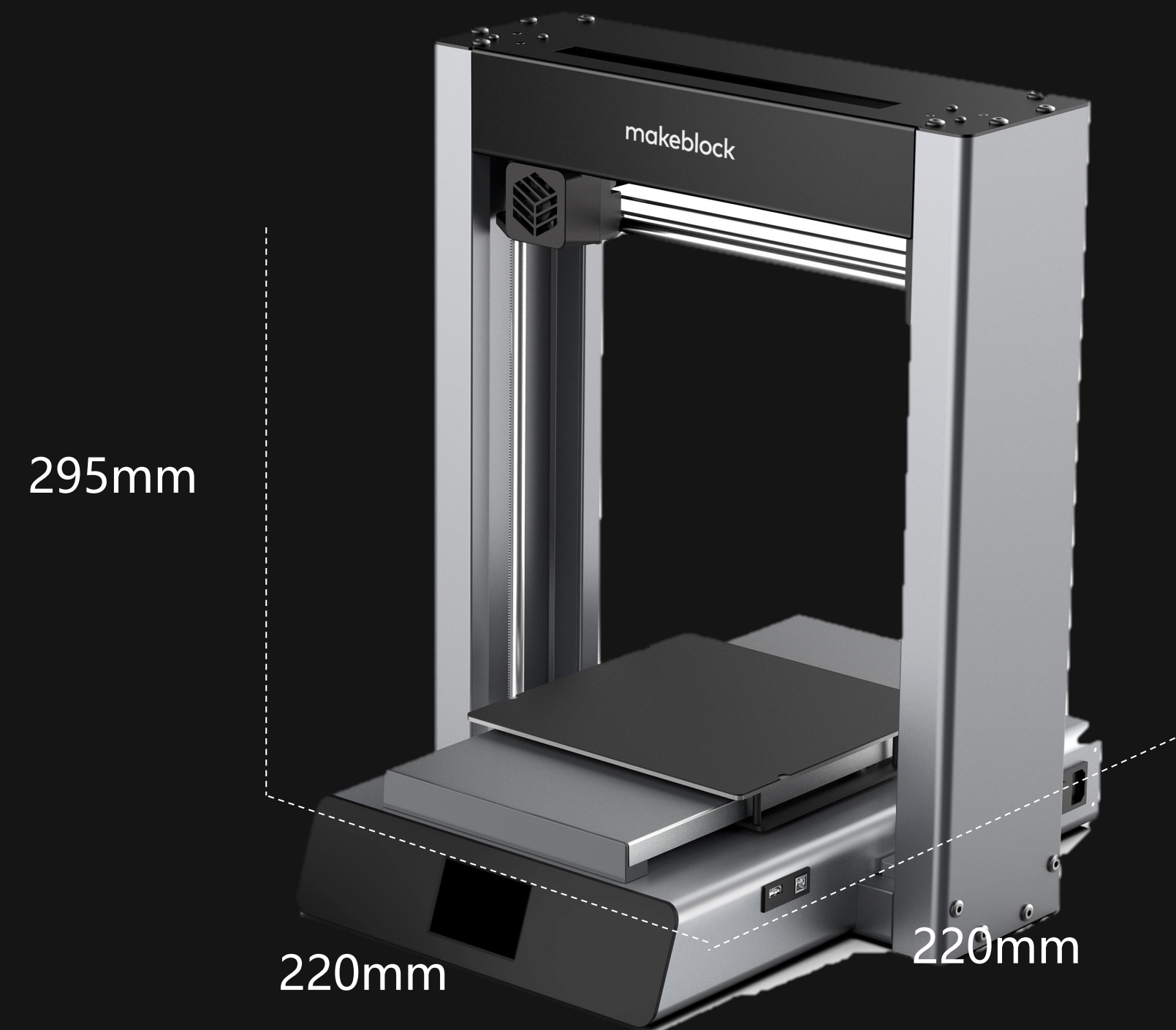

## Main Features

Reliable &  
High printing  
success rate

New Technologies Help  
Enhance Printing  
Success Rate

Easy to use,  
Ready to print

User-Friendly  
Operations for  
Beginners

STEAM  
education  
supported

Combine with mBuild,  
Laserbox to create  
more



makeblock

## Main Features

Reliable &  
high printing  
success rate

New Technologies Help  
Enhance Printing  
Success Rate

Easy to use,  
ready to print

User-Friendly  
Operations for  
Beginners

STEAM  
education  
supported

Combine with mBuild,  
Laserbox to create  
more

makeblock

# Versatile and user-friendly operating tools

## 3D printing

### Preset default slicing value

Run the 3D slicing software called Cura, then install the plug-in for mCreate, and select "Makeblock" as the print device; the printing parameters will then be configured automatically. When Cura finishes slicing your model, it is ready for printing.

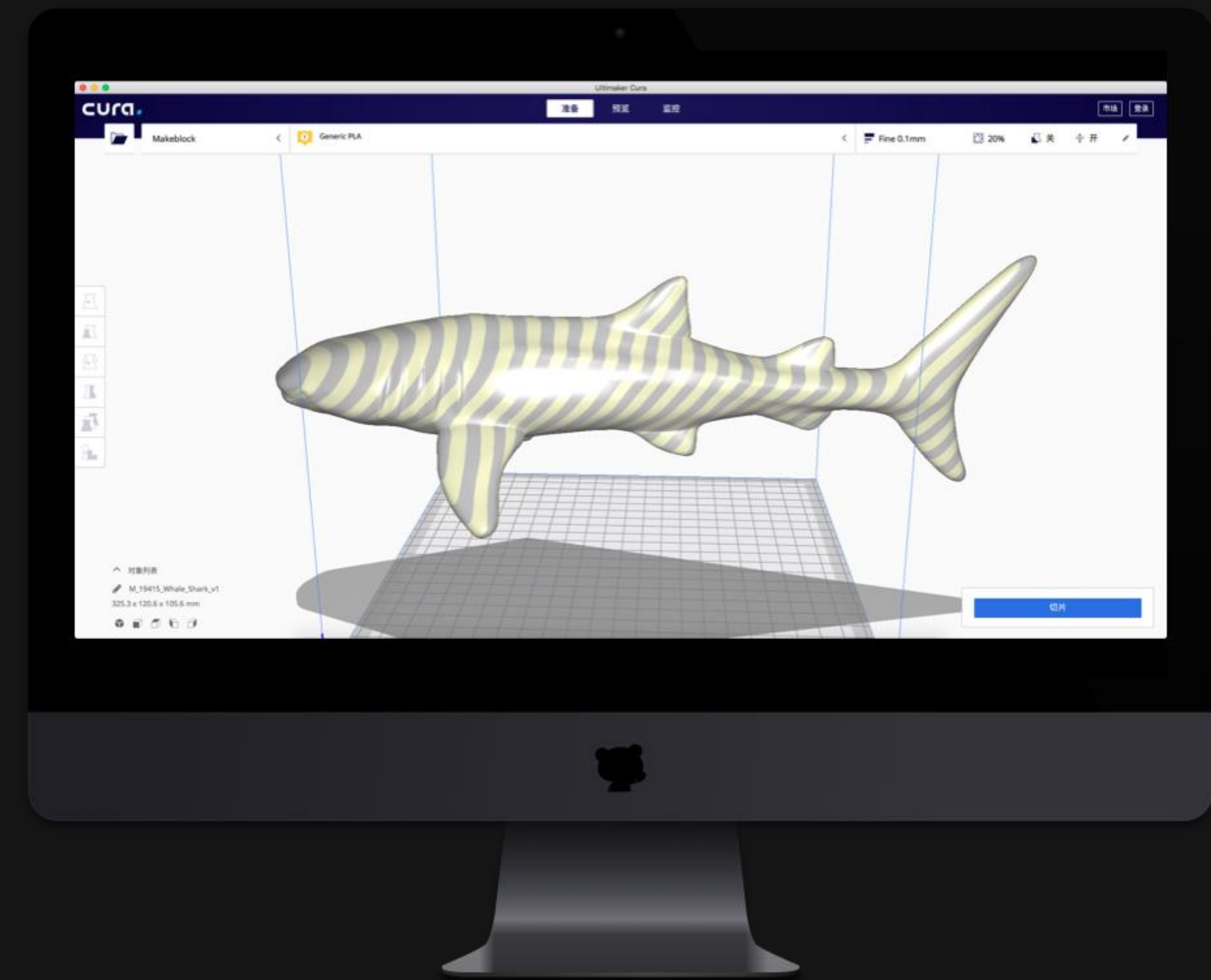

# Full-color touchscreen for better workflow visualization

- 3.5 inch full-color screen
- Clear and intuitive function icons
- Real-time display of device status and job status
- Direct launch of printing jobs or update of firmware
- Support file search and preview
- Default OS languages are English & Chinese yet can be set to two other OS languages





## Main Features

Reliable &  
high printing  
success rate

New Technologies Help  
Enhance Printing  
Success Rate

Easy to use,  
ready to print

User-Friendly  
Operations for  
Beginners

STEAM  
education  
supported

Combine with mBuild,  
Laserbox to create  
more

makeblock

# Integration of hardware and software, designed for education

mCreate helps students learn from their practice on idea materialization and thinking training. With mBuild electronic modules, students can use mCreate to program their creative ideas into smart home prototype designs, robot design and building, etc.

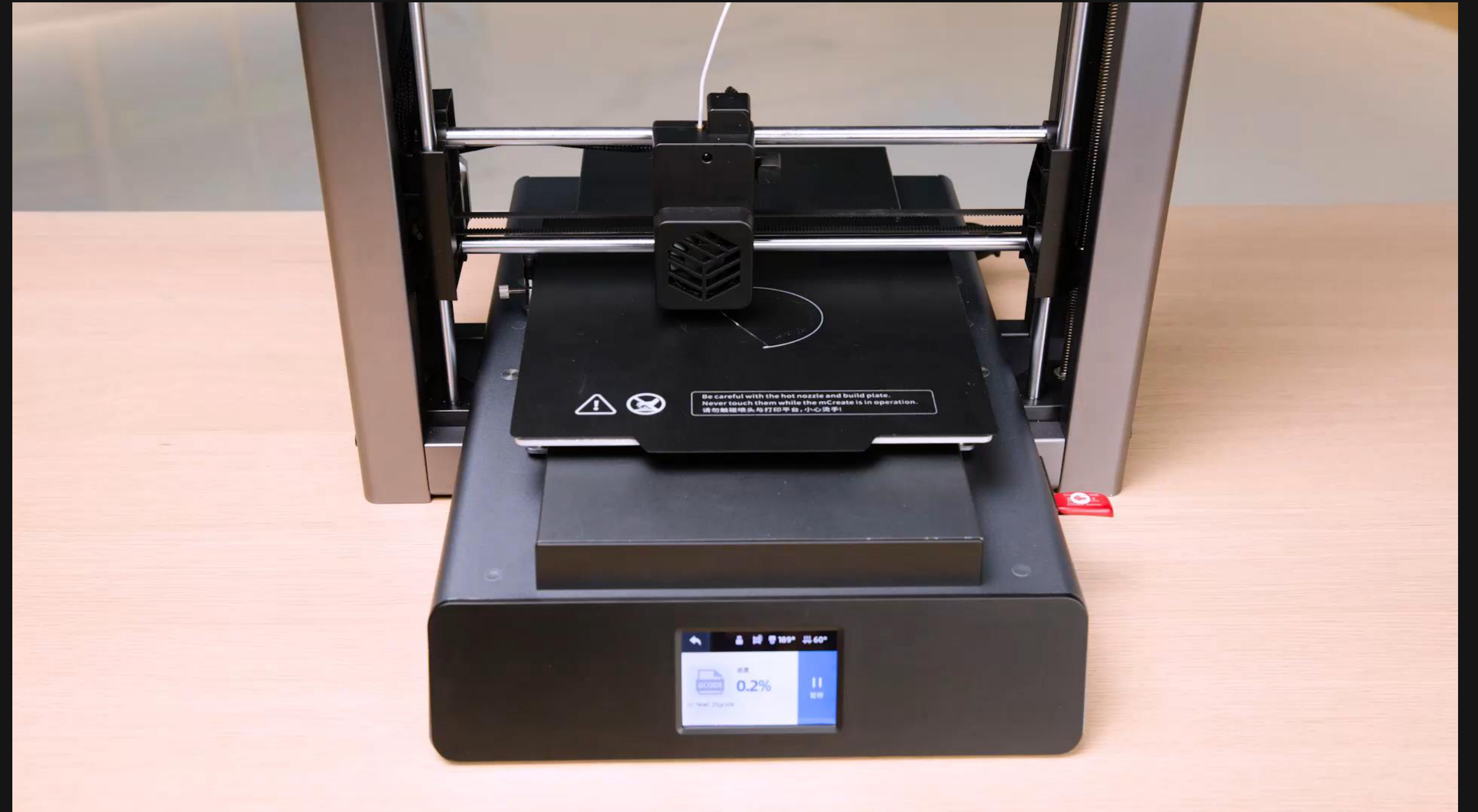

[Click to watch the video](#)



# Other Features



## Clog detection

Check whether the nozzle is clogged.



## Multiple connection modes

Support third-party materials to allow more creative possibilities.

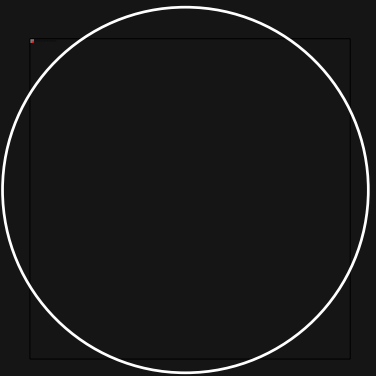

## Open filament system

USB connected to mCreate or a file sent through Cura/Laserbox to mCreate.

# Specification

## 3D printing

Additive Manufacturing Process	FDM
Build Volume (L x W x D)	220 x 220 x 295 mm
Layer Resolution	50-300μm
Software (Slicing Application)	Cura
Supported File Type(s)	STL, OBJ, X3D, 3MF, JPG, PNG, GIF, BMP, etc.
File Extension	GCODE
Supported Materials	PLA and derivatives, ABS and derivatives, TPU, PC, Nylon, PET, ASA, HIPS, PP, PVA, etc
Nozzle Temperature	260°C (Max.)
Heated Bed	100°C (Max.)

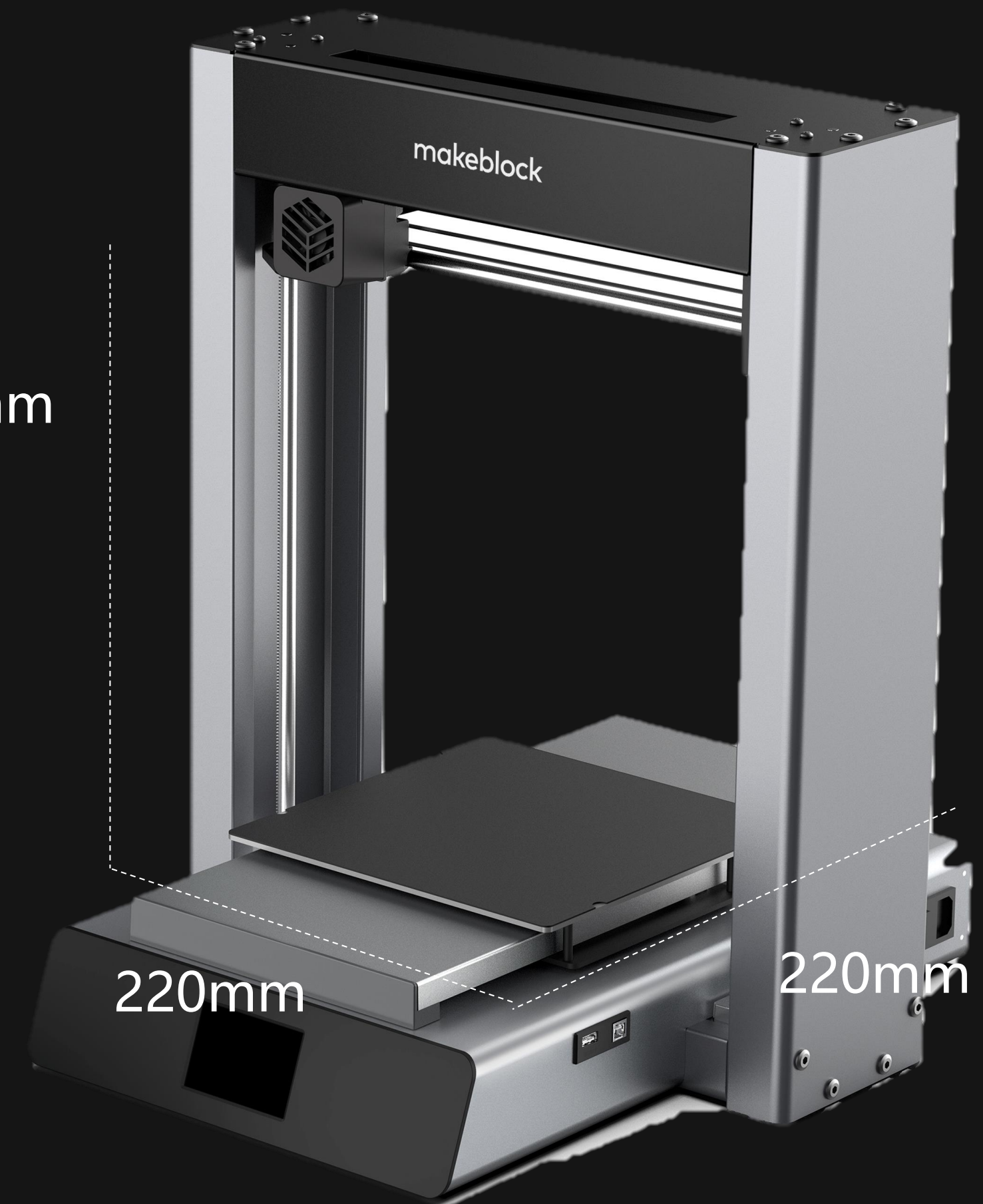







# Makeblock mCreate

Smart leveling versatile 3D printer

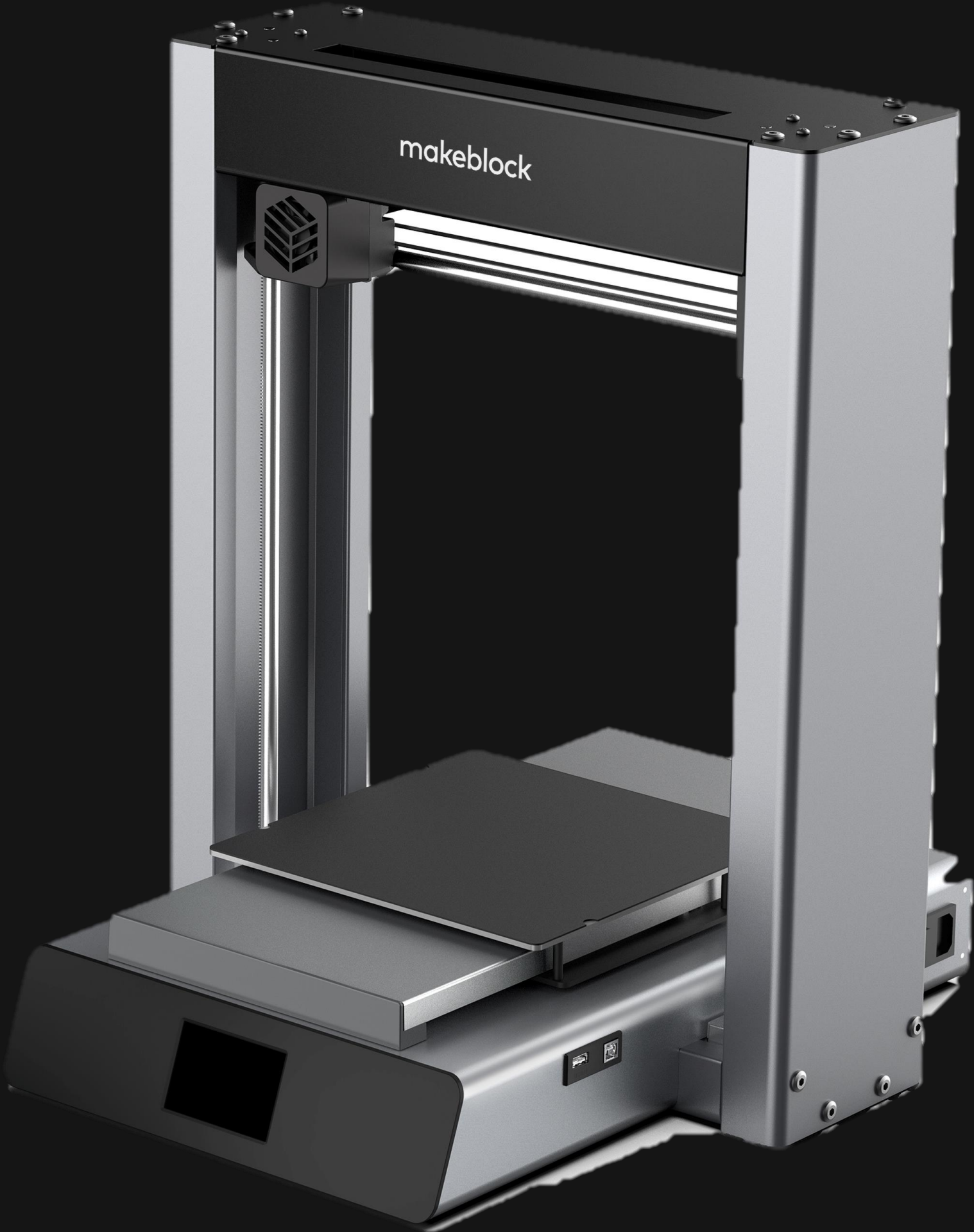
**\$799**  
3D printing only



	XYZprinting da Vinci Jr. 1.0 Pro	Makeblock mCreate	Makeblock Advantages
Picture			Better look, better design
Product Dimension	420 x 430 x 380 mm	445 x 485 x 550 mm	
Type	Close	Open(Shield on the way for close design)	Open&close structure switchable. Open structure can provide better view of the printing process
Printing Technology	Fused filament fabrication	Fused deposition modeling	
Max. Building Size	150 x 150 x 150 mm	220 x 220 x 295 mm	Providing much larger building space at with almost same size
X/Y Positioning Precision	0.0125mm	0.01mm	
Z Positioning Precision	0.0004mm	0.002mm	
Layer Resolution	20-400µm	50-300µm	
Max. Moving Speed	160mm/s	150mm/s	
Filament Diameter	1.75mm	1.75mm	
Material Compatibility	PLA, Antibacterial PLA / PETG / Tough PLA / Wood / *Premium Metallic PLA	PLA and derivatives, TPU, PP, PVA, etc.	
Max. Nozzle Temperature	240°C	260°C	High temperature with high material compatibility

Thanks