



# 1700V 6-pack (3 Phase ) Silicon Carbide Power Module

## GE17045EEA3

$V_{DS}$ : 1700 V  $I_{DS}$ : 425 A

Superior performance for high power, high frequency applications needing best-in-class power density

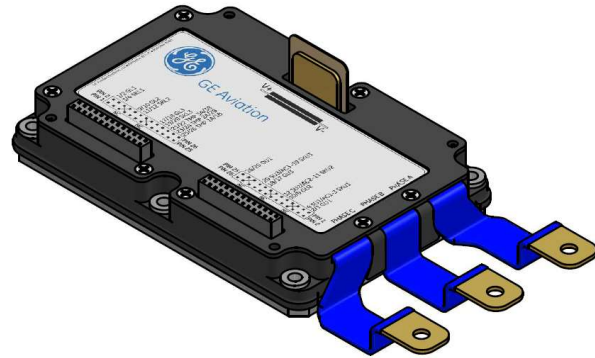

## Features

- Highly reliable GE SiC MOSFET devices
- Low  $R_{DS(ON)}$  (3.75 m $\Omega$ ) (device only)
- Low stray inductance
- Ultra-low switching losses over entire operating range
- Body diode with minimal reverse recovery
- Integrated temperature sensing
- Dedicated DESAT Pin and Source-Kelvin Pin
- AlSiC Baseplate and Si<sub>3</sub>N<sub>4</sub> AMB Substrate

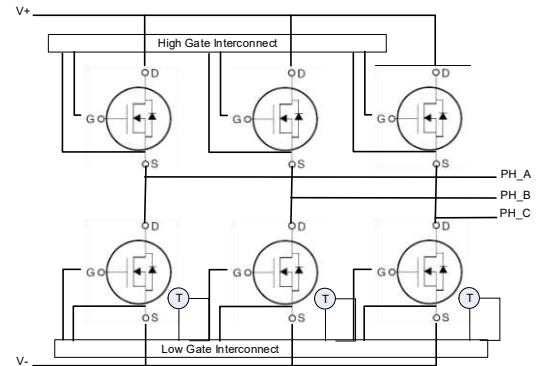

### MOSFET DC Characteristics @ $T_J = 25^\circ\text{C}$ (unless otherwise specified)

Symbols	Parameters	Min.	Typ.	Max.	Unit	Test Conditions	Notes
$I_{DS}$	Continuous Drain Current			425		$V_{GS} = 20\text{ V}, T_c = 25^\circ\text{C}$	Per Switch
				300	A	$V_{GS} = 20\text{ V}, T_c = 100^\circ\text{C}$	
				245		$V_{GS} = 20\text{ V}, T_c = 125^\circ\text{C}$	
$I_{DS,pulse}$	Pulsed Drain Current			850	A	$T_c = 25^\circ\text{C}, t_p = 1\text{ ms}$	
$V_{DSmax}$	Drain - Source Breakdown Voltage	1700			V	$V_{GS} = 0\text{ V}, I_{DS} = 100\ \mu\text{A}$	
$V_{GSmax}$	Maximum Gate - Source Voltage			-15/+23	V	$V_{DS} = 0\text{ V}$	
$V_{GSop}$	Recommended Gate - Source Voltage		-5/+20		V		
$T_{Jmax}$	Junction Temperature			175	$^\circ\text{C}$		
$T_c$	Case Temperature Range	-55		150	$^\circ\text{C}$		
$T_{STG}$	Storage Temperature Range	-55		150	$^\circ\text{C}$		
$P_D$	Power Dissipation			1250	W	$T_c = 25^\circ\text{C}$	



(Continued) **MOSFET DC Characteristics @  $T_J = 25^\circ\text{C}$**  (unless otherwise specified)

Symbols	Parameters	Min.	Typ.	Max.	Unit	Test Conditions	Notes
$I_{DS}$	Continuous Drain Current			425	A	$V_{GS} = 20\text{ V}, T_c = 25^\circ\text{C}$	Per Switch
$V_{GS(th)}$	Gate Threshold Voltage	2.5	2.9	4.5	V	$V_{GS} = V_{DS}, I_{DS} = 160\text{ mA}$	
$I_{DSS}$	Drain Leakage Current			0.10 1.6	mA	$V_{DS} = 1700\text{ V}, V_{GS} = 0\text{ V}, T_J = 25^\circ\text{C}$ $T_J = 175^\circ\text{C}$	
$I_{GSS}$	Gate-Source Leakage Current			160	nA	$V_{GS} = -15/+23\text{ V}$	
$R_{DS(on)}$	On State Resistance (Device Only)		3.75 6.70	4.45 8.25	m $\Omega$	$V_{GS} = 20\text{ V}, I_{DS} = 425\text{ A}, T_J = 25^\circ\text{C}$ $T_J = 175^\circ\text{C}$	Per Switch
$R_{G(int)}$	Gate-Source Series Resistance		1.4		$\Omega$	$V_{GS} = 0\text{ V}, f = 100\text{ kHz}, T_c = 25^\circ\text{C}$	

**MOSFET Dynamic Characteristics per switch @  $T_J = 25^\circ\text{C}$**  (unless otherwise specified)

Symbols	Parameters	Min.	Typ.	Max.	Unit	Test Conditions	Notes
$C_{iss}$	Input Capacitance		29.10		nF		
$C_{oss}$	Output Capacitance		1.08		nF	$V_{GS} = 0\text{ V}$ $V_{DS} = 900\text{ V}$	
$C_{rss}$	Reverse Transfer Capacitance		0.08		nF	$f = 100\text{ kHz}$	
$E_{on}$	Turn-On Switching Energy		9.1		mJ		
$E_{off}$	Turn-Off Switching Energy		8.6		mJ	$V_{GS} = -8\text{ V to } +20\text{ V}$ $V_{DS} = 900\text{ V}$	
$t_r$	Rise Time		28		ns	$I_{DS} = 425\text{ A}$	
$t_f$	Fall Time		36		ns	$R_{Gon} = R_{Goff} = 1.0\ \Omega$	
$Q_G$	Total Gate Charge		1207		nC	$V_{GS} = 0\text{ to } 18\text{ V}$	
$Q_{GD}$	Gate-Drain Charge		525		nC	$V_{DS} = 900\text{ V}$	
$Q_{GS}$	Gate-Source Charge		186		nC	$I_{DS} = 240\text{ A}$	

**Body Diode Characteristics per switch @  $T_J = 25^\circ\text{C}$**  (unless otherwise specified)

Symbols	Parameters	Min.	Typ.	Max.	Unit	Test Conditions	Notes
$I_{SD}$	Pulsed body diode current			720	A	$V_{GS} = 0\text{ V}$	1.
$V_{SD}$	Diode Forward Voltage		4.65		V	$V_{GS} = 0\text{ V}, I_{SD} = 425\text{ A}, T_J = 25^\circ\text{C}$	

1. Use of body diode is recommended in pulse mode only

**Thermal Characteristics**

Symbols	Parameters	Min.	Typ.	Max.	Unit	Test Conditions	Notes
$R_{th}$	Thermal Resistance Junction-to-Case		0.10	0.12	$^\circ\text{C/W}$	JESD51-14	Per Switch



## Temperature Sensor Characteristics

Symbols	Parameters	Min.	Typ.	Max.	Unit	Test Conditions	Notes
$R_{RTD}$	Rated Resistance of RTD		1k		ohm		2.
	Tolerance of Resistance		0.12		%		
	Accuracy		0.3		°C		
	Measuring Current	100		300	μA		
TCR	Temperature Coefficient		3850		ppm/K		
	Operating Temperature	-70		+500	°C		
	Insulation Resistance		100		MOhm	20°C	

2. RTD is mounted directly over center-most die allowing direct reading of  $T_j$

## Module packaging data

Symbols	Parameters	Min.	Typ.	Max.	Unit	Test Conditions	Notes	
$V_{Iso}$	Case Isolation Voltage	4			kV	AC 50 Hz, 1 min, 25°C		
CTI	Comparative Tracking Index		600					
$M_s$	Mounting Torque			5.0	N-m	Power Terminals		
				4.0		Baseplate		
$L_{V+/V-}$	Loop Inductance		4.0		nH			
	Module Mass		0.54		Kg			
	Clearance Distance		19		mm	Phase A to Phase B		
			19		mm	Phase B to Phase C		
				7		mm	V+ to V-	
				111		mm	V- to Phase A	
				36		mm	Phase B to Baseplate	
				25		mm	V+ to Baseplate	
	Creepage Distance		107		mm	Phase A to Phase B		
				113		mm	Phase B to Phase C	
				7		mm	V+ to V-	
				116		mm	V- to Phase A	
				70		mm	Phase B to Baseplate	
				31		mm	V+ to Baseplate	
$M_{BP}$	Base Plate Material		AlSiC					



Typical performance: **GE17045EEA3**

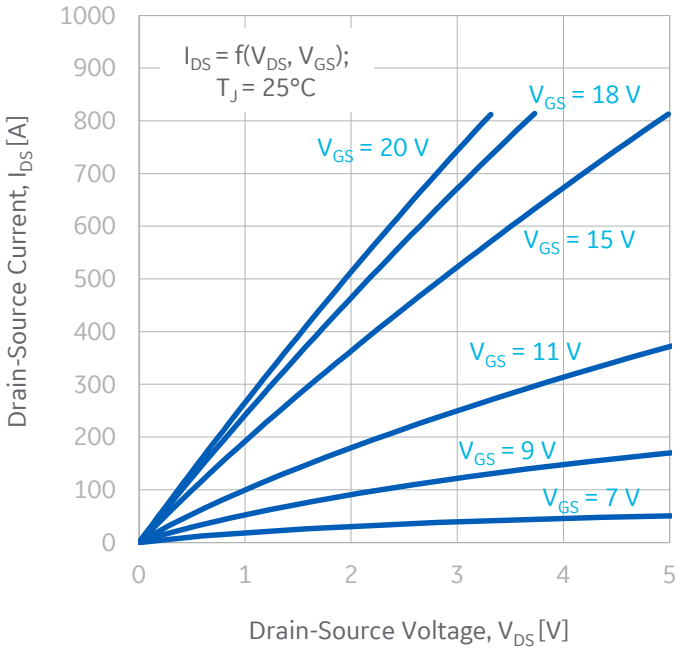

**Figure 1:** Output Characteristics (25°C)

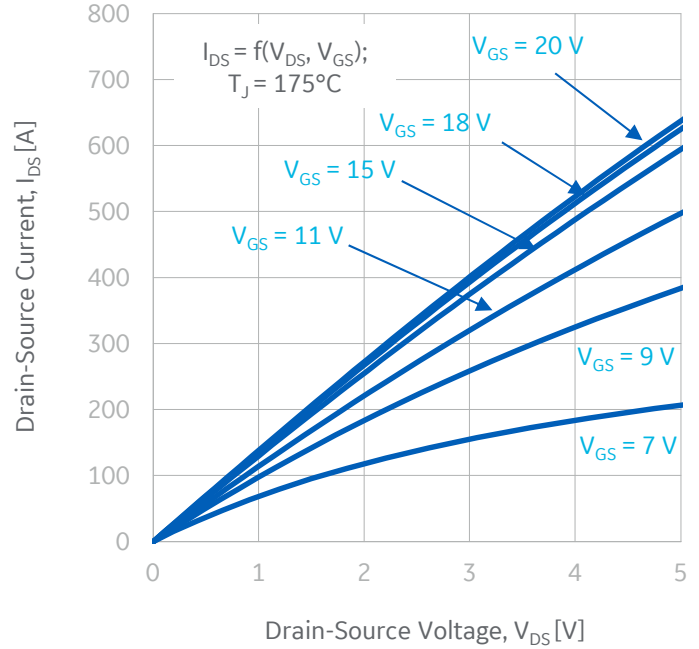

**Figure 2:** Output Characteristics (175°C)

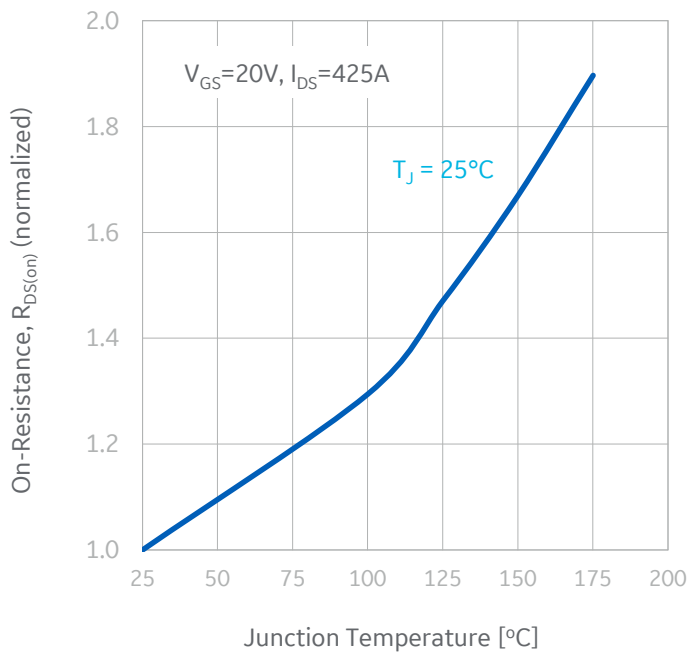

**Figure 3:** Normalized On-state Resistance vs. Temperature

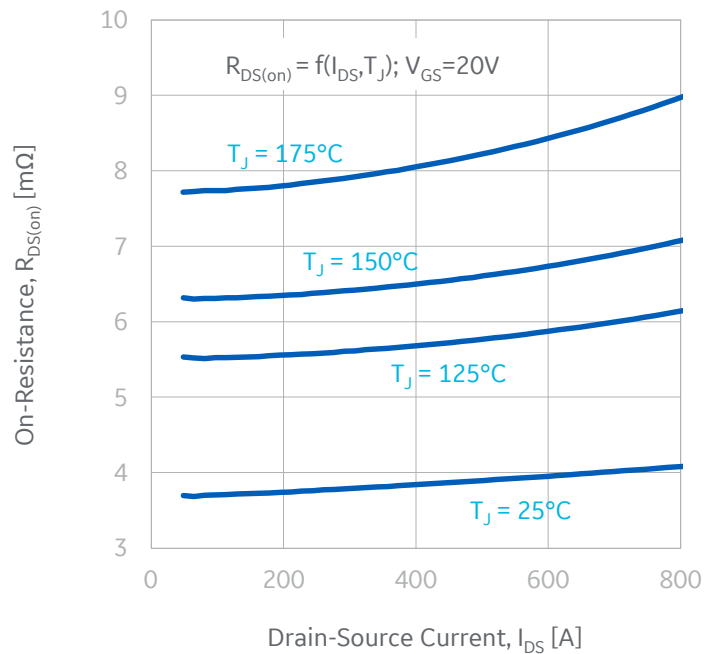

**Figure 4:** Module Drain-Source On-state Resistance



Typical performance: **GE17045EEA3**

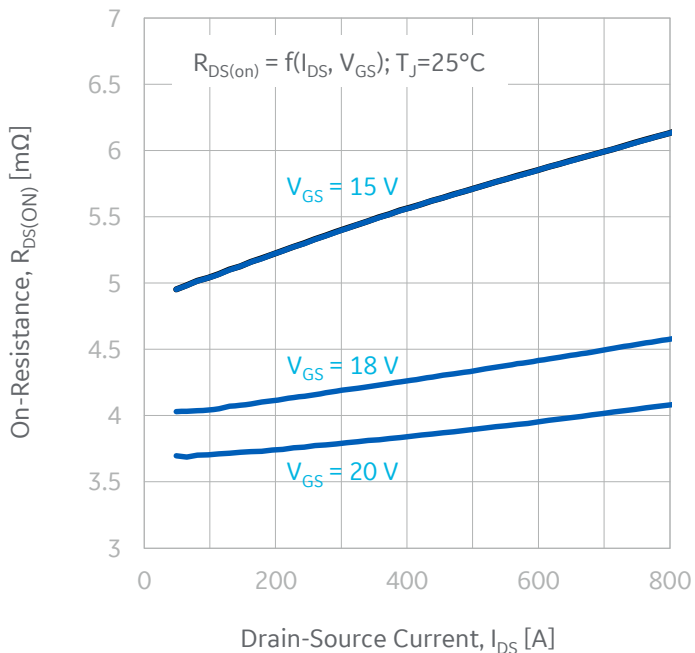

**Figure 5:** Module Drain-Source On-state Resistance

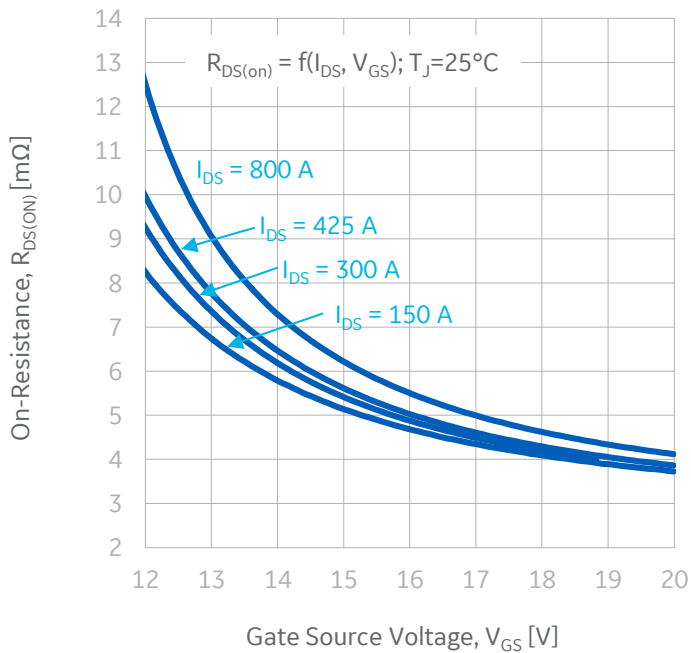

**Figure 6:** Drain-Source On-state Resistance vs. Gate Voltage

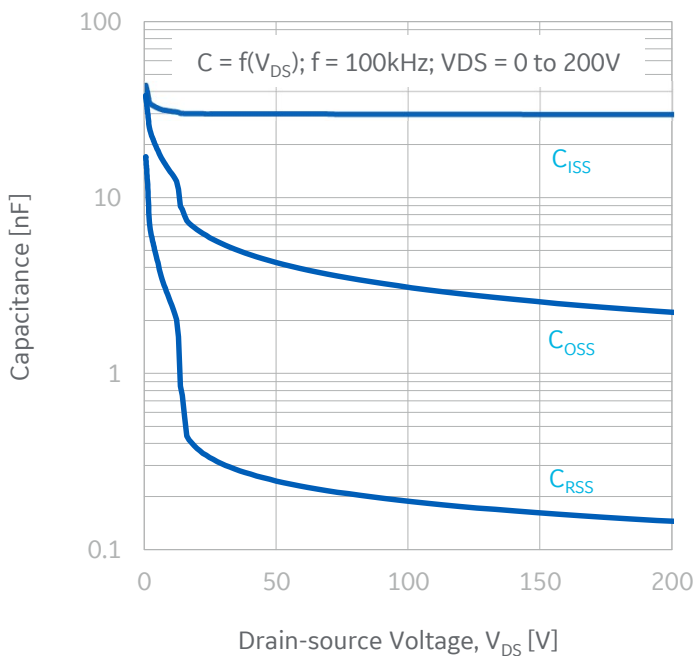

**Figure 7:** Junction Capacitances to 200 V

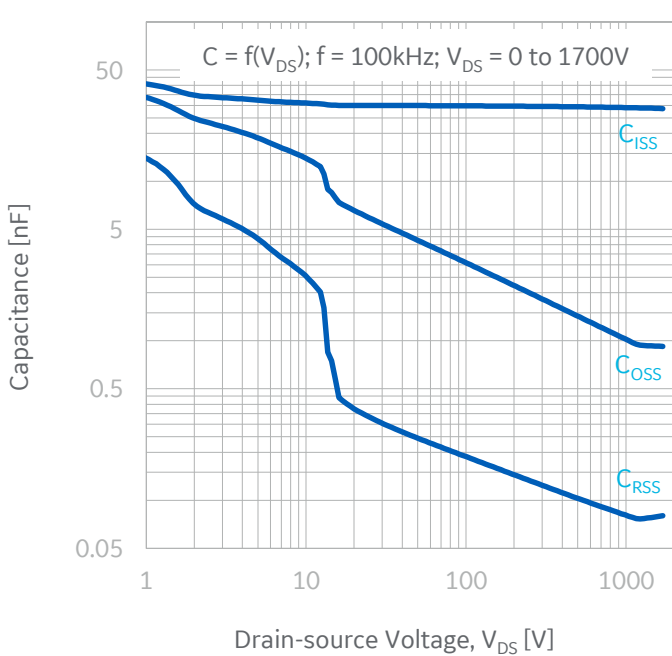

**Figure 8:** Junction Capacitances to 1700 V



Typical performance: **GE17045EEA3**

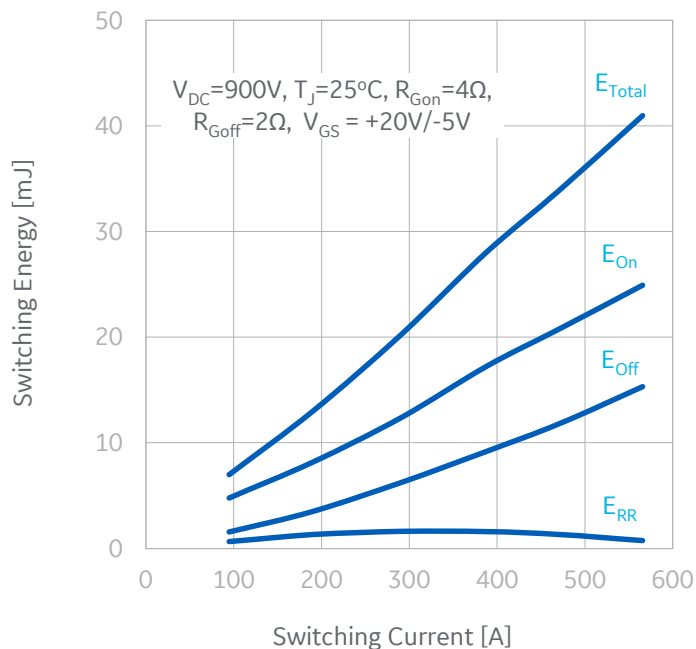

**Figure 9:** Switching Energy vs. Drain Current (900 V)

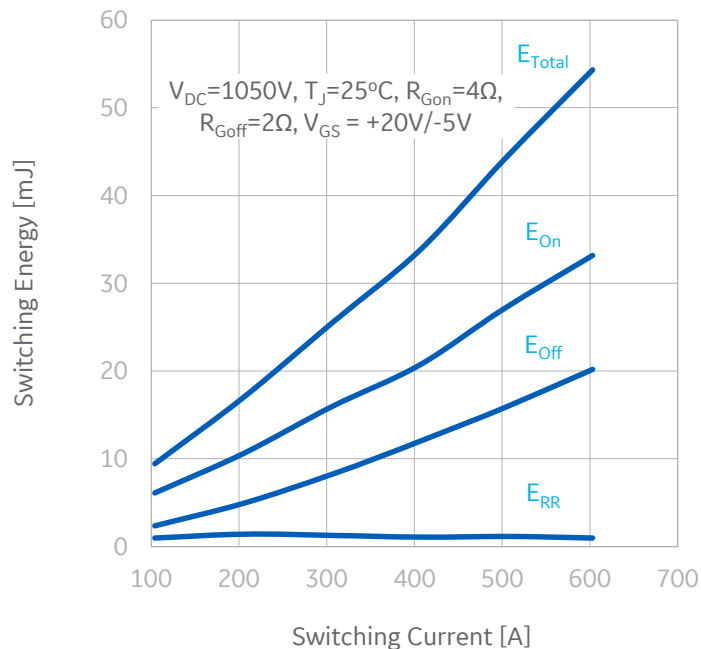

**Figure 10:** Switching Energy vs. Drain Current (1050 V)

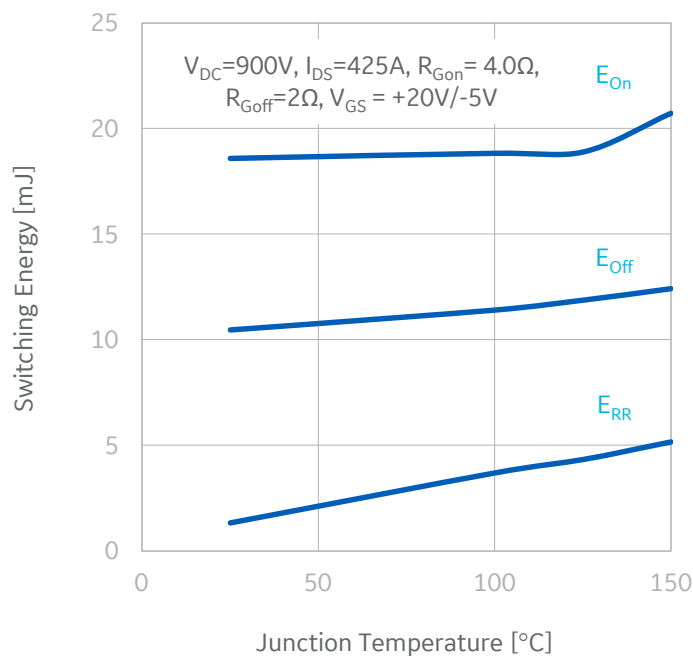

**Figure 11:** Switching Energy vs. Junction Temperature

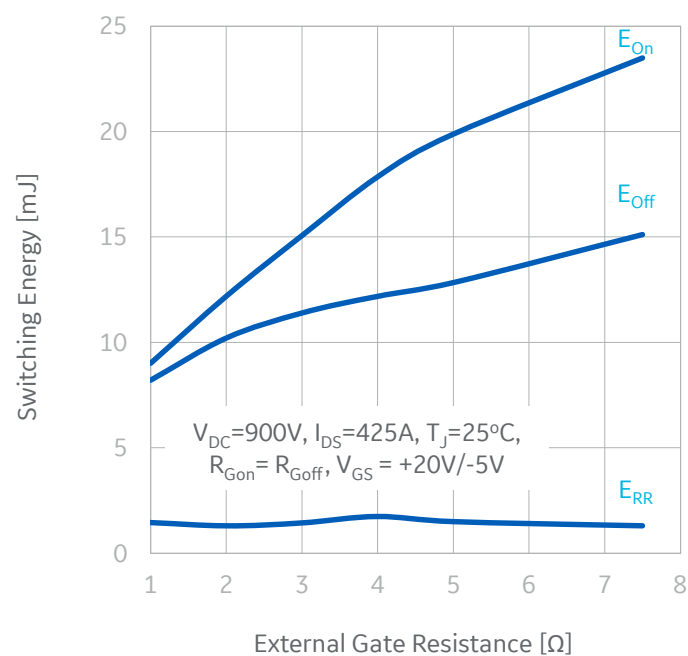

**Figure 12:** Switching Energy vs. Gate Resistance



Typical performance: **GE17045EEA3**

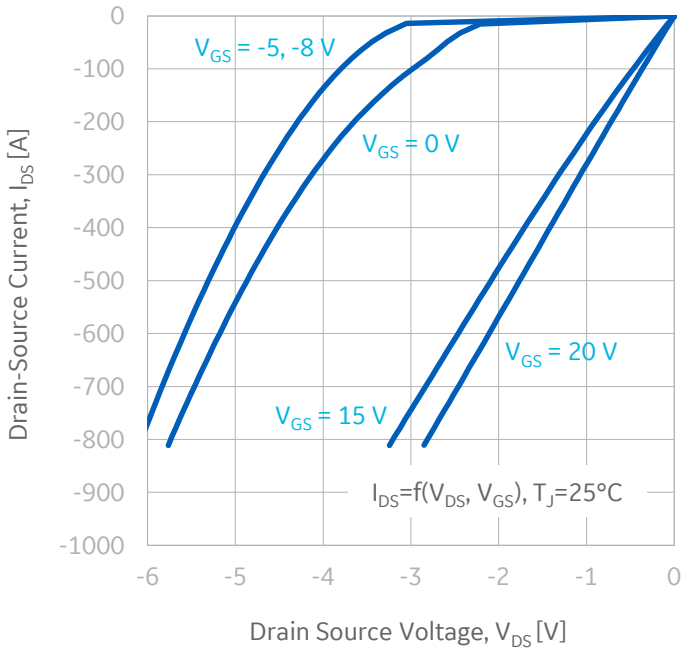

**Figure 13:** 3<sup>rd</sup> Quadrant Characteristics (25°C)

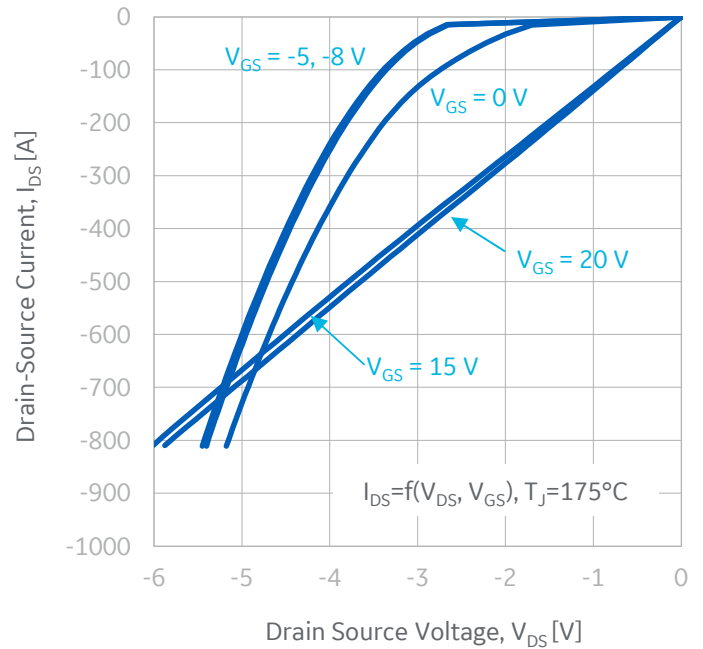

**Figure 14:** 3<sup>rd</sup> Quadrant Characteristics (175°C)

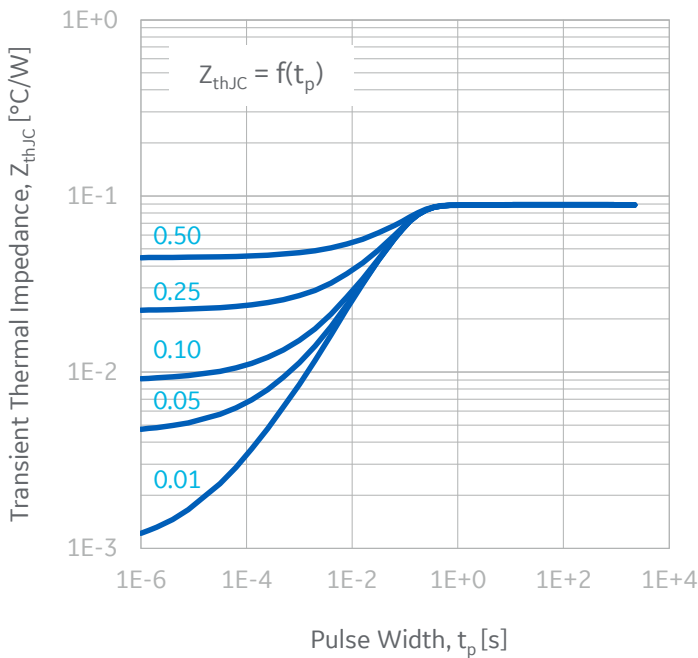

**Figure 15:** Transient Thermal Impedance

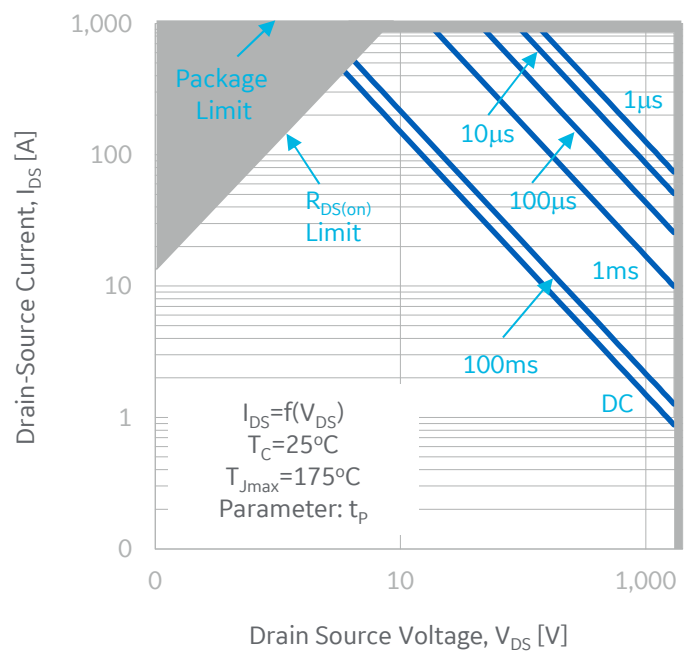

**Figure 16:** Forward-Bias Safe Operating Area



Typical performance: **GE17045EEA3**

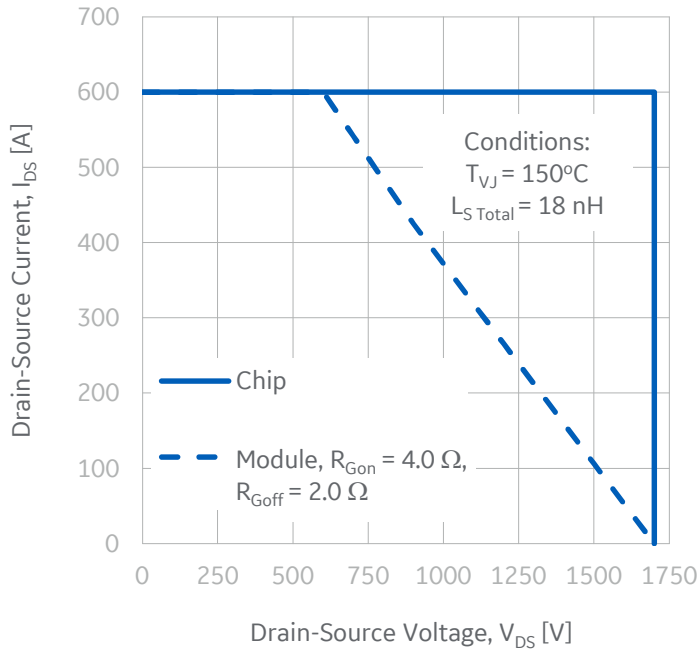

**Figure 17:** Reverse-Bias Safe Operating Area

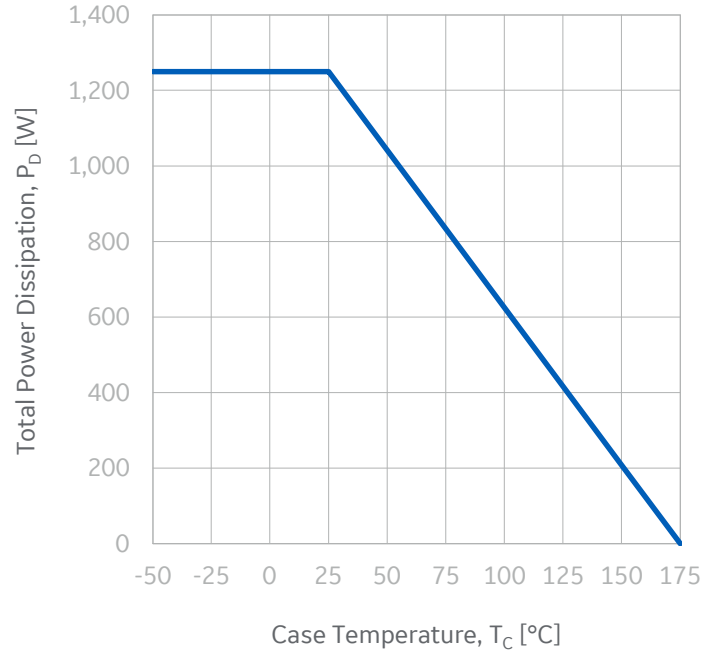

**Figure 18:** Maximum Power Dissipation vs. Case Temperature



# PRELIMINARY



## Module dimensions (millimeters)

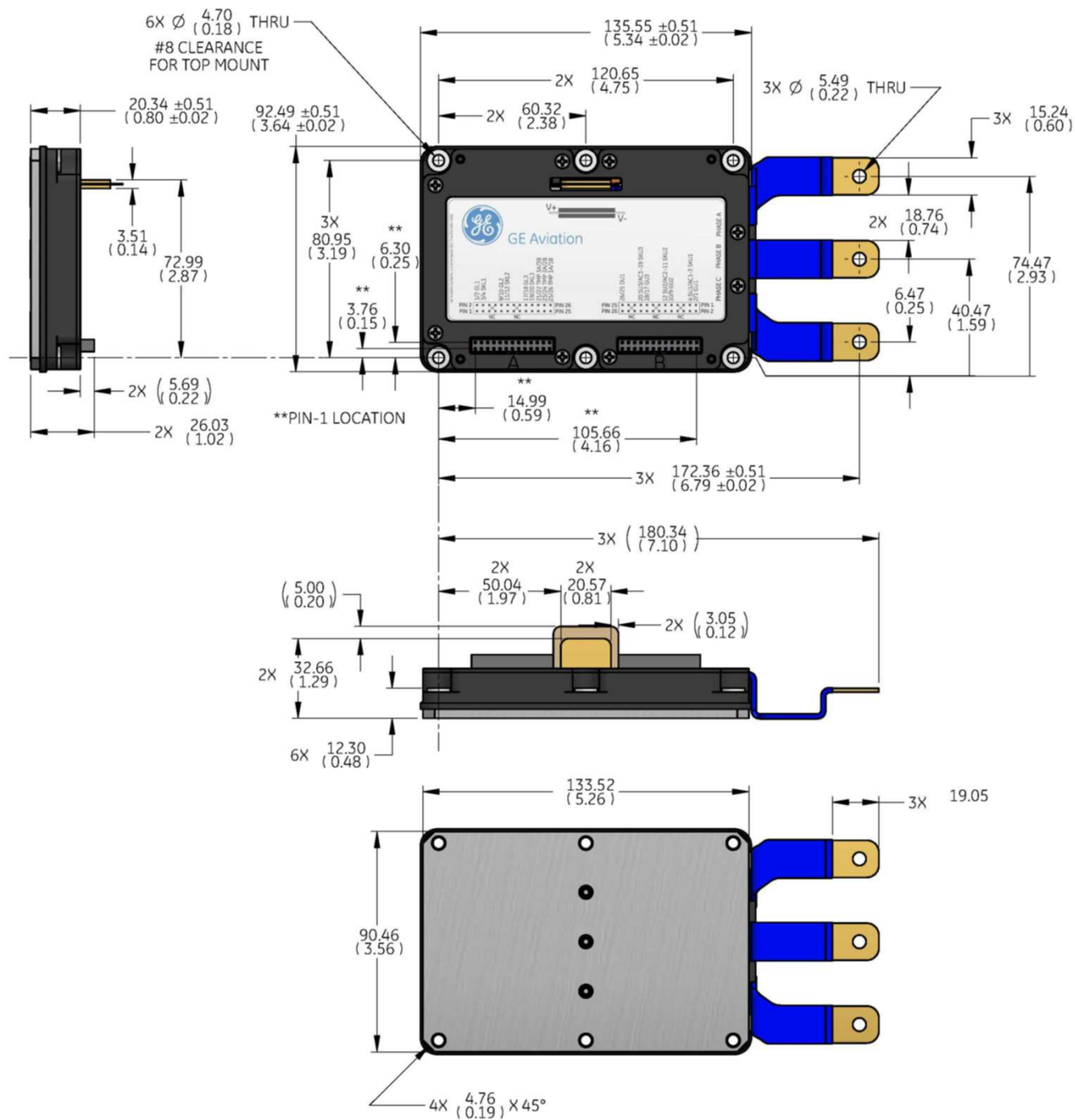



Electrical interface outline drawing

Lower Switch Interconnect	
1	GL1
2	GL1
3	SKL1
4	SKL1
5	**
6	**
7	**
8	**
9	GL2
10	GL2
11	SKL2
12	SKL2
13	**
14	**
15	**
16	**
17	GL3
18	GL3
19	SKL3
20	SKL3
21	TMP3A
22	TMP3B
23	TMP2A
24	TMP2B
25	TMP1A
26	TMP1B

\*\* = No Connection

Upper Switch Interconnect	
1	GL1
2	GL1
3	SKL1
4	SU1/AC1
5	**
6	**
7	**
8	**
9	GL2
10	GL2
11	SKL2
12	SU2/AC2
13	**
14	**
15	**
16	**
17	GL3
18	GL3
19	SKL3
20	SU3/AC3
21	**
22	**
23	**
24	**
25	DU1
26	DU1

\*\* = No Connection

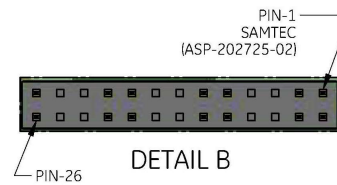
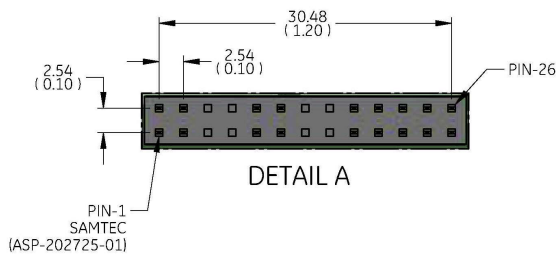

**Disclaimer**

The data presented in this document are for informational purposes only and shall in no event be regarded as a guarantee of conditions or characteristics. Any warranty or license for this product shall be specified and governed by the terms of a separate purchase agreement. General Electric Company does not assume any liability arising out of the application or use of this product; neither does it convey any license under its patent rights, nor the rights of others.

General Electric Company reserves the right to make changes in specifications and features shown herein to improve reliability, function, or design, or discontinue this product, at any time without notice or obligation. Contact your GE representative for the most current information.

**Warning**

This product is not authorized for use (1) in life support systems or (2) for applications implanted into the human body, without the express written approval of General Electric Company.

Questions or need help designing in GE SiC Power modules? Please contact:

[SiC.Products@ge.com](mailto:SiC.Products@ge.com)

GE Aviation  
 2705 Gateway Dr.  
 Pompano Beach, FL 33069  
 (954) 984-2400

**Document revisions**

Rev. 0 - Public Release - July 2022