

26
27
27i



E-Chain System® E2 Medium Series 26/27/27i



Price Index



Series 26/27/27i

Special Features / Options



Assembly Tips

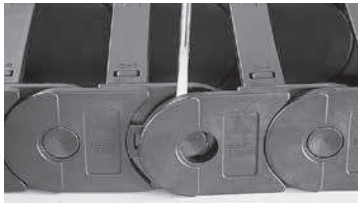
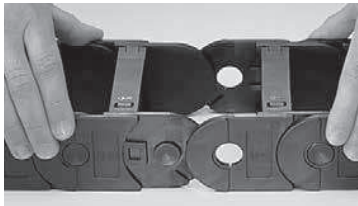

Easy to assemble and disassemble

Other Installation Methods

Vertical, hanging ≤ 164 ft (50 m)

Vertical, standing ≤ 9.84 ft (3 m)

Side-mounted, un_supp. ≤ 3.28 ft (1 m)

Rotary requires further calculation

Usage Guidelines



- If snap-open accessibility along the inner or outer radius is required (Series 200 does not open)
- If stable chain of moderate size is required
- If loads are moderate
- If integrated strain relief at the connection point is required
- If easy installation is required



- If maximum stability is required
 - Series 280, E4/100
- If chip protection is required
 - Series R58, E2 Tubes
- If the application is very simple
 - Series E26, E-Z Chain

Features & Benefits

- 1 Large pins for long service life
- 2 Double stop dog for long unsupported length
- 3 Modular interior separation
- 4 Space-saving ratio of inner-to-outer dimensions
- 5 Lateral glide surfaces for side-mounted operation
- 6 Side wear pads
- 7 Intergrated strain relief possible
- 8 Cable-friendly smooth interior
- 9 Series 27i snap-open along inner radius can be combined with Series 27 snap-open along the outer radius



Order Example: Complete E-Chain®

Please indicate chain length or number of links. Example:

9.84 ft (3 m) 27-10-100-0

E-Chain®

With 2 separators 261 assembled every 2nd link

Interior Separation

1 Set 2610-34PZB

Mounting Bracket

E-Chain System® E2 Medium Series 26/27/27i Installation Dimensions

Short travel, unsupported length

- FL_B = unsupported with permitted sag
 - FL_G = unsupported with straight upper run
- Further information ► Design, Chapter 1

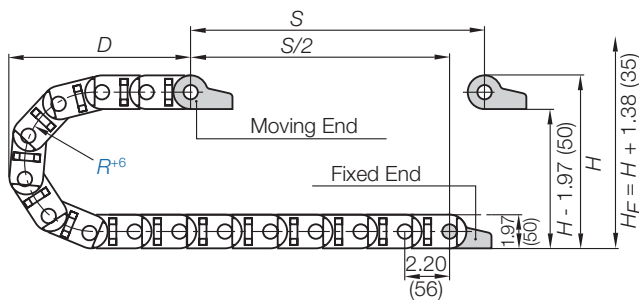
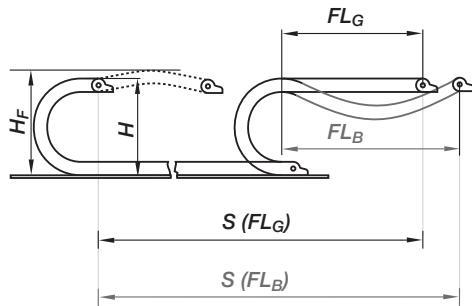

The required clearance height: $H_F = H + 1.38$ in. (35 mm) (with 1.34 lbs/ft (2 kg/m) fill weight). Please consult igus® if space is particularly restricted.

R	2.48 (063)	2.95 (075)	3.94 (100)	4.92 (125)	5.91 (150)	6.89 (175)	7.87 (200)	9.84 (250)
H^{+4}	7.09 (180)	7.87 (200)	9.84 (250)	11.81 (300)	13.78 (350)	15.75 (400)	17.72 (450)	21.65 (550)
D	5.51 (140)	5.91 (150)	6.89 (175)	7.87 (200)	8.86 (225)	9.84 (250)	10.83 (275)	12.80 (325)
K	13.19 (335)	14.76 (375)	18.70 (475)	21.65 (550)	25.59 (650)	29.53 (750)	32.48 (825)	36.42 (925)

For long travels with lowered mounting height

Long travel lengths from 32.8 ft. (10 m) to max. 394 ft. (120 m)

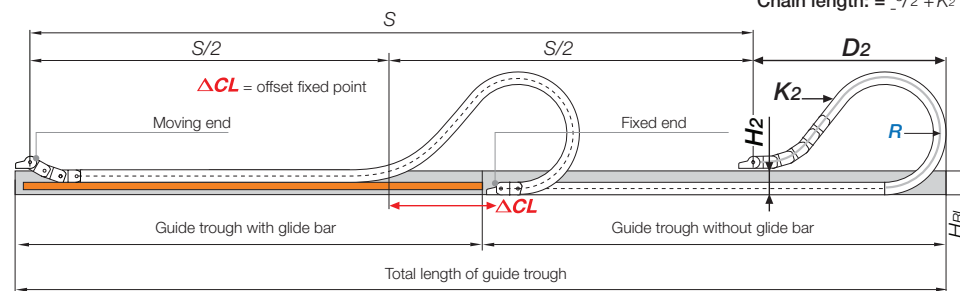

In case of travels between 13 ft. (4m) and 32.8 ft. (10m) we recommend a longer unsupported length.

R	2.48 (063)	2.95 (075)	3.94 (100)	4.92 (125)	5.91 (150)	6.89 (175)	7.87 (200)	9.84 (250)
H^{+4}	—	—	6.54 (166)	6.54 (166)	6.54 (166)	6.54 (166)	6.54 (166)	6.54 (166)
D_2	—	—	13.78 (350)	18.70 (475)	19.69 (500)	25.79 (655)	30.31 (770)	37.40 (950)
K_2	—	—	24.25 (616)	30.87 (784)	35.28 (896)	44.09 (1120)	50.71 (1288)	63.94 (1624)
ΔCL	—	—	5.67 (144)	9.61 (244)	9.61 (244)	14.72 (374)	18.27 (464)	23.39 (594)

Speed / acceleration FL_G	max. 65.6 ft/s (20 m/s) / max. 656 ft/s ² (200 m/s ²)
Speed / acceleration FL_B	max. 9.84 ft/s (3 m/s) / max. 19.69 ft/s ² (6 m/s ²)
Gliding speed / acceleration (maximum)	max. 32.81 ft/s (10 m/s) / max. 164 ft/s ² (50 m/s ²)
Material - permitted temperature	igumid G / -40°F (-40°C) up to +248°F (+120° C)
Flammability Class, igumid G	VDE 0304 IIC UL94 HB

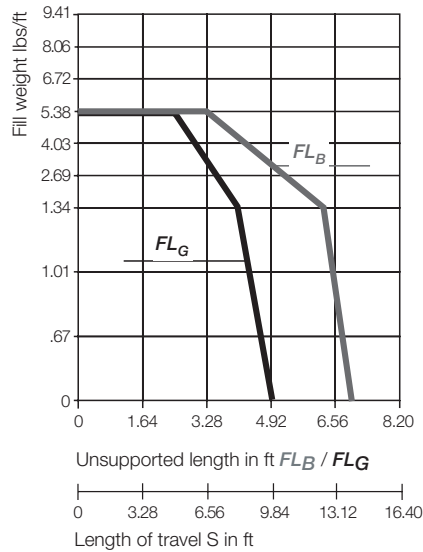

Pitch per link = 2.20" (56 mm)
Links per ft (m) = 5.45 (18)
For center mount applications:
Chain length = $S/2 + K$



26
27
27i

Short Travels - Unsupported



Unsupported E-Chains® feature positive camber over short travels. This must be accounted for when specifying the clearance height. Please refer to Installation dimensions for further details.

Legend

- S = Length of travel
- R = Bending radius
- H = Nominal clearance height
- D = Overlength E-Chain® radius in final position
- $K = \pi \cdot R + \text{safety buffer}$
- H_F = Required clearance height
- HRI = Trough inner height
- H_2 = *Mounting height
- D_2 = Over length - long travels, gliding
- K_2 = *Add-on

*If the mounting bracket location is set lower

Long Travels - Gliding



If the unsupported length is exceeded, the E-Chain®/Tube must glide on itself. This requires a guide trough.

Design, Chapter 1

Technical Data



Details of material properties

► Chapter 1

PDF: www.igus.com/e-chain-pdfs
Specs/CAD/RFQ: www.igus.com/e-chains
RoHS info: www.igus.com/RoHS



4.188

Series 26 - Non snap-open

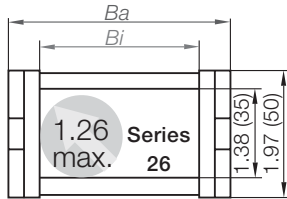

Part Number Structure



Color - Black
Bending radius
Width
Series

Series 27 - Snap-open along the outer radius

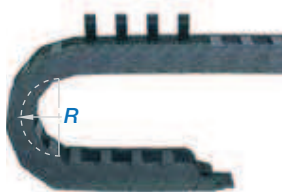
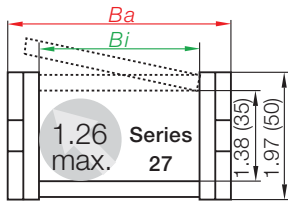

Part Number Structure



Color - Black
Bending radius
Width
Series

Series 27i - Snap open along the inner radius

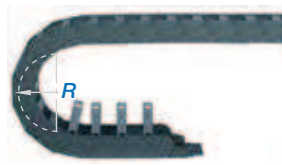
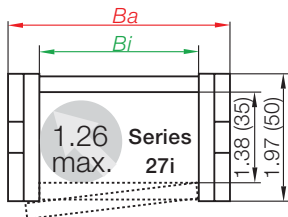

Part Number Structure



Color - Black
Bending radius
Width
Series

Supplement part number with required radius. Example: 26-10-**100**-0
Pitch: 2.20 in. (56 mm) per link links/ft (m) = 5.49 (18)

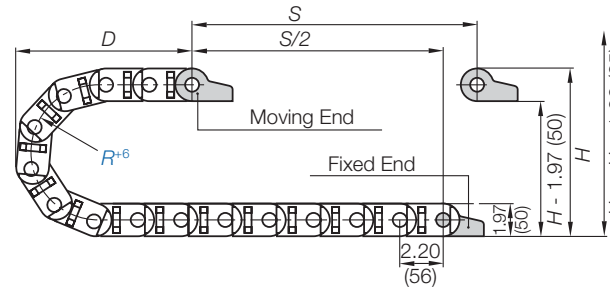

Non Snap-open	Part Number Snap-open Outer Radius	Part Number Snap-open Inner Radius		<i>Bi</i> in. (mm)	<i>Ba</i> in. (mm)	Weight lbs/ft (kg/m)
26-05-	27-05-	27i-05-	<input type="checkbox"/> -0	1.97 (50)	2.60 (66)	≈ 0.79 (1.17)
26-07-	27-07-	27i-07-	<input type="checkbox"/> -0	2.95 (75)	3.58 (91)	≈ 0.87 (1.30)
26-10-	27-10-	27i-10-	<input type="checkbox"/> -0	3.94 (100)	4.57 (116)	≈ 0.93 (1.39)
26-12-	27-12-	27i-12-	<input type="checkbox"/> -0	4.92 (125)	5.55 (141)	≈ 0.99 (1.48)
26-15-	27-15-	27i-15-	<input type="checkbox"/> -0	5.91 (150)	6.54 (166)	≈ 1.09 (1.62)
26-17-	27-17-	27i-17-	<input type="checkbox"/> -0	6.89 (175)	7.64 (194)	≈ 1.24 (1.85)
26-20-	27-20-	27i-20-	<input type="checkbox"/> -0	7.87 (200)	8.62 (219)	≈ 1.32 (1.96)

Choose from the radii below for all of the above sizes
Radius (mm) Example: 26-10-**100**-0

	063	075	100	125	150	175	200	250
R	2.48 (063)	2.95 (075)	3.94 (100)	4.92 (125)	5.91 (150)	6.89 (175)	7.87 (200)	9.84 (250)
H ₊₄	7.09 (180)	7.87 (200)	9.84 (250)	11.81 (300)	13.78 (350)	15.75 (400)	17.72 (450)	21.65 (550)
D	5.51 (140)	5.91 (150)	6.89 (175)	7.87 (200)	8.86 (225)	9.84 (250)	10.83 (275)	12.80 (325)
K	13.19 (335)	14.76 (375)	18.70 (475)	21.65 (550)	25.59 (650)	29.53 (750)	32.48 (825)	36.42 (925)

E-Chain System® E2 Medium Series 26/27/27i Interior Separation



26
27
27i

Option 1: Vertical separators and spacers

Vertical separators are used if a vertical subdivision of the E-Chain® interior is required. By standard, vertical separators are assembled every other E-Chain® link. These separators are the only option when compartmentalizing the interior of the non snap-open E-Chain® such as the Series 26. Both are predominantly used for side-mounted applications.

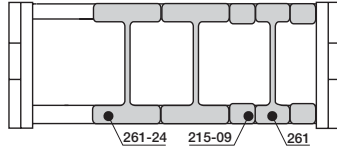

STANDARD

Vertical separator
261

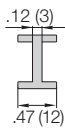

Vertical Separator

Unassembled Part No. 260

Assembled Part No. 261

- **Standard separator 260 for E-Chains®**
This separator is used for general subdivision of E-Chain®.

Vertical separator
260-24

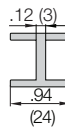

Vertical Separator

Unassembled Part No. 260-24

Assembled Part No. 261-24

- **Standard separator 260-24 for E-Chains®**
This separator features a wide base for use when a large distance between separators is required. These are also used in the case of side mounted applications

Spacers
205-09



Spacer

Unassembled Part No. 205-09

Assembled Part No. 215-09

- **NOTE ON SPACERS**
Vertical separators are adjustable, but can be fixed in position by means of a spacer. Spacers are most often necessary for side mounted applications. The available inner height is reduced by .08" (2mm) **per spacer** (for example if one spacer is placed on either side of the separator, the overall inner height is reduced by .16" (4mm). To avoid this, place the spacers on the **outside** of the opening crossbar (**not for long travels**).

Option 2: Full-width shelf

This option is available for the snap-open Series 27/27i chains. It is ideal for use in applications involving many thin cables with similar or identical diameters. This shelf slides into place and spans the entire width of the chain.

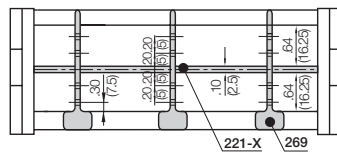

Slotted vertical separator
268

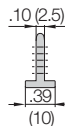

Vertical Separator

Unassembled Part No. 268

Assembled Part No. 269

- **Slotted separator 268 for E-Chains®**
This component is used to form the basic pattern of a shelf system.

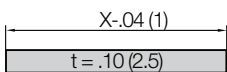

Width X in. (mm)	Part No. Unassembled	Part No. Assembled
1.97 (50)	220-50	221-50
2.95 (75)	220-75	221-75
3.94 (100)	220-100	221-100
4.92 (125)	220-125	221-125
5.91 (150)	220-150	221-150
6.89 (175)	220-175	221-175
7.87 (200)	220-200	221-200

PDF: www.igus.com/e-chain-pdfs
Specs/CAD/RFQ: www.igus.com/e-chains
RoHS info: www.igus.com/RoHS





E-Chain System® E2 Medium Series 26/27/27i Interior Separation

igus® E-Chain
System®

Telephone 1-800-521-2747
Fax 1-401-438-7270

Internet: <http://www.igus.com>
email: sales@igus.com
QuickSpec: <http://www.igus.com/quickspec>

Option 3: Shelves

This option is available for the Series 27/27i snap-open chains. It is ideal for use in applications involving many cables with different diameters. This option allows for variable compartment heights and widths across the chain width, but can also be used for level separation across the entire width.

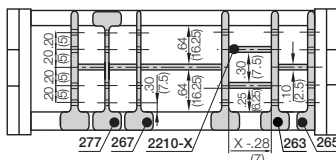
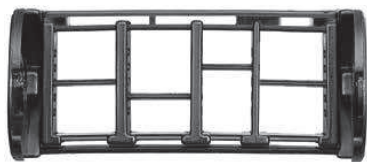

Side plate
264

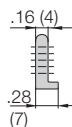

Side plate

Unassembled	Part No. 264
Assembled	Part No. 265

- **Side plate 264 for E-Chains®**
This component is used to form the basic pattern of a shelf system.

Vertical separator
262

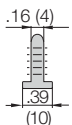

Vertical Separator

Unassembled	Part No. 262
Assembled	Part No. 263

- **Slotted separator 262 for E-Chains®**
This component is used to form the basic pattern of a shelf system.

Closed slotted separator
266

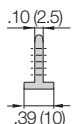

Vertical Separator

Unassembled	Part No. 266
Assembled	Part No. 267

- **Closed slotted separator 266 for E-Chains®**
These are used for complex subdivisions. However, they cannot be retrofitted into an existing interior separation system without removing the shelves first.

Open slotted separator
276

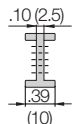

Vertical Separator

Unassembled	Part No. 276
Assembled	Part No. 277

- **Open slotted separator 276 for E-Chains®**
This separator can be retrofitted into an existing interior separation system without removing the shelves, as long as these shelves fit into the 5 middle slots only.

Width X in. (mm)	Part No. Unassembled	Part No. Assembled
.71 (18)	2200-18	2210-18
.91 (23)	2200-23	2210-23
1.10 (28)	2200-28	2210-28
1.30 (33)	2200-33	2210-33
1.50 (38)	2200-38	2210-38
1.69 (43)	2200-43	2210-43
1.89 (48)	2200-48	2210-48
2.28 (58)	2200-58	2210-58
2.68 (68)	2200-68	2210-68
2.87 (73)	2200-73	2210-73
3.46 (88)	2200-88	2210-88
3.90 (99)	2200-99	2210-99
4.88 (124)	2200-124	2210-124

Shelves 2200-XX

These components form the basic pattern of a shelf system. Shelves of various widths can be arranged at 5 different heights in .20" (5mm) increments

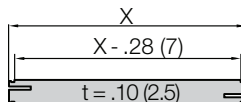

E-Chain System® E2 Medium Series 26/27/27i Mounting Brackets - Plastic



26
27
27i

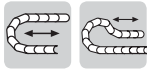

Standard

Option 1: pivoting

- Short and long travels
- Space-restricted conditions
- Corrosion resistant

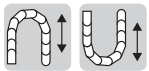
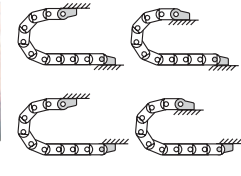
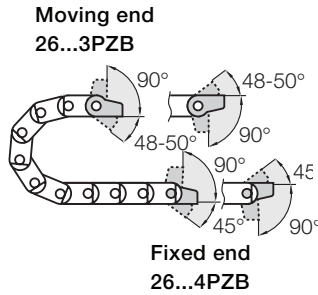

Option 2: locking

- Vertical hanging/standing travels
- Extreme accelerations
- Corrosion resistant

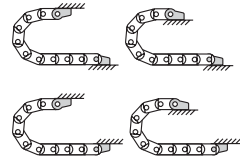
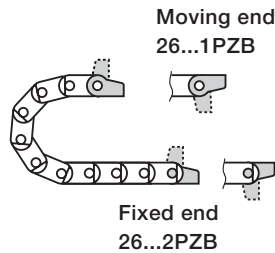

Part Number Structure

2605- 34 PZB 1

- With 10 cable tieswraps
- With tiewrap plates
- Complete Set
34 = Pivoting
12 = Locking
- Mounting brackets for selected chain type

Full set, for both ends:

2605- 34 PZB Full set, each part with pin/bore + tiewrap plate

Single-part order:

2605- 3 PZB Mounting bracket with bore + tiewrap plate

2605- 4 PZB Mounting bracket with pin + tiewrap plate

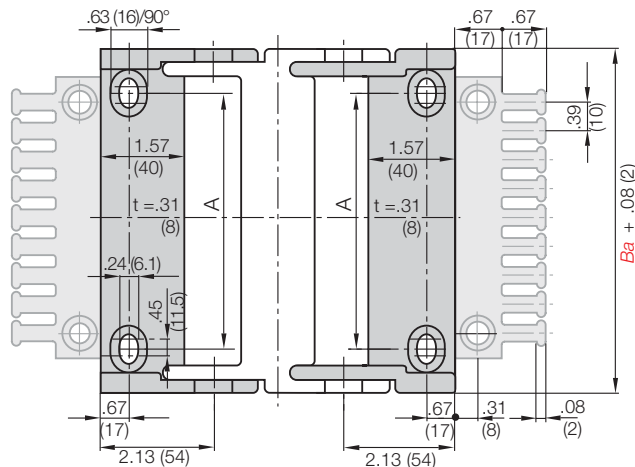

Part No. Full Set (pivoting)

With Tiewrap Plates

Series 26, 27 or 27i:

2605-34PZB

Part No. Full Set (pivoting)

With Tiewrap Plates + 10 cable ties

Series 26, 27 or 27i:

2605-34PZB1

Part No. Full Set (pivoting)

Without Tiewrap Plates

Series 26, 27 or 27i:

2605-34PZ

For Chain Type	Part No. Full Set with Tiewrap Plate	Part No. Full Set with Tiewrap Plate + 10 cable ties	Part No. Full Set without Tiewrap Plate	Dimension A
				in. (mm)
26/27/27i-05	2605- <input type="checkbox"/> PZB	2605- <input type="checkbox"/> PZB1	2605- <input type="checkbox"/> PZ	1.18 (30)
26/27/27i-07	2607- <input type="checkbox"/> PZB	2607- <input type="checkbox"/> PZB1	2607- <input type="checkbox"/> PZ	2.17 (55)
26/27/27i-10	2610- <input type="checkbox"/> PZB	2610- <input type="checkbox"/> PZB1	2610- <input type="checkbox"/> PZ	3.15 (80)
26/27/27i-12	2612- <input type="checkbox"/> PZB	2612- <input type="checkbox"/> PZB1	2612- <input type="checkbox"/> PZ	4.13 (105)
26/27/27i-15	2615- <input type="checkbox"/> PZB	2615- <input type="checkbox"/> PZB1	2615- <input type="checkbox"/> PZ	5.12 (130)
26/27/27i-17	2617- <input type="checkbox"/> PZB	2617- <input type="checkbox"/> PZB1	2617- <input type="checkbox"/> PZ	6.10 (155)
26/27/27i-20	2620- <input type="checkbox"/> PZB	2620- <input type="checkbox"/> PZB1	2620- <input type="checkbox"/> PZ	7.09 (180)

34 or 12

For pivoting brackets choose 34
For locking brackets choose 12
Example: 2605- 34 PZB



Cable tiewraps as individual parts

Cable tiewraps 100 pieces/bag	Width x Length		Maximum Ø		Tensile Strength	
	in.	(mm)	in.	(mm)	lbs	(N)
CFB-001	.19	5.91 (4.8 x 150)	1.42	(36)	50	(222)

PDF: www.igus.com/e-chain-pdfs
Specs/CAD/RFQ: www.igus.com/e-chains
RoHS info: www.igus.com/RoHS



E-Chain System® E2 Medium Series 26/27/27i Mounting Brackets - KMA

igus® E-Chain
System®

Telephone 1-800-521-2747
Fax 1-401-438-7270

Internet: <http://www.igus.com>
email: sales@igus.com
QuickSpec: <http://www.igus.com/quickspec>

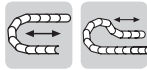

Standard

Option 1: pivoting

- Short and long travels
- Optional integrated profile rail for strain relief
- Bolted connection outside of chain cross section
- Space-restricted conditions
- Corrosion resistant
- Universal use

Moving end
2600...1

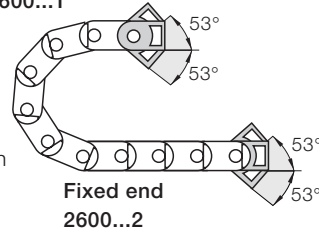

Fixed end
2600...2

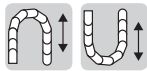

Option 2: locking

- Vertical hanging/standing travels
- Optional integrated profile rail for strain relief
- Bolted connection outside of chain cross section
- Extreme accelerations
- Corrosion resistant
- Universal use

Moving end
2700...1

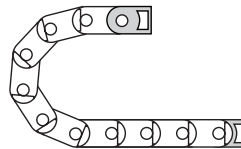

Fixed end
2700...2



Part Number Structure

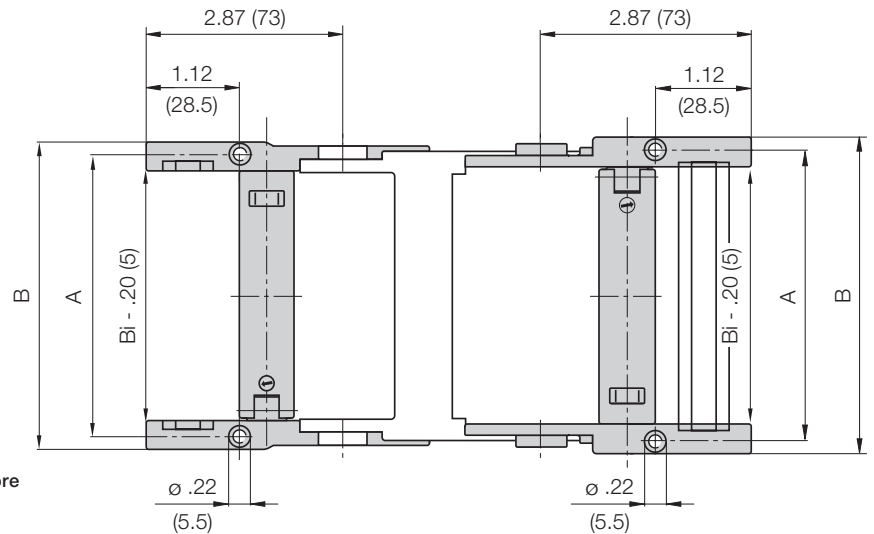
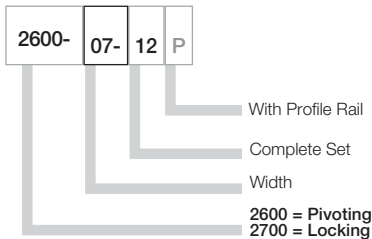

Full set, for both ends:

2600- 07- 12 Full set, each part with pin/bore

Single-part order:

2600- 07- 1 Mounting bracket with bore

2600- 07- 2 Mounting bracket with pin

Part number examples are shown for pivoting brackets. For locking brackets change part number to 2700

Part No. Full Set (pivoting)

Series 26/27/27i:

2600-Width-12

Part No. Full Set (pivoting)

with profile rail

Series 26/27/27i:

2600-Width-12P

Width	Part No. Full Set		With Profile Rail	Dimension A		Dimension B	
	Pivoting	Locking		in.	(mm)	in.	(mm)
-05	2600	2700	-05-12	2.28	(58)	2.72	(69)
-07	2600	2700	-07-12	3.27	(83)	3.70	(94)
-10	2600	2700	-10-12	4.25	(108)	4.69	(119)
-12	2600	2700	-12-12	5.24	(133)	5.67	(144)
-15	2600	2700	-15-12	6.22	(158)	6.65	(169)
-17	2600	2700	-17-12	7.20	(183)	7.64	(194)
-20	2600	2700	-20-12	8.19	(208)	8.62	(219)

E-Chain System® E2 Medium Series 26/27/27i Mounting Brackets - Steel



26
27
27i



Option 1: Steel

- Pivoting connections
- One part (two-piece) for all chain widths
- Electrically conductive
- Bolted connection outside of chain cross-section possible

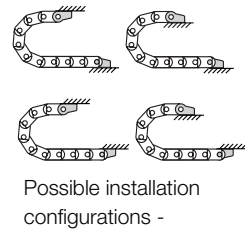
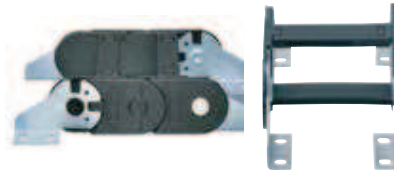
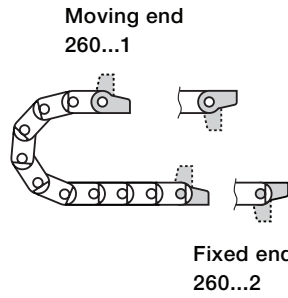

Possible installation configurations -

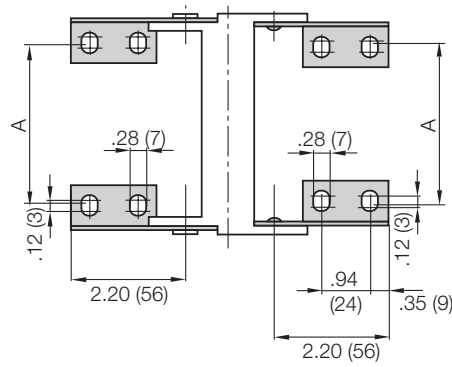
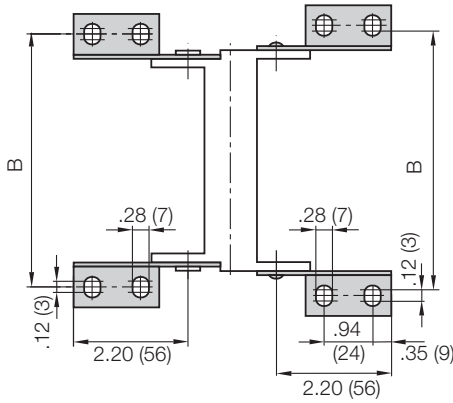

Chain Type	Part No. Full Set	Dimension A		Dimension B	
		in.	(mm)	in.	(mm)
26/27/27i-05	260-12	1.44	(36.5)	3.31	(84)
26/27/27i-07	260-12	2.44	(62)	4.25	(108)
26/27/27i-10	260-12	3.43	(87)	5.24	(133)
26/27/27i-12	260-12	4.41	(112)	6.22	(158)
26/27/27i-15	260-12	5.39	(137)	7.20	(183)
26/27/27i-17	260-12	6.42	(163)	8.23	(209)
26/27/27i-20	260-12	7.40	(188)	9.21	(234)

Part No. Mounting Brackets Full Set

4 parts, 2 with pin, 2 with bore
Series 26/27/27i:

260-12

Part No. Mounting Bracket Moving End

2 parts, 1 left & 1 right
Series 26/27/27i:

260-1

Part No. Mounting Bracket Fixed End

2 parts, 1 left & 1 right
Series 26/27/27i:

260-2

PDF: www.igus.com/e-chain-pdfs
Specs/CAD/RFQ: www.igus.com/e-chains
RoHS info: www.igus.com/RoHS



Chainfix clamps for the profile rail



igus® Chainfix strain relief elements are available in either steel or stainless steel. They can be adjusted with a hexagon socket and are available in single, double and triple configurations.

Part No. Single Clamp		Part No. Double Clamp		Part No. Triple Clamp		Cable ø	
Steel	Stainless	Steel	Stainless	Steel	Stainless	in.	(mm)
CFX12-1	CFX12-1E	CFX12-2	CFX12-2E	CFX12-3	-	.24 - .47	(06 - 12)
CFX14-1	CFX14-1E	CFX14-2	CFX14-2E	CFX14-3	-	.47 - .55	(12 - 14)
CFX16-1	CFX16-1E	CFX16-2	CFX16-2E	CFX16-3	-	.55 - .63	(14 - 16)
CFX18-1	CFX18-1E	CFX18-2	CFX18-2E	CFX18-3	-	.63 - .71	(16 - 18)
CFX20-1	CFX20-1E	CFX20-2	CFX20-2E	CFX20-3	-	.71 - .79	(18 - 20)
CFX22-1	CFX22-1E	CFX22-2	CFX22-2E	CFX22-3	-	.79 - .87	(20 - 22)
CFX26-1	CFX26-1E	CFX26-2	CFX26-2E	-	-	.87 - 1.02	(22 - 26)
CFX30-1	CFX30-1E	CFX30-2	CFX30-2E	-	-	1.02 - 1.18	(26 - 30)
CFX34-1	CFX34-1E	CFX34-2	CFX34-2E	-	-	1.18 - 1.34	(30 - 34)
CFX38-1	CFX38-1E	-	-	-	-	1.34 - 1.50	(34 - 38)
CFX42-1	CFX42-1E	-	-	-	-	1.50 - 1.65	(38 - 42)

For more information please refer to strain relief section of Chapter 10

Chainfix Clip



Modular snap-on strain relief device

Chainfix clip is available for cable diameters ranging from .16" (4mm) to .94" (24 mm). It is suitable for assembly on KMA mounting brackets, clip-on strain relief for crossbars as well as profile rails. Quick assembly without the use of tools. **For more information please refer to strain relief section of Chapter 10**

Cable ø	Part No. Clamp	Part No. Bottom
in. (mm)		
.16-.31 (04-08)	CFC-08-M	CFC-08-C
.31-.47 (08-12)	CFC-12-M	CFC-12-C
.47-.63 (12-16)	CFC-16-M	CFC-16-C
.63-.79 (16-20)	CFC-20-M	CFC-20-C
.79-.94 (20-24)	CFC-24-M	CFC-24-C

Tiewrap Plates

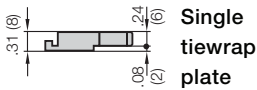
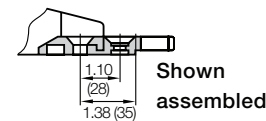

Option 1:

Tiewrap plates as an individual part

Available as an individual component, can be fixed onto a mounting bracket with the use of a profile rail.

Tiewrap Plate	n Number of Teeth	C Overall Width in. (mm)	B Bore Width in. (mm)	Center Bore
3050-ZB	5	1.97 (50)	1.18 (30)	no
3075-ZB	7	2.95 (75)	2.16 (55)	no
3100-ZB	10	3.94 (100)	3.15 (80)	no
3115-ZB	11	4.53 (115)	3.74 (95)	no
3125-ZB	12	4.92 (125)	4.13 (105)	no
3150-ZB	15	5.91 (150)	5.12 (130)	no
3175-ZB	17	6.89 (175)	6.10 (155)	no
3200-ZB	20	7.87 (200)	7.09 (180)	yes
3225-ZB	22	8.86 (225)	8.07 (205)	yes
3250-ZB	25	9.84 (250)	9.06 (230)	yes

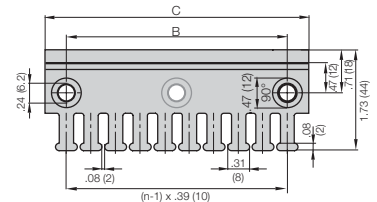

For more information please refer to strain relief section of Chapter 10



Option 2:

Clip-on Tiewrap plates

Available as a clip-on tiewrap plate without the use of bolts They are inserted and removed with a screwdriver used as a lever. Clip-on tiewrap plates are also available as an attachment to the opening crossbars.

Part No.	Number of Teeth	Width of Strain Relief in. (mm)
3050-ZC	5	1.97 (50)
3075-ZC	7	2.95 (75)

For more information please refer to strain relief section of Chapter 10



Option 3:

Clip-on Tiewrap plates for opening crossbars

Clip-on tiewrap plates are also available as an attachment to opening crossbars. They can be positioned at any point along the E-Chain®.

Part No.	Number of Teeth	Width of Strain Relief in. (mm)
2050-Z	6	2.36 (60)

For more information please refer to strain relief section of Chapter 10

E-Chain System® E2 Medium Series 26/27/27i Guide Trough



26
27
27i

Guide troughs are used with applications where the upper run of the E-Chain® glides on the lower run. If using igus® steel guide troughs, the following components are required:

- Full travel length of guide trough
Part Number 95-30
- 1/2 travel length of glide bars
Part number 92-01
- Installation sets as end connectors
Part Number 95-50-XX

-XX indicates the length of the profile rail on which the guide trough is mounted. The values and part numbers are specified in the table on the left. The standard length of the trough components and glide bars is 6.56 ft (2 m). The required overall length of the guide trough directly correlates to the length of travel.

Example:

Length of travel 164 ft (50 m)
Center mounted

Required guide troughs:

164 ft (50 m) guide trough
82 ft (25 m) glide bar
= 25 sections of 6.56 ft (2 m) guide trough

Part No. 95-30

= 13 sections of 6.56 ft (2 m) glide bar

Part No. 92-01

Required number of installation sets:

= Number of guide trough components + 1

= 25 + 1 = 26

Part number of the installation sets

Example: 95-50-400 for 15.75" (400 mm) long profile rail.



Width of Crossbar
27-05-200-0

	B_{Ri}	Installation Part No.
-05	2.80 (71)	95-50-200
-07	3.78 (96)	95-50-200
-10	4.76 (121)	95-50-250
-12	5.75 (146)	95-50-250
-15	6.73 (171)	95-50-300
-17	7.83 (199)	95-50-300
-20	8.82 (224)	95-50-350

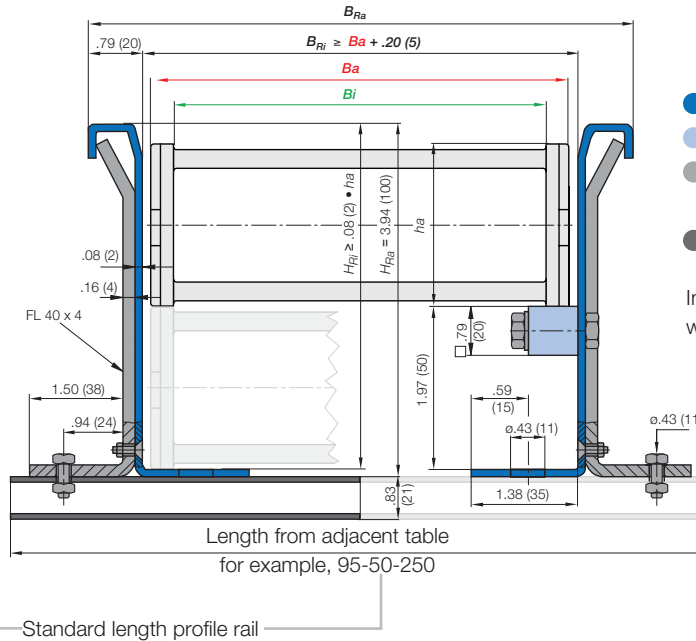

* Specialized guide trough available upon request

PDF: www.igus.com/e-chain-pdfs
 Specs/CAD/RFQ: www.igus.com/e-chains
 RoHS info: www.igus.com/RoHS

